



# Origin Software General Survey User Guide



# Contents

<b>Get started</b> .....	<b>5</b>
Supported equipment .....	6
Software setup and installation .....	13
To sign in .....	18
The Origin workspace .....	20
Favorite screens and functions .....	24
Keypad shortcuts .....	28
Status bar .....	32
<b>Projects &amp; jobs</b> .....	<b>39</b>
Managing projects .....	42
Managing jobs .....	54
Job properties .....	73
<b>Job data</b> .....	<b>112</b>
Selecting points .....	112
Layer manager .....	115
Map .....	127
Working with media files .....	182
Reviewing data .....	186
Data quality graph .....	214
<b>Key in &amp; Cogo</b> .....	<b>216</b>
Construction points .....	216
Keying in data .....	216
Cogo calculations .....	228
<b>Conventional surveys</b> .....	<b>277</b>
To configure the conventional survey style .....	277
To set up and connect the instrument .....	288
To start the conventional survey .....	289
Station setup .....	295
Targets .....	314
Instrument functions and settings .....	322
<b>GNSS surveys</b> .....	<b>342</b>
To configure the GNSS survey style .....	344
To set up and connect the GNSS receiver .....	365
To start and end the GNSS survey .....	376

Site calibration .....	390
Receiver functions and settings .....	400
<b>Integrated surveys .....</b>	<b>420</b>
To configure the integrated survey style .....	420
To start and end an integrated survey .....	421
To start an integrated survey using a station elevation setup .....	422
To switch between instruments .....	423
To change the antenna or prism height during an integrated survey .....	424
<b>Additional survey equipment .....</b>	<b>426</b>
Laser rangefinders .....	426
Echo sounder instruments .....	429
<b>Connections .....</b>	<b>432</b>
Bluetooth connections .....	433
Radio connections .....	436
Auto-connect settings .....	437
GNSS contact settings .....	439
Internet connection setup .....	439
<b>Conventional survey measure methods .....</b>	<b>446</b>
To measure a topo point .....	446
To measure rounds of observations .....	457
To measure to a surface .....	460
To measure points on a plane .....	461
To measure a point relative to a 3D axis .....	463
To measure continuous topo points .....	465
Surface scanning .....	466
<b>GNSS survey measure methods .....</b>	<b>470</b>
To measure a topo point .....	471
To measure continuous topo points .....	472
To measure an observed control point .....	474
To measure rapid points .....	475
To measure a MultiTilt point .....	476
To measure to a surface .....	479
To measure a check point .....	481
To measure a compensated point .....	481
To measure FastStatic points .....	482
Measurement messages and warnings .....	483

<b>Measuring points with feature codes</b> .....	<b>485</b>
To select feature codes .....	485
To enter attribute values when measuring a point .....	487
To link an image to an attribute .....	488
To resurvey points that already have attributes .....	490
Measuring and coding observations in one step .....	490
<b>Stakeout</b> .....	<b>499</b>
To stake out an item .....	499
Stake out items list .....	500
Stakeout navigation .....	503
To stake out points .....	515
To stake out a line .....	520
To stake out a polyline .....	524
To stake out an arc .....	529
To stake out an alignment .....	533
To stake out to the design elevation .....	544
To show the cut/fill to a DTM during stakeout .....	545
To stake out a DTM .....	546
<b>Glossary</b> .....	<b>547</b>

## Get started

Spectra Geospatial Origin is a new, modern field software supporting complete land survey workflows for all your projects and jobs. Intuitive and reliable, Origin provides map-based workflows for one-tap, easy-to-use measuring, feature coding, coordinate geometry calculation, and stakeout.

The Origin software supports both the Windows® and Android™ operating systems and can be installed to a range of supported Spectra Geospatial controllers. Depending on your software license type, you can use Origin with GNSS receivers, conventional robotic or mechanical instruments, or maximize the advantages of both GNSS and conventional in an integrated survey.

Cloud connectivity enables data to be shared easily between field and office.

The basic steps for getting data onto your controller and completing your fieldwork are:

1. **Load files onto the controller.**

Transfer files from your office computer using a network connection, cable, or USB drive, or simply download a project from the cloud. See [File transfer, page 50](#).

2. **Open the project and the job.**

Download projects and jobs from the cloud and open them, or create projects and jobs locally on the controller. See [Projects & jobs, page 39](#).

3. **Set up the survey style for your equipment.**

Configure connection settings for your equipment and your preferences for points measured using that equipment. The survey style can be reused for any job that uses the same equipment. Then set up your equipment on-site and start the survey.

4. **Measure or stake out points.**

Origin provides a wide range of methods for measuring points. See [Conventional survey measure methods , page 446](#) and [GNSS survey measure methods, page 470](#).

Stake out points, lines, arcs, polylines, alignments or digital terrain models (DTMs). See [Stakeout, page 499](#).

## 5. Add other data to the job, as required.

Use other Origin functions to capture images, perform Cogo calculations or key in points. See [Key in & Cogo, page 216](#).

## 6. Review your data.

Use the **Point Manager** to view tabulated data point by point or **Review job** to view a summary of the points collected in the job. See [Reviewing data, page 186](#).

## 7. Distribute your data.

Export data to different file formats for office processing or sharing with others, or generate reports. See [To export data from the job, page 64](#).

Transfer the job or project to the office, or synchronize the data to the cloud.

## Supported equipment

The Origin software can be used with the following equipment.

**TIP** – To test, demonstrate, or deliver training with Origin using a simulated connection to a GNSS receiver, see [To simulate a connection to a GNSS receiver, page 9](#). To simulate running the software on a supported controller, see [To simulate a controller, page 7](#).

### Supported controllers

#### Windows devices

The Origin software runs on the following Windows devices:

- Spectra Geospatial Ranger 7 data collector
- Spectra Geospatial ST10 or ST100 tablet

#### Android devices

The Origin software runs on the following Android devices:

- Spectra Geospatial Ranger 5 data collector
- Spectra Geospatial MobileMapper 60 handheld

**TIP** – Origin is designed to be used in **Portrait mode** or in **Landscape mode** on the MobileMapper 60 handheld. There are small differences in the UI to accommodate the portrait screen and the Android operating system. See [Screen orientation, page 22](#).

**NOTE** – A small number of features are not supported when running Origin on an Android device. See [Tips for Android devices, page 24](#).

### Supported conventional instruments

Conventional instruments that can be connected to the controller running Origin are:

- Spectra<sup>®</sup> Geospatial motorized total stations: FOCUS<sup>®</sup> 35/30
- Supported Nikon and third-party total stations

The functionality available in the Origin software depends on the model and firmware version of the connected instrument. Spectra Geospatial recommends updating the instrument to the latest available firmware to use this version of Origin.

### Supported GNSS receivers

GNSS receivers that can be connected to the controller running Origin are:

- Spectra Geospatial integrated GNSS receivers: SP60, SP80, SP85
- Spectra Geospatial modular GNSS receivers: SP90m

### Other supported equipment

If required, you can use additional devices when surveying, such as:

- laser rangefinders
- echo sounders
- barcode readers

If your controller supports a barcode reader you can use it to fill out the current field, for example a **Code** field. When using a Ranger 7 fitted with the EMPOWER barcode reader module, use the EMPOWER Asset settings application on the controller to enable the barcode reader and select the trigger button.

To use a laser rangefinder or echo sounder, you must configure the survey style. See [Additional survey equipment, page 426](#).

### To simulate a controller

If you are running the Origin software on a **Windows desktop computer or laptop**, you can use the **Simulate controller** function to simulate running the software on a supported controller. This feature allows you to demonstrate the software or capture screenshots of the software with your preferred controller layout for inclusion in training materials.

You can use the **Simulate controller** function in conjunction with:

- the **GNSS emulator** function to [simulate a connection to a GNSS receiver](#), removing the need to be outdoors and connected to a real GNSS receiver.
- a **manual survey style** you have set up to [simulate a connection to a conventional instrument](#), removing the need to be connected to a real instrument.

1. Start Origin.
2. Tap  and select **About / Support / Simulate controller**.
3. In the **Simulate device** menu select the controller type. The software reconfigures itself to simulate how it appears when running on the selected device.

**TIP** – To start simulating a device from anywhere in the software, use the keypad shortcut **Ctrl + Shift + S** and then select the controller type.

**NOTE** – *You can select an Android controller such as the MobileMapper 60 as the controller type when running Origin on a Windows computer, but note that where Origin interacts with parts of the computer operating system, the simulator can only show the Windows operating system behavior, not Android.*

4. By default the Origin window is shown at the size it appears on the device. To resize the window:
  - a. Tap  and select **About / Support / Simulate controller**.
  - b. In the **Simulate controller** menu select **DPI scaling**.
  - c. In the **DPI scaling mode** field, select **Custom**.
  - d. Enter the new **DPI scaling value**. You can enter a different value for each device type.

**TIP** – When simulating a portrait device on a landscape screen, enter **0.8** or similar to fit the entire window on the screen.

- e. Restart the Origin software to view the simulator at the new size.

When the software starts, a tooltip displays the device type of the simulated controller and the DPI scaling value used, if it is a custom value.

5. To hide or display the Windows title bar, tap  and select **About / Support / Simulate controller / Show title bar**. Restart the Origin software to apply the change.



**TIP** – To move the Origin window when the Windows title bar is not shown, click inside the status line area and drag the window. You must have opened a job to see the status line area of the status bar.

6. To hide or display the Android navigation bar, tap  and select **About / Support / Simulate controller / Show Android buttons**. Restart the Origin software to apply the change.

When you simulate an Android device, you can use the Android Back button  as an **Esc** softkey to leave the current Origin software screen. Because the Android Menu button operates the Android operating system menu, tapping/clicking the Android Menu button has no effect when using the simulator.

**NOTE** – *When you simulate a device that does not have a physical keypad, the on-screen keyboard appears when editing text. Function keys and associated shortcut keys are not supported on devices that do not have a physical keypad. Tapping/clicking a Favorite star toggles the Favorite function on and off, instead of showing the Favorite menu.*

#### To simulate a connection to a GNSS receiver

The GNSS emulator allows you to test, demonstrate, or deliver training with Origin using a simulated connection to a GNSS receiver. This removes the need to be outdoors and connected to a real GNSS receiver.

The GNSS emulator can be used on controllers or desktop computers that have Origin installed.

#### **NOTE** –

- *The GNSS emulator is a pre-recorded set of output from a receiver and cannot change based on real-time commands from the software. This means that some functions cannot be used with the GNSS emulator, including tilt compensation, re-initialization, tracking resets, and SV subsets.*
- *While a job does not need to be open to simulate a device, you must **open a job** before you can use the GNSS emulator.*
- *The GNSS emulator function is not supported when Origin is running on an Android device.*

## To start the GNSS emulator

1. In Origin, open the project and job you want to work in.

**NOTE** - The GNSS emulator function cannot be used with the default coordinate system, which is **Scale 1.000**. You must open a job that uses a fully defined a coordinate system, such as any coordinate system selected from the coordinate system library provided with the software.

2. Tap  and select **About / Support / GNSS emulator**. The **GNSS emulator** form appears next to the map.

**TIP** - The GNSS emulator item does not appear in the **Support** menu until you have opened a job.

If you frequently use the GNSS emulator, tap  and add it to your list of **Favorite** items. See [Favorite screens and functions](#).

3. Configure the location of the base receiver. You can:
  - Enter coordinates that are appropriate for the coordinate system settings defined for the job.
  - Tap inside one of the coordinate fields and then use the **Select** tool  on the map toolbar to select a position on the map. The coordinate fields are updated with the coordinates of the selected position.
4. Configure the starting location of the rover.
5. From the **Receivers** list, select the receiver type.
6. To be able to change the position of the rover using the GNSS joystick, select the **GNSS joystick** check box.
7. Tap **Accept**.

The **GNSS Emulator** form closes and the emulator starts. The icons in the status bar indicate the software is connected to the GNSS receiver.

The **GNSS Emulator** DOS window appears alongside the Origin window. You must keep this window open while you are using the GNSS emulator.

If you selected the **GNSS joystick** check box, the **GNSS joystick** pop-up window also appears in Origin.

#### To use the GNSS emulator

1. To start the GNSS RTK survey, do one of the following:

- Tap a point on the map to select it and then tap **Stakeout**.
- Tap **☰** and select **Measure / RTK / Measure points** or **Measure codes**.

2. Tap **Accept** to accept all of the default settings for the emulator receiver.

The survey starts just like when Origin is connected to a real receiver. The status line on the status bar updates, indicating the survey has started. In the map, the base position and the current rover location (indicated by the green cross) appear.

3. Measure a point or stake out the selected point.

4. To change the position of the rover, tap and hold on the map and select **Move rover here**, or use the GNSS joystick.

If the **GNSS joystick** pop-up window is not already shown, tap and hold on the map and select **GNSS joystick**.

In the **GNSS joystick** pop-up window, the current location of the rover is at the center of the position circle in the  $\lambda, \phi$  tab.

- To change the horizontal position of the rover, tap anywhere in the **Position** circle. For example, tap on the inner circle to move the rover 1 m in that direction.

After a small delay, the map shows the new position of the rover.

- To change the vertical position of the rover antenna, tap in the **Height** tile.
- To reduce the scale used by the **GNSS joystick** by a factor of 10, for example from 1.0 m to 0.1 m, select the **Fine** check box. This change applies to both the **Position** and **Height** tiles.
- To change the precision of the rover position, select the  $\sigma$  tab. The default option is **Precise**.

- To change the amount of tilt of the pole, select the  $\theta$  tab. Tap the **eBubble** softkey to open the eBubble to see the effect of changing the amount of tilt.
5. Continue measuring or staking out points as usual.
  6. To end the survey, tap the receiver icon on the status bar and then tap **End survey** in the **GNSS functions** screen.
  7. When prompted, choose whether to power down the receiver.
    - Tap **Yes** to disconnect from the simulated receiver and close the **GNSS Emulator** DOS window.
    - Tap **No** to keep the GNSS Emulator running and stay connected to the receiver (for example, if you want to start a new survey).

### To simulate a connection to a conventional instrument

You can simulate a connection to a basic conventional instrument to make manual observations to test, demonstrate, or deliver training with Origin. This can be useful when you don't have access to a physical instrument.

1. Tap  $\equiv$  and select **Settings / Survey styles**.
2. Tap **New**.
  - a. Enter a name for the style, for example **Manual Instrument**.
  - b. In the **Style type** field, select **Conventional**.
  - c. Tap **Accept**.

The survey style settings pages for the survey style you created are listed.

3. Select **Instrument** and tap **Edit**.
  - a. In the **Manufacturer** field, select **Manual**.
  - b. In the **Instrument precisions** group box, modify the angle precision and EDM precision thresholds as required.

You can also modify the **Instrument centering error** and **Backsight centering error**. This can

be used in an adjustment carried out in Survey Office.

- c. Tap **Accept**.
4. Tap **Store**. The changes you made to the survey style are saved.
5. Tap ☰ and select **Measure / [survey style name] / Station setup**.
  - a. In the **Corrections** screen, key in the corrections you would like to simulate. Tap **Accept**.
  - b. Define the instrument point. Either select a point in the job or, if you do not have any points in the job, key in the point details. Tap **Accept**.
  - c. Define the backsight point. Either select a point in the job or, if you do not have any points in the job, key in the point details. Select the measurement **Method**. Tap **Measure**.
  - d. Because the software is not connected to a real instrument you must key in the **Manual observation**. Enter the **Horizontal angle** and the **Vertical angle**. Tap **Accept**.

Just as you would when working with a real instrument, you can now view and confirm the measurement before storage.
  - e. Tap **Store**.

The station set up is now complete and you are ready to survey.
6. Measure points or stake out points as usual.
7. Tap ☰ and select **Measure / End conventional survey**. Tap **Yes** to confirm.

## Software setup and installation

To install and use the Origin software you must have a license or a subscription for the General Survey app and each Origin app you want to use. If you have a subscription, you must sign in using your Trimble ID before you can use the software.

To install or update Origin software to your controller, use Spectra Geospatial Installation Manager:

- If the controller is a Windows device, install or update Origin software using Spectra Geospatial Installation Manager for Windows. For more information, refer to the [Spectra Geospatial Installation Manager for Windows Help](#).

- If the controller is an Android device, install or update Origin software using Spectra Geospatial Installation Manager for Android. For more information, refer to the [Spectra Geospatial Installation Manager for Android Help](#).

**NOTE** – Spectra Geospatial Installation Manager for Android must remain installed on the controller for the Origin software to run. On a Windows device, Spectra Geospatial Installation Manager for Windows can be installed and uninstalled as required, without affecting the Origin software.

To access a list of all Origin apps installed on the controller, their version numbers and license information, tap  and select **About**.

### License type and expiry date

The **About** screen lists the license information for all Origin apps installed on the controller:

- A **Full** license is delivered to the device serial number and works perpetually (there is no expiry date).
- A **Timed** license is delivered based on the device serial number and will stop working on the date shown in the **Expiry** column.
- A **Subscription** is delivered based on the signed in Trimble ID and will stop working on the date shown in the **Expiry** column.

**NOTE** – To use Origin apps for which you have a subscription, you must [sign in using your Trimble ID](#). Subscriptions are locked to the controller until you sign out. To use your Origin subscriptions on a different controller, you must **sign out** on the current controller.

### Software warranty expiry date

The **Software warranty expiry** is the date the Software Maintenance warranty expires. New improved versions of the software require a valid warranty. If the software warranty has expired, you can continue to operate the software and are entitled to only minor updates of the software.

The **Software warranty expiry** date is shown only if you have a **Full** software license.

If you have a subscription, you can install new, improved versions of the software as long as the subscription is valid.

For information on Hardware Extended Warranties or Software Maintenance, contact your Spectra Geospatial distributor.

### Solution Improvement Program

The Spectra Geospatial Solution Improvement Program collects information about how you use Spectra Geospatial programs and about some of the problems you may encounter. Spectra Geospatial

uses this information to improve the products and features you use most often, to help you to solve problems, and to better meet your needs.

Participation in the program is strictly voluntary. If you participate, the Origin log file is automatically sent to the Spectra Geospatial server each time you start the Origin software. The file includes data on what the Spectra Geospatial equipment is being used for, what software functions are popular in specific geographical regions, and how often problems occur in Spectra Geospatial products that Spectra Geospatial can correct.

At any time, you can choose to participate, or not to participate in the Solution Improvement Program. To do this, in Origin tap  and select **About**. Tap **Legal** and select **Solution Improvement Program**. Select or clear the **I would like to participate in the Solution Improvement Program** check box.

For more information, go to [http://www.spectrageospatial.com/solution\\_improvement\\_program.aspx](http://www.spectrageospatial.com/solution_improvement_program.aspx).

### End User License Agreement (EULA)

To view the Origin software End User License Agreement (EULA), tap  and select **About**. Tap **Legal** and select **EULA**.

### To set the date and time

Origin uses the data and time setting on the controller for recording when changes are made to files.

To set the time and date on the controller:

1. Navigate to the operating system settings screen and search for **[Date & time]**.
2. Change the date and time as required.

To configure the GPS time display setting for the job:

1. Tap  and select **Job** to view the **Jobs** screen.
2. Select the job and tap **Properties**.
3. Tap **Units**.
4. In the **Time format** field, select the required time display format.

A time stamp is stored with every record in the job and output to the DC file every 30 minutes.

### To change language or terminology

#### To change the language of the software

1. Use Spectra Geospatial Installation Manager to install the required language pack to the controller.

2. Tap  and select **Settings / Languages**.
3. Choose the required language from the list.

The list of available languages is determined by the language files you chose to install with the software.

4. Restart the software.

To change the terminology used in the software

Select the **Use railroad terminology** option to use the following railway-specific terms if you are surveying a railway:

- **Slew** for **Go** when measuring your position relative to a string or when staking a station on a string.
- **Lift** for **V.Distance**

Select the **Use chainage distance terminology** option to use the term **Chainage** instead of **Station** for the distance along the road.

To use function keys on a tablet that has programmable keys

Select the **Use function keys** check box to be able to assign Origin software functions to a function key on a tablet that does not have dedicated function keys, such as the Spectra Geospatial ST10 tablet.

The Spectra Geospatial ST10 tablet does not have dedicated function keys but you can use the Button Manager app installed on the tablet to set any of the three programmable buttons on the front of the tablet as function keys. For more information, refer to the *Spectra Geospatial ST10 Tablet User Guide*. If you are using a third-party tablet, check your tablet documentation for information on supported function keys and whether they are programmable.

For more information, see [Favorite screens and functions](#).



## To enable the on-screen keyboard

If the controller is a Windows device and does not have a keypad, you must enable the Spectra Geospatial keyboard so that the on-screen keyboard automatically appears when you need to enter data in a field in the software.

**NOTE** - *If the controller is an Android device, there is no Spectra Geospatial keyboard setting. The Spectra Geospatial keyboard is always used instead of the operating system keyboard.*

To enable the Spectra Geospatial on-screen keyboard on a Windows device:

1. In Origin, tap  and select **Settings / Language**.
2. Select the **Use Spectra Geospatial keyboard** check box.
3. From the Windows desktop, swipe in from the right to access the **Action center**. Ensure **Tablet mode** is **Off**.
4. On a Windows 10 tablet, go to **Windows Settings**, tap **Devices / Typing** and turn off the **Show the touch keyboard when not in tablet mode and there's no keyboard attached** setting.

**NOTE** - *To access the Windows keyboard when using other Windows applications, tap the keyboard icon in the task bar or re-enable Tablet mode.*

**TIP** - If you do not need the on-screen keyboard, for example if the controller is connected to an external keyboard, clear the **Use Spectra Geospatial keyboard** check box.

## To turn sounds on and off

Sound events are prerecorded messages that notify you of an event or action that has occurred. They correspond with status line messages, and common error and warning messages.

To turn all sound events on or off:

1. Tap  and select **Settings / Languages**.
2. Select the **Play sound events** check box to turn on sound events, or clear it to turn them off.
3. Select the **Vibrate** check box to enable vibration feedback whenever Origin auto stores a point or when a point is ready to be stored.

This check box is available only when the controller is a Ranger 7 or a MobileMapper 60.



Sound events are stored as .wav files. You can customize your own sound events by replacing or deleting the existing .wav files located in the **Sounds** folder on the controller. The location of the folder depends on the controller operating system:

- On a Windows device: **C:\Program Files\Spectra Geospatial\General Survey\Languages\<language>\Sounds**
- On an Android device: **<Device name>\Spectra Geospatial Data\Languages\<language>\Sounds**

## To sign in

You must sign in using your **Trimble ID** to be able to:

- Work with data in the cloud.
- Use Origin and any Origin apps for which you have a subscription.

The Trimble Connect  icon in the title bar of the **Projects** screen or the **Jobs** screen is grayed out  if you are not signed in. Tap the  icon to sign in.

**NOTE** – *To sign in, you must be connected to the Internet.*

## To sign in

1. To view the **Sign in using Trimble ID** screen, tap the  icon in the **Projects** or **Jobs** screen.

**TIP** – If the controller has only Origin subscription apps installed and no licenses, the **Sign in using Trimble ID** screen appears the first time you start the software, and does not reappear on software start up unless you have previously signed out.

2. If you are the only person who uses Origin on the controller and you regularly use cloud projects or jobs, select the **Remember me** check box so that you are already signed in when you start Origin.

**TIP** – If you are signing in to use your Origin subscription, the subscription is locked to the controller until you sign out. In that situation, the **Remember me** check box has no effect.

3. Tap **Sign in using Trimble ID**. The **Trimble Identity** page opens in your browser.

**NOTE** – If you do not have a Trimble ID, tap **Create an account** to create one. Alternatively, tap **Sign in with Google** to sign in with an existing Google account, or click **Sign in with Apple** to sign in with an existing Apple account.

To sign in with an existing Trimble ID:

- a. Enter your username.

Your username is the email address you used when you set up your Trimble ID.

- b. Tap **Next**.

- c. Enter your password.

To see the characters you are entering into the **Password** field, tap .

If you have forgotten your password, tap **Forgot password?**

- d. If you have enabled **Multi-Factor Authentication** for your Trimble Identity account, you are prompted to enter the verification code that you have chosen to receive via SMS or via an authentication app such as Google Authenticator.

- e. The authentication successful message appears in your browser. You can close the browser tab and return to the Origin software.

4. The Origin software shows you are signed in. Tap the **Back** arrow to return to the previous screen.

The software displays the **Projects** screen or the **Jobs** screen, if you signed in from there. The colored Trimble Connect icon  in the title bar indicates you are signed in.



If you are using Origin subscription apps and signed in at software startup, the software displays the **About** screen, showing the subscriptions you have on the controller. Tap **Accept** to continue to the **Projects** screen.

**NOTE** – To comply with Chinese data regulations concerning the upload of Chinese geospatial data to servers outside of China, Origin prevents sign in to the Trimble Connect cloud platform if your IP address is determined to be in China.

## To sign out

To use Origin apps for which you have a subscription, you must sign in using your Trimble ID. Subscriptions are locked to the controller until you sign out. To use your Origin subscriptions on a different controller, you must **sign out** on the current controller.

To sign out, do one of the following:

- Tap the Trimble Connect icon  in the title bar of the **Projects** screen and then tap **Sign out**.
- Tap  and select **About** and then tap **Sign out**.

## If you cannot sign in to use your subscription

Occasionally you may not be able to sign in to use your Origin subscription. This can happen if your subscription has lapsed, or if your subscription is locked to another controller.

If you cannot sign in then the software shows the serial number of the controller that is using the subscription, and warns that the software will run in limited mode. Tap **Continue** to use the software in limited mode.

In limited mode you can use the software to upload/download data from the cloud, open jobs and review them, and export data.

**NOTE** – *In limited mode you cannot open Origin apps such as Roads or Pipelines, and you cannot connect the software to an instrument or a GNSS receiver.*

## The Origin workspace

This topic provides some tips on finding your way around the Origin workspace and interacting with the software.



### Working from the map

Once you have opened a project and job, the Origin workspace is centered around the map. To start work, select an item from the menu or tap and hold in the map and select the required action. The actions shown in the [map tap and hold menu](#) depend on the number and type of items already selected in the map.

Selecting a menu item or action opens a new screen that appears over the map, or a form that appears alongside the map.

### Softkeys

Softkeys at the bottom of the screen show actions and items relevant to the open screen or form.

Occasionally in landscape mode, and more commonly in portrait mode, the  icon appears in the softkey row to indicate there are more softkeys available. To view more softkeys, tap  or swipe right to left (or left to right) along the row of softkeys.

## Menu navigation

In most software screens you can tap ☰ to view the menu. From the menu, select:

- **Project** to view the **Projects** screen.
- **Job** to view the **Jobs** screen.
- **Favorites** to view shortcuts to your favorite screens. From this screen you can also return to screens that are already open in the software, shown in the **Return to** list. In landscape mode, the menu always opens with the **Favorites** item selected, and the **Favorites** list is shown alongside the menu. For more information, see [Favorite screens and functions, page 24](#).

The **Favorites** menu item is available only when a job is open.

- **Job data** to access the **Job data** menu and open the **Review job**, **Point manager** or other job data screens.

The **Job data** menu item is available only when a job is open.

- **General Survey** to switch to a different application if you have more than one Origin app installed.

When a job is open, the items that appear below the application name provide access to the menus within that app.

- **Instrument** to access the **Instrument** or **Receiver** menu.
- **Settings** to configure settings and survey styles.
- **Help** to view the installed help files.
- **About** to view information about the software.
- **Exit** to exit the software.

**TIP** – Swipe up in the menu to view all items. To use the controller keypad to select a menu item, press the key corresponding to the first letter of the menu item, for example press **H** to open the help, or press **I** to view the **Instrument** menu. You can use the keypad to navigate any menu in this way.

## Interacting with the software

The Origin UI operates in a similar way to the smartphone and tablet applications you already use. Use gestures to zoom and pan on the map. To scroll through a menu or list, simply swipe up. Where

you might be viewing a large amount of data, for example in the **Review job** or **Point manager** screens, the software provides more traditional scroll bars which you can tap and drag to move up and down the screen.

### Tap and hold options for copying and pasting text

When copying text from one field to another in Origin, you can cut, copy, or paste text using the **Text** tap and hold menu:

- To select text, tap and hold on the word to select, or tap and drag across the field to select more text. The **Text** menu appears.
- To select all of the text in the field, double-tap in the field, or tap and hold on a word and then tap **Select All** in the **Text** menu.
- To cut or copy the selected text, tap **Cut** or **Copy** in the **Text** menu.
- To paste text into an empty field, or to paste at the end of a field, tap and hold in the field and tap **Paste**.

To paste text within existing text in the field, tap the insertion point in the text and tap **Paste**.

On Windows controllers you can also use **Ctrl** key combination shortcuts to select all **Ctrl + A**, cut **Ctrl + X**, copy **Ctrl + C**, and paste **Ctrl + V** text.

### Status bar shortcuts

Tap items on the status bar to quickly navigate to the **Instrument functions** or **Receiver functions** screen and change settings or enable/disable functions. For more information, see [Status bar, page 32](#).

### Screen orientation



#### Landscape mode

The FOCUS 50 always operates in **Landscape mode**.

If the controller is a **Windows device**, Origin is designed to be used in **Landscape mode** but will rotate to Portrait mode if the controller is rotated and does not have a keypad.

In landscape mode, when a form is open alongside the map:

- To view more of the form, tap **≡** and swipe left. The form will resize to the closest preset position.

- To make any from full-screen, tap  and swipe across to the very left of the screen.
- To decrease the size of a form and view more of the map, tap  and swipe right.



To lock the device orientation, do one of the following:

- From the Windows desktop, swipe in from the right to access the **Action center**. Tap **Rotation lock** to enable it. The **Rotation lock** tile changes to blue.
- Press the Windows  + **O** keys on the controller keypad.

### Portrait mode

On the MobileMapper 60 handheld, Origin is designed to be used in **Portrait mode** or in **Landscape mode**.

In portrait mode:

- When a form is open alongside the map, tap  and swipe down to view more of the form, or tap  and swipe up to view more of the map.
- To view more softkeys, tap  or swipe right to left (or left to right) along the row of softkeys.
- There is no **Esc** softkey when Origin is running in portrait mode. To exit a screen without saving any changes, press the Back key on the device.

To lock the device orientation, do one of the following:



- From the Android Home screen, swipe up from the bottom of the screen and tap **Settings**. Select **Display / Advanced / Device** rotation and then select **Stay in Portrait view**.
- Swipe down twice from the top of the screen to view the Android status bar and then tap the **Auto-rotate** icon.

### Tips for Windows devices

On the Ranger 7, the Origin software always runs in full screen mode, that is without showing the Windows title bar or task bar.

On other controllers, the software runs in full screen mode if the device is in Tablet mode. Spectra Geospatial recommends **turning off** Tablet mode in the Windows operating system, because the operating system and virtual keyboard are more accessible when Tablet mode is turned off.

If the controller has a physical keypad, or if you have connected an external keyboard, you can use the appropriate key-press combination to quickly access a different software program or to configure Windows system settings when you are in the Origin software:

- Press the **Windows** key  on the keypad to view the Windows **Start** menu and taskbar.
- Press the **Windows** key  + **D** keys on the keypad to view the Windows desktop.
- Press **Ctrl + Q** to exit Origin.

For other useful shortcuts, see [Keypad shortcuts, page 28](#).

### Tips for Android devices

When running Origin on an Android device:

- Spectra Geospatial Installation Manager for Android must remain installed on the controller for the Origin software to run.
- You can use a USB cable to transfer files between the controller and a Windows computer. See [File transfer, page 50](#).
- The controller can connect to all supported GNSS receivers and most conventional instruments using Bluetooth.

**NOTE** – *To perform a robotic survey when Origin is running on the MobileMapper 60 handheld, you will need to connect the MobileMapper 60 to the SPDL Radio Bridge or EDB10 Data Bridge.*

- The Origin software offers the same features as when running on a Windows device, except for the following:
  - BIM models and IFC files are not supported.
  - 12D Model .12da files are not supported.
  - The map **Limit box** is not supported.
  - The **GNSS emulator** and **Simulate controller** functions are not supported. For this reason, the **About** screen does not include the **Support** softkey.
  - The Android operating system does not support an Internet network connection to an external modem or cellular phone that requires Bluetooth DUN (dial-up networking). Instead, create network connections using Wi-Fi or the internal cellular modem.

### Favorite screens and functions

**Favorites** and **Functions** enable you to create shortcuts to software screens, map controls, or to enable/disable an instrument or receiver function.



To view Favorites, tap . The **Favorites** list is shown next to the menu. Tap a **Favorite** in the **Favorites** list to go straight to that screen or to enable/disable that instrument/receiver function.

The **Return to** list next to the **Favorites** list shows previously viewed screens that are still open. Tap an item to return to that screen.

**NOTE** - *To view Favorites when Origin is running in portrait mode, tap  and then select **Favorites**. The main menu changes to the **Favorites** menu, showing the **Favorites** list and the **Return to** list.*

If the controller has a numeric keypad, you can use the keypad to enter the keypad character (**1-9, 0, -** or **.**) indicated on the first twelve tiles to enable/disable the **Favorite** function or open the appropriate screen.

You can add your own items to the **Favorites** list and/or you can assign them to a function key on the controller. For example, if you assign the DR function to the **F3** function key on the controller, during a conventional survey press **F3** to enable/disable DR mode when viewing any screen in the software.

**NOTE** - *If you are using a tablet that has programmable buttons instead of dedicated function keys, such as the Spectra Geospatial ST10 tablet, then you must enable the **Use function keys** check box in the **Select language** screen. Use the Button Manager app installed on the ST10 to set any of the three programmable buttons on the front of the tablet as function keys. For more information, refer to the Spectra Geospatial ST10 Tablet User Guide. If you are using a third-party tablet, check your tablet documentation for information on supported function keys and whether they are programmable.*

### Grouping Favorites

You can create groups of favorites and functions and then use the group that matches your workflow. For example you might use one group when using a conventional instrument and another group when using a GNSS receiver. When using groups the function that is enabled when you press **F3** for example, depends on whether you are using the conventional instrument or GNSS group of functions.

Tap  next to the group name and select the required **Auto-switch** option to have the software automatically switch to that Favorites group when you start a conventional or GNSS survey. The **Auto-switch** function works best when you have set up a conventional group and a GNSS group of Favorites. The software will also auto-switch groups when the active instrument changes during an integrated survey.

### To favorite the current software function

To add a shortcut to a screen you use often or an instrument function you frequently enable and disable, tap ☆ to quickly add it to the Favorites list or assign it to a function key on the controller.

1. To add a shortcut to a:
  - software screen, navigate to the screen you want to add.
  - instrument/receiver function, tap the instrument/receiver icon in the status bar to view the **Instrument functions** or **GNSS functions** screen.
2. Tap ☆ next to the screen name or the instrument function name and then select whether to add the item to:
  - the **Favorites** screen
  - a function key
  - both the **Favorites** screen and a function key
3. If you are assigning the item to a function key, tap the appropriate function key in the **Select key to assign function to** screen. Tap **OK**.

A yellow star next to the screen name or function name in the **Instrument functions** or **GNSS functions** screen indicates this item is a favorite.

A function key name (for example **F3**) next to the screen name or function name indicates the keypad shortcut for this item.

**TIP** – If you have set up groups of Favorites, shortcuts are always added to the currently selected group. To change the group, tap ≡ and select the group from the drop-down list at the top of the **Favorites** list. You can copy or move shortcuts between groups if required.

### To manage your assigned function keys

To change the shortcuts that are assigned to the controller function keys, or to assign a function key to a software function for which there is no ☆ icon:

1. Tap ≡ and then tap ✎ next to **Favorites**. The **Edit** screen appears.
2. Select the **Function keys** option.
3. To assign a shortcut to a different function key, select an item and tap the left or right arrow to move the item.

4. To assign a function key to a software function for which there is no ☆ icon, tap + on the function key you want to use and select the function you want to assign. Tap **Accept**.
5. To remove a shortcut from a function key, select the item and tap **Delete**. Alternatively, tap **Delete All**.
6. Tap **OK**.



#### To create a Favorites group

1. Tap ≡ and then tap ✎ next to **Favorites**. The **Edit** screen appears.
2. With either the **Favorites** or the **Function keys** option selected, tap **New group**.
3. Enter the name for the group and tap **Enter**.  
The new group appears in the **Edit** screen.
4. Add and manage items in the group. To copy items or move items from a different group to the new group, tap and hold an item in a different group and select **Copy to** or **Move to** and then select the group.
5. To set up function key shortcuts for the group, select the **Function keys** option at the top of the screen. To copy items or move items from a different group to the new group, tap and hold an item in a different group and select **Copy to** or **Move to** and then select the group.
6. Tap **Accept**.  
The **Favorites** list shows items in the currently selected group. By default this is the group selected in the **Edit Favorites** screen when you tap **Accept**.
7. To use a different Favorites group, tap ≡ and then select the group from the drop-down list at the top of the **Favorites** list.

#### To manage the items in your Favorites list

1. Tap ≡ and then tap ✎ next to **Favorites**. The **Edit** screen appears.
2. Make sure the **Favorites** option is selected.

### 3. Make your changes:

- To rearrange items in the selected Favorites group, select an item and tap the left or right arrow to move the item.
- To remove items in the selected Favorites group, select the item and tap **Delete**.
- To have the software automatically switch to the Favorites group when you start a conventional or GNSS survey, tap  and select the required **Auto-switch** option.
- To replace the current shortcuts with the favorite shortcuts that are provided by default with the software, tap  next to the Favorites group name and then select **Defaults**.

If the software warns all the current favorite shortcuts will be deleted and replaced with the default ones, tap **Yes**.

- To delete a Favorites group, make sure the **Favorites** option is selected. Tap  and select **Delete group**. To delete all **Favorites** and groups, tap the **Delete All** softkey.

### 4. Tap **OK**.





## Keypad shortcuts

You can assign your own **custom shortcuts** to function keys on the controller. See [Favorite screens and functions, page 24](#).

If your controller has an alphanumeric keypad, or if you have connected an external keyboard, you can access frequently used functions by pressing the appropriate key combination.

### Keypad shortcuts for navigating the software



To...	Press...
Display the menu	<b>Menu</b> key (short press)
Display <b>Favorites</b>	The menu appears with the <b>Favorites</b> screen open. Use the right or down arrow keys to select a <b>Favorite</b> item. To close <b>Favorites</b> press the left arrow key and then use the up or down arrow keys to select a different menu item.
Display <b>Return to</b>	

To...	Press...
Display Instrument functions or GNSS functions screen	<b>Menu</b> key (long press) The <b>Instrument functions</b> screen appears if the software is connected to a conventional instrument. The <b>GNSS functions</b> screen appears if the software is connected to a GNSS receiver or is not connected to a receiver or instrument.
Display the target/prism selection screen	<b>Ctrl + P</b>
Show or hide the GNSS eBubble	<b>Ctrl + L</b> when connected to a GNSS receiver that supports the eBubble.
Display the fullscreen map	<b>Ctrl + M</b>
Display the <b>Review job</b> screen	<b>Ctrl + R</b>
Display the <b>Key in a note</b> screen	<b>Ctrl + N</b> To access the feature code library when keying in a note, press the <b>Space</b> key twice.
Navigate between open screens in the software	<b>Ctrl + Tab</b> to move between open screens (excluding the map) in one direction, or <b>Ctrl + Shift + Tab</b> to move open screens in reverse order. Open screens are listed in the <b>Return to</b> list in the <b>Favorites</b> screen.
Switch between plan and cross section view	Tap  or  , or press the <b>Tab</b> key. <b>TIP</b> – The plan and cross section views are available when staking an alignment or when surveying or reviewing a road using the Roads app.
Display the Windows <b>Start</b> menu	<b>Windows</b> key 
Display the Windows desktop	<b>Windows</b> key  + <b>D</b>
Lock the device orientation	<b>Windows</b> key  + <b>O</b>

## Keypad shortcuts for moving around a screen or selecting items

To...	Press...
Sort columns	Tap the column heading. Tap the column heading again to reverse the sort order.
Softkeys	<b>Ctrl + 1, 2, 3, or 4.</b> Press the number that corresponds to the position of the softkey (1 through 4, left to right).
Move between fields or items in a list	Up arrow, down arrow, <b>Tab</b> , <b>Back Tab</b> <b>TIP</b> – In the <b>Measure codes</b> form or the <b>Edit Measure codes</b> screen, press <b>Tab</b> to move between the different controls in the form. When the focus is on the code buttons, use the arrow keys to move to the next code button.
Open a dropdown list	Right arrow
Select items in dropdown lists	Press the first character of the list item. If multiple items start with the same character, press the first character again to move through the list.
Select a check box or button	<b>Space</b> (short press)
Delete a job or project	<b>Ctrl + Del</b>
To select multiple items in the map or in <b>Point manager</b>	Press and hold <b>Ctrl</b> and then tap the items.
To select a range of items in <b>Point manager</b>	Press and hold <b>Shift</b> and then tap the items at the start and end of your selection.

### Keypad shortcuts to perform functions

To...	Press
Enable/disable a <b>Favorite</b> function or open the appropriate screen	<p>Press the configured function key on the controller when viewing any screen in the software.</p> <p>Alternatively, tap  and press the numeric key on the controller keyboard corresponding to the button for the favorite (<b>1-9, 0, -</b> or <b>.</b>) to enable/disable the function or open the appropriate screen.</p>
Select an item in the <b>Instrument functions</b> screen	<p>Press the numeric key on the controller keyboard corresponding to the button for the favorite (<b>1-9, 0, -</b> or <b>.</b>) to enable/disable the function or open the appropriate screen.</p> <p>If you have configured a function key on the controller as a shortcut to an instrument function, you can press the configured function key when viewing any screen in the software.</p>
Select an item in the <b>GNSS functions</b> screen	<p>Press the numeric key on the controller keyboard corresponding to the button for the favorite (<b>1-9, 0, -</b> or <b>.</b>) to enable/disable the function or open the appropriate screen.</p> <p>If you have configured a function key on the controller as a shortcut to a GNSS function, you can press the configured function key when viewing any screen in the software.</p>
Switch between a GNSS and a conventional survey	Tap in the status line area of the status bar.
Measure a check shot	<b>Ctrl + K</b>
Initiate a measurement from the <b>Measure codes</b> screen	<p>Press the numeric key on the controller keyboard corresponding to the button for the code.</p> <p>When the buttons are set to a 3 x 3 layout, keys <b>7, 8, 9</b>, activate the top row of buttons, keys <b>4, 5, 6</b> activate the middle row of buttons, keys <b>1, 2, 3</b> activate the bottom row of buttons.</p> <p>When the buttons are set to a 4 x 3 layout, keys <b>0, -</b> and <b>.</b> activate the bottom row of buttons.</p> <p><b>NOTE -</b> You cannot use alphanumeric key shortcuts if the <b>Multi-code</b> button  is enabled.</p>

To...	Press
Select a group of codes in the <b>Measure codes</b> screen	Press A to Z to move to group pages 1 to 26. Key A opens group 1, Key B opens group 2... and key Z opens group 26. <b>NOTE</b> – You cannot use alphanumeric key shortcuts if the <b>Multi-code</b> button  is enabled.
Compute a distance between two points	Enter the point names in the distance field, separated by a hyphen. For example, to compute the distance between points 2 and 3, enter "2-3". <b>NOTE</b> – This method works with most alphanumeric point names, but it does not support point names that already contain a hyphen.
Compute an azimuth from two points	Enter the point names in the <b>Azimuth</b> field, separated by a hyphen. For example, to compute the azimuth from point 2 to point 3, enter "2-3". <b>NOTE</b> – This method works with most alphanumeric point names, but it does not support point names that already contain a hyphen.
Select all	<b>Ctrl + A</b>
Cut	<b>Ctrl + X</b>
Copy	<b>Ctrl + C</b>
Paste	<b>Ctrl + V</b>
Save a screen capture of the current screen	On a Windows device: <ul style="list-style-type: none"> <li>Press <b>Windows + Fn + 0</b> to save the image as a file in the <b>Pictures\Screenshots</b> folder.</li> <li>Press <b>Fn + 0</b> to save the image to the clipboard.</li> </ul> On an Android device: Press <b>Power + Volume Down</b> to save the image as a file in the <b>Pictures\Screenshots</b> folder.
Close the software	<b>Ctrl + Q</b>
Simulate a controller	<b>Ctrl + Shift + S</b>

## Status bar

The status bar appears at the top of the screen when a job is open. It provides information about the equipment that is connected to the controller and access to commonly used functions.

### Conventional survey status bar







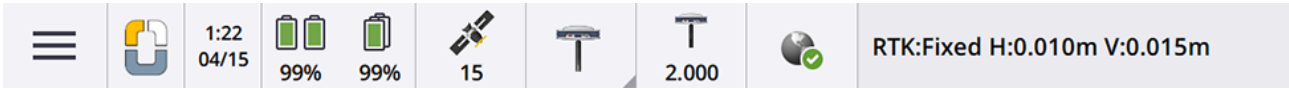

## GNSS survey status bar



### Common status bar items

Items that usually appear on the status bar are:

Item	Name	Description
	<b>Menu button</b>	Tap to view the menu.
	<b>Application icon</b>	Shows the current Origin app. If you have only one app installed, the status bar always shows the General Survey icon. To change to a different app, tap the icon and then select the app to switch to. <b>TIP -</b> In portrait mode, the app icon does not appear on the status bar. To change to a different tap, tap  and select the name of the current app (for example, <b>General Survey</b> ) and then in the <b>Choose application</b> screen, tap the name of the app to switch to.
	<b>Application icon</b>	Shows the current Origin app. If you have only one app installed, the status bar always shows the General Survey icon. If you have the Origin Roads app installed, then to swap between apps, tap the icon and then select the app to switch to. <b>TIP -</b> In portrait mode, the app icon does not appear on the status bar. To change to a different tap, tap  and select the name of the current app (for example, <b>General Survey</b> ) and then in the <b>Choose application</b> screen, tap the name of the app to switch to.
	<b>Date and time</b>	Shows the current date and time.

Item	Name	Description
	<b>Status line</b>	<p>The status line displays a message when an event or action occurs. Tap the status line to switch from one instrument to another during an <a href="#">integrated survey</a>.</p> <p>The status line appears at the far right of the status bar. In portrait mode it appears below the status bar.</p>

### Battery status

The **Battery status** area on the status bar shows the status of the battery in the controller and devices connected to the controller. If the controller has more than one battery, the power level of each battery is shown.

To view the **Battery status** screen, tap the battery status area of the status bar.

### Conventional survey status



During a conventional survey, values for the current horizontal angle or vertical angle and distance are shown in the status line.







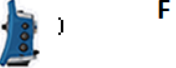

### Instrument status

To view the:

- [Instrument functions, page 322](#) screen, **tap** the Instrument icon in the status bar.
- [Instrument settings, page 334](#) screen, **tap and hold** the Instrument icon in the status bar.





The Instrument icon indicates the type of connected instrument. Symbols are added to the Instrument icon to indicate status.

Icon	Indicates
	The software is connected to a Spectra Geospatial FOCUS <sup>®</sup> 30 or 35 total station.
	The instrument is locked onto the target (prism).
	The instrument is locked and measuring to the target (prism).
	The instrument is in Fast Standard (FSTD) mode. It averages the angles while a fast standard measurement is taken.

Icon	Indicates
 <b>S</b>	The instrument is in Standard (STD) mode. It averages the angles while a standard distance measurement is taken.
 <b>*T</b>	The instrument is in Tracking (TRK) mode. It constantly measures distances and updates in the status line.
 <b>*T</b>	The instrument is locked to the target (prism) and receiving an EDM signal back from the prism.
	The laser pointer is on (DR mode only).
	The high power laser pointer is on.
	Radio signals from the robotic instrument are no longer being received.
	The compensator is disabled.
	Auto-connect is disabled. Tap the icon once to restart auto-connect. Tap the icon again to configure <a href="#">Auto-connect settings, page 437</a> .

### Target status



To change the target or target settings, tap the Target status icon in the status bar. See [Target height, page 315](#).

Icon	Indicates
 <b>+0</b> <b>1.500</b>	The prism is locked. "1" indicates that <b>target 1</b> is in use. The <b>prism constant</b> (in millimeters) and <b>target height</b> are shown to the right of the icon. When measuring a point with a dual-prism offset, two prism constants are shown.
 <b>+0</b> <b>0.000</b>	The instrument is in Direct Reflex mode.
	The rotating target icon indicates that the instrument has Autolock enabled but is not currently locked onto a target.
	GPS Search is enabled.

## GNSS survey status

During a GNSS survey, precision information for the current position is shown in the status line.

### Satellites

The number below the satellite icon  indicates the number of satellites in the solution if you have started a survey, or the number of satellites being tracked if you have not yet started a survey. To view the **Satellites** screen, tap .





**TIP** - If **[A]** or **[B]** appears next to the number of satellites in an RTK survey, then an independent subset of satellites is being used. See [To use independent subsets of satellites tracked in RTK surveys, page 404](#).

### GNSS receiver

To view the:





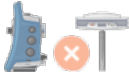









- [GNSS functions, page 400](#) screen, **tap** the GNSS receiver icon in the status bar.
- [Receiver settings, page 408](#) screen, **tap and hold** the GNSS receiver icon in the status bar.

The GNSS receiver icon indicates the type of connected GNSS receiver:

Icon	Indicates
	Spectra Geospatial SP60 receiver
	Spectra Geospatial SP80 receiver
	Spectra Geospatial SP85 receiver
	Spectra Geospatial SP90m receiver
	Auto-connect is disabled. Tap the icon once to restart auto-connect. Tap the icon again to configure <a href="#">Auto-connect settings, page 437</a> .

### Real-time correction information

To view more detailed status information, tap the real-time correction information area of the status bar.

Icon	What it shows
	Radio signals are being received.
	Radio signals are no longer being received.
	Cellular modem signals are being received.
	Cellular modem has hung up, or has stopped receiving corrections.
	SBAS signals are being received.
	RTX satellite signals are being received and an RTX position is being generated.
	Data is being received from the RTX satellite but an RTX position cannot be generated yet.
	An RTX survey is running but data is not being received from the RTX satellite.
	A point is being measured.
	Continuous points are being measured.
	A real-time survey is running and base data from a network connection is being streamed to the rover.
	Real-time base data streaming from a network connection is paused. Base data streaming automatically restarts when required.
	A real-time survey is running and base data from a network connection is being received but the solution from the receiver is not yet using that base data.
	A real-time survey with base data from a network connection is stopped. The base station network connection is maintained, but the real-time base data will not be streamed to the rover.
	A real-time survey is running but base data from a network connection cannot be received.

### Antenna details

The current antenna height is shown below the antenna icon. If the antenna icon is the same as the receiver icon then the internal antenna is being used.

To change the current antenna settings, tap the antenna icon in the status bar.

### Battery status

To view the **Battery status** screen, tap the battery status area in the status bar.

The **Battery status** screen shows the status of the battery in the controller and devices connected to the controller. If the controller has more than one battery, the power level of each battery is shown.

If the battery icon is  , then the battery level is close to 0%. If you have inserted a battery that has a higher level of charge then the battery may be in an unusual state and the power level cannot be determined. Remove the battery and reinsert it. If the issue is not resolved, recharge the battery and try again. If there are still issues, contact your Spectra Geospatial distributor.

If external power is being used, for example when the controller is connected to an external power source, the battery icon shows  .

To configure power save settings for the controller, tap the power level indicator for the controller battery.

To view instrument or receiver settings, tap the power level indicator for the instrument or receiver battery.

## Projects & jobs

A **project** is a folder for grouping Origin jobs and the files used by those jobs, including control points, road or alignment RXL files, background images or surfaces, and reference files for the project such as site or health and safety information.

A **job** contains the raw survey data from one or more surveys, and the configuration settings for the job including coordinate system, calibration, and measurement unit settings. Images captured during the survey are stored in separate files and linked to the job. A job may also contain control points if you have imported them into the job instead of using a linked file from the project folder.

To start a survey you must have at least one project and one job.

Projects and jobs can be local to the controller or they can reside on the Trimble Connect cloud collaboration platform, from which they can be downloaded to the controller. On the controller, jobs are stored in the appropriate project folder in the **Spectra Geospatial Data** folder. For more information on how files and folders are organized on the controller, see [Data folders, page 46](#).

When creating a job, you can save the settings as a template and then create subsequent jobs using the template. Jobs in the same project usually have the same settings but this is not essential.

### Project and job creation

Who creates the project and jobs and how they do this depends on your organization. The options are:

- **Projects and jobs** are created **in the office** using Sync Manager and sent to the cloud, from which they are downloaded to the controller. Project and job data on the controller can be uploaded to the cloud at any time.

If required, new jobs can be created locally on the controller and then uploaded to the cloud.

- **Projects** are created **in the office** using Sync Manager and sent to the cloud, from which they are downloaded to the controller. **Jobs** are created **locally** on the controller and uploaded to the cloud. Project and job data on the controller can be uploaded to the cloud at any time.
- **Projects and jobs** are created **locally** on the controller.



Local projects and jobs can be uploaded to the cloud later, as required.

## Working with cloud projects and jobs

### Creating projects and jobs in the office

Use Sync Manager to create projects and jobs using data from Survey Office, AutoCAD Civil 3D, 12d Model, Bentley civil software and other survey and civil engineering software. The software sends the projects and jobs to Trimble Connect. For more information refer to the [Sync Manager Help](#).

### Working on cloud projects and jobs on the controller





To work with projects and jobs that reside in the Trimble Connect cloud collaboration platform you must have a current Origin Software Maintenance agreement. To see projects and jobs from the cloud, the controller must be connected to the Internet and you must be [signed in using your Trimble ID](#). The Trimble Connect icon  in the title bar is grayed out  if you are not signed in. Tap the  icon to sign in.

When you are signed in, projects and jobs that reside in the Trimble Connect cloud collaboration platform and assigned to you are shown in the **Projects** and **Jobs** screens of the Origin software. You are also notified by email when a job is assigned to you from Trimble Connect.

### Downloading or uploading projects and jobs

You can download individual projects and jobs as required. During project download, the <project> folder is created on the controller and any project files are downloaded. Once you have downloaded a project, you can download jobs in the project.

The cloud icons next to the project or job name indicate if there are changes to be uploaded or downloaded:

-  indicates there are changes in the project or job in the cloud to be downloaded to the controller.
-  indicates there are changes in the project or job on the controller to be uploaded to the cloud.
-  indicates the project or job in the cloud is exactly the same as the project or job on the controller.
-  indicates there are changes in the cloud project or job that conflict with the local project or job and action is needed. See [Managing the synchronization of individual files, page 41](#).

When you change the status of a job to **In progress** or **Fieldwork complete**, changes to the job are automatically uploaded to the cloud, including local jobs in projects that reside in Trimble Connect.

You can upload data to the cloud at any time, by uploading changes in the job or by uploading changes to all jobs in the project at once. Select the project or job and then tap  and select **Upload**.

To include project files linked to jobs when uploading data, select the project in the **Projects** screen and then tap , select **Settings** and select the **Upload linked project files as well as field data and exports** check box. Clear the check box to only upload field data and data exported from the jobs.



**NOTE** – If a downloaded project shows a locked icon , it indicates you are assigned to the project but you cannot open it because you have not been assigned a Connect Business for Origin subscription. Users without a Connect Business for Origin subscription are able to work with only one project. To request a subscription, contact your project administrator.

**TIP** – If a cloud project is mysteriously duplicated on the controller (where the new project has a number appended to the project name), then the original project on the controller may have lost the ProjectInformation.xml file which creates the connection between the field and cloud projects. If this occurs we recommend you shut down Origin, use File Explorer to rename the two projects on the controller, and then start Origin and download the cloud project again. Use File Explorer again to copy any files from the renamed projects into the project just downloaded.

#### Managing the synchronization of individual files

When downloading data to the controller or uploading data to the cloud, you can choose to skip the transfer of individual files, if required. This is especially useful when you have large files that you do not want to transfer from the field. In the **Download** or **Upload** screen, tap file name and select **Skip this file**. The icon next to the file changes to  to indicate that action is needed for the file. You can download or upload the file later when you have returned to the office.

If the  icon appears next to the project or job it indicates there are changes in the cloud project or job that conflict with the local project or job and action is needed. Select the project or job and select **Upload** or **Download**. In the **Upload** or **Download** screen, the red icon indicates the file that is in conflict. Tap the file and then select one of the following:

- **Overwrite local file:** Changes made to the local file will be lost.
- **Keep local file:** Cloud file contents will be overwritten on the next upload.

Occasionally when downloading a project the software will not present the **Overwrite local file** or **Keep local file** options and instead shows a message warning that the file contains content from another project and the local file must be removed or renamed before the file can be downloaded. Tap **Esc** to return to the **Projects** list and then open File Explorer and navigate to the **C:\ProgramData\Spectra Geospatial Data** folder and remove or rename the appropriate file.

#### Working with local projects and jobs

##### Creating local projects

You can create local projects on the controller, as required. See [To create a local project, page 45](#).

You will need to manually transfer data files that you want to use to the project folder on the controller. See [File transfer, page 50](#) and [Data folders, page 46](#).

You can upload a project you have created on the controller to the cloud later, if required. See [To upload a local project to the cloud, page 46](#).

## Creating local jobs

You can create local jobs on the controller as required.

**TIP** – The process for creating a local job is the same, whether the job is part of a local project or a project that resides in the cloud. As long as a local job is in a cloud project you can upload the local job to the cloud at any time after you have created it. To do this, tap  in the details panel and select **Upload**.

You can create local jobs from:

- the last used job in the current project
- a template, including templates you have created from previous jobs
- a JobXML or DC file in one of these formats:
  - JobXML
  - SDR33 DC
  - Trimble DC v10.7
  - Trimble DC v10.0
  - SC Exchange

**NOTE** – *Importing from a JobXML file to a Origin job file is mainly used to transfer the coordinate system definition and design information. A JobXML file generated from a Origin job contains all the raw data in the FieldBook section, and "the best" coordinate for each point from the job in the Reductions section. Only the data from the Reductions section is read into the new Origin job file, raw observations are not imported.*

## Managing projects



The **Projects** screen appears each time you start the Origin software. To view the **Projects** screen at any time, tap  and select **Project**.

The **Projects** screen lists the projects in the **Projects** folder on the controller.

Tap a project to select it. The project details panel shows the names of jobs in the project, including jobs in any folders in the project.

**TIP** – To view the project details in portrait mode, tap  and select **Details**.

If you are signed in using your Trimble ID, projects that are shared with you but are not yet downloaded from Trimble Connect are shown in gray text.

**NOTE** – To download projects that reside in the Trimble Connect cloud collaboration platform or to upload changes to jobs in those projects, you must be [signed in using your Trimble ID](#). The Trimble Connect  icon in the title bar is grayed out  if you are not signed in. Tap the  icon to sign in.

#### To download a project

To download a project from the cloud:

1. Select the project. Projects that have not yet been downloaded to the controller are colored gray in the **Projects** list.
2. Tap **Download**.

The **Download** screen shows the name, type, and size of each file in the project that will be downloaded. The first time you download a project, Spectra Geospatial recommends you download all files. To manage the download of individual files or to deal with file conflicts, see [Managing the synchronization of individual files, page 41](#).

3. Tap **Download** to download the data to the controller.

**NOTE** – If a downloaded project shows a locked icon , it indicates you are assigned to the project but you cannot open it because you have not been assigned a Connect Business for Origin subscription. Users without a Connect Business for Origin subscription are able to work with only one project. To request a subscription, contact your project administrator.

#### To open a project

Tap a project to select it and tap **Open**.

When you open a project, the **Jobs** screen appears. See [Managing jobs, page 54](#).

#### To create a project

To create a new local project, tap **New**. See [To create a local project, page 45](#).

#### To upload a local project to the cloud

To upload a local project to the cloud, see [To upload a local project to the cloud, page 46](#).

#### To upload data to the cloud

To upload changes to **all** cloud jobs in the **project**, for example at the end of each day, select the project in the **Projects** screen and then tap  and select **Upload**. The **Upload** screen shows the name, type, and size of each file in the project that will be uploaded. Tap **Upload** to upload the data to the cloud.

**TIP** – To manage what is uploaded:

- To include project files linked to jobs when uploading data, select the project and then tap  , select **Settings** and select the **Upload linked project files as well as field data and exports** check box. Clear the check box to only upload field data and data exported from the jobs.
- To manage the upload of individual files or to deal with file conflicts, see [Managing the synchronization of individual files, page 41](#).

**NOTE** – If there are no **Upload** or **Download** options in the **Details** menu, the current project is a local project only and does not reside in the cloud. To upload a local project to the cloud, see [To upload a local project to the cloud, page 46](#).

When you change the status of a job that resides in the cloud to **In progress** or **Fieldwork complete**, changes to the job are automatically uploaded to the cloud.

To upload changes to a job that resides in the cloud at any time, select the job in the **Jobs** screen and then tap  and select **Upload**.

To find a project in the list

To search for part of the project name, enter the text to search for in the **Filter project** field. Project names that contain the entered letters are listed.

To show only projects on the controller, tap  and select **Controller**.

To show only projects in the cloud, tap  and select **Cloud**.

To refresh the list of projects, tap .

**TIP** – The projects screen checks for changes when you first open it but it does not refresh automatically. Tap  to see new projects, for example projects recently shared with you in Trimble Connect or if you have used File Explorer to create a new folder in the **Projects** folder.

To edit a project

To edit the project properties, tap **Properties**. Make your changes and tap **Accept**.

To delete or leave a project

You can delete local projects at any time. If a project resides in the cloud, you can choose to leave the project or delete it.

1. To delete a project, or to leave a cloud project, select the project in the list and then tap  and select **Delete**.
2. In the confirmation message that appears, select:

- **Delete from controller** to remove the project from the controller but stay assigned to the project.

The project remains in the projects list and is grayed out until you choose to download it again.

- **Delete from controller and leave cloud project** to leave the project in the cloud and delete the project from the controller.

To be able to download the project again you would need to be reassigned to it.

- **Delete from controller and the cloud** to remove the project from the controller and the cloud.

This option is only available if you are the only administrator for the project.

If the project resides in the cloud and you are not an administrator, you are not prompted to select an option. The message confirms that you will leave the project.

3. Tap **OK**.

**TIP** – You can leave a cloud project that you have not yet downloaded to the controller. You cannot delete projects that you have not yet downloaded because there is no data on the controller to delete.

### To create a local project

1. Tap  and select **Project**. The **Projects** screen is shown.
2. Tap **New**.
3. Enter the **Name** of the project.
4. If required, enter **Description**, **Reference**, and **Location** details.

This information will appear with the project name in the **Projects** screen.

5. If required, select an image for the project. To select a file on the controller or your network, tap .

The selected image will appear next to the project name in the **Projects** screen.

6. Tap **Create**.

The project folder is created on the controller and the **New job** screen appears.

**TIP** – You can upload projects you have created locally on the controller to the cloud, if required. See [To upload a local project to the cloud, page 46](#).

### To upload a local project to the cloud

Projects and jobs that reside in the cloud can be easily shared with other team members or managed from the office using Sync Manager.

To be able to upload a project to the cloud, the controller must be [connected to the Internet](#) and you must be [signed in using your Trimble ID](#). If you do not have a Trimble ID, you can create one from the **Sign in** screen. To view the **Sign in** screen, tap the  icon in the title bar of the **Projects** screen.

1. Select the project in the **Projects** screen and then tap  and select **Upload**.

The **Create cloud project** dialog appears.

2. Select the location of the Trimble Connect file server where the project will reside. Choosing the file server for the region closest to your location gives better performance when downloading or uploading data.

3. Tap **Yes**.

The **Upload project** screen shows the progress of the upload. Any project files that are uploaded are listed.

4. Tap **Accept**.

In the **Projects** screen, the cloud icon next to the project shows , which indicates the project in the cloud is the same as the project on the controller.

5. To upload any jobs in the project to the cloud, select the job in the **Jobs** screen and then tap  and select **Upload**.

**NOTE** – If jobs in the local project use a feature code library file, the feature code library file will need to be uploaded to the project in Sync Manager. For more information refer to the [Sync Manager Help](#).

### Data folders



All data used by the Origin software must be stored in the appropriate folder in the **Spectra Geospatial Data** folder.

The location of the folder depends on the controller operating system:

- On a Windows device: **C:\ProgramData\Spectra Geospatial Data**
- On an Android device: **<Device name>\Spectra Geospatial Data**

To view the **Spectra Geospatial Data** folder from the Origin software, tap  and select **Job data / File Explorer**.

**NOTE -**

- If you cannot see the **Spectra Geospatial Data** folder on an Android device, in **File Explorer** tap  and select **[Show internal storage]**. Then in **File Explorer** tap  and select the device name. The **Spectra Geospatial Data** folder appears in the list of folders on the device.
- To see the **System Files** folder on a Windows device, select **View** at the top of the **File Explorer** window and select the **Hidden items** check box.
- The **Projects** folder is created in the **Spectra Geospatial Data** folder the first time you run the Origin application.

**TIP -** To pin the **Spectra Geospatial Data** folder to your **Favorites** list in Windows Explorer, select **File explorer** from the **Job data** menu in Origin. In Windows Explorer, scroll up to the **Favorites** list at the top of the left pane. Right click **Favorites** and select **Add current location to Favorites**.

Project folders

Each project is stored in its own folder in the **Spectra Geospatial Data\Projects** folder.

Project files are stored in the appropriate **<project>** folder and can be used by any job in that project. Project files are typically map files, alignments, or control point files.

The following files are stored in the **<project>** folder:

File type	File extension
Job files	.job
JobXML files	.jxl
Comma Delimited (CSV) files	.csv
Comma Delimited (TXT) files	.txt
Digital Terrain Model files	.dtm
Triangulated Terrain Model files	.ttm
IFC (Industry Foundation Classes) files	.ifc

File type	File extension
TrimBIM (Trimble BIM files)	.trb
DXF (Drawing Exchange Format)	.dxf
ESRI Shapefiles	.shp
Georeferenced image files*	.tif, .bmp, .jpg, .png
RXL road or alignment files	.rxl
LandXML files	.xml
GENIO road files	.crd .inp .mos
12D Model files (Roads only)**	.12da

**NOTE -**

- *To be shown in the map in Origin, georeferenced image files must have an associated world file with the same name. Supported file extensions for world files include .wld, .tifw, .bpw, .jgw and .pgw. GeoTIFF files do not require a world file.*
- *JPG files must be in 24-bit color; pure grayscale JPG files are not supported.*
- *To use a .12da file, you must use the Origin Roads software to create a GENIO .mos file that contains models extracted from the .12da file.*

Htm reports (.htm) and comma delimited files (.csv) that are created when you export data using the **Export** function in the **Jobs** screen are also stored in the **<project>** folder.

**Job folders**

Each job is stored as a .job file in the appropriate **<project>** folder.

If required, you can store jobs in folders in the **<project>** folder. For Origin to be able to use the job, the combined length of the project folder name and folder names must not exceed 100 characters. The name of the job is not included in the 100-character limit.

To move a job to a different folder, use the **Copy job** function in Origin to copy the job and all linked files to the new folder and then delete the original job. See [To copy job files, page 59](#).

**NOTE -** *To avoid data synchronization issues, do not move jobs downloaded from Trimble Connect to a different folder.*

Each job has a **<job name> Files** folder which contains files such as image or GNSS data files that are created as work is done on the job.



The following files are stored in the **<job name> Files** folder:

File type	File extension	Subfolder
GNSS data	.t01, .t02, .t04	
Images	.jpg	
Original images	.jpg	<b>&lt;project&gt;\&lt;job name&gt; Files\Original Files</b>

Auto-generated folders are created as required, inside the **<job name> Files** folder:

- **<project>\<job name> Files\Original Files** is created when you [draw](#) on or annotate an image file. The original, unedited image is copied to the **Original Files** folder.

To easily copy jobs and associated files from one folder to another, or from one controller to another using an external drive such as a USB drive, tap **Copy** in the **Jobs** screen.

### System files folder

All system type files are stored in the **Spectra Geospatial Data\System Files** folder. System files are files that can be used by any project or job, such as survey styles, coordinate system files, and feature library files.

**NOTE** – *System files cannot be accessed if they reside in another folder.*

The following files must be stored in the **System Files** folder:

File type	File extension
Feature Library files (TBC)	.fxl
Survey Style files	.sty
Geoid Grid files	.ggf
Combined Datum Grid files	.cdg
Configuration	.cfg
Projection grid files	.pjg
Shift grid files	.sgf
UK National Grid files	.pgf
Broadcast RTCM transformation files	.rtd
Antenna files	.dat
GNSS Contacts file	.xml
Custom Import file definitions	.ixl

File type	File extension
XSLT Custom Export Stylesheet files	.xsl
XLST Custom Stakeout Stylesheet files	.sss
Measure Codes Database files	.mcd
Coordinate System Database files	.csd
Web map service configuration file	.wms

Web map service (.wms) files are created when a WMS is added in the **New web map service** screen. They can be copied between projects and controllers.

The **Cache** folder appears in the **System files** folder when IFC files are loaded in Origin. Caching IFC files on the controller enables faster reloading of IFC files.

**NOTE** - Stakeout stylesheet files (.sss) and Custom Export stylesheet files (.xsl) can be located in the language folder or **System Files**. Translated Stakeout stylesheet files and translated Custom Export stylesheet files are typically stored in the appropriate language folder.

#### Language, sound, and help files

Language files (.lng), sound files (.wav) and help files are stored in the appropriate language folder.

The location of the folder depends on the controller operating system:

- On a Windows device: **C:\Program Files\Spectra Geospatial\General Survey\Languages\<language>**
- On an Android device: **<Device name>\Spectra Geospatial Data\Languages\<language>**

#### File transfer

Origin supports the following methods transferring files between your controller and an office computer or network, or between controllers.

All data used by the Origin software must be stored in the appropriate folder in the **Spectra Geospatial Data** folder. See [Data folders](#).

#### Working with cloud data

Downloading data from and uploading data to the cloud is the simplest method of transferring data to and from the device. When you are signed in to Trimble Connect, projects and jobs that reside in the Trimble Connect cloud collaboration platform and assigned to you appear automatically in the **Projects** and **Jobs** screens of the Origin software. Use the Origin software to download projects and jobs to the controller and then upload changes to the cloud. See [Projects & jobs, page 39](#).

**NOTE** - To sign in to Trimble Connect, you must have [configured an Internet connection](#).

### Copying files from your organization's network

You can [configure an internet connection](#) to your organization's computer network and then log in to the network to view files and folders on the network. If you are transferring job files, you can use the **Copy** job function in Origin to transfer the job between the controller and a folder on the network. See [To copy job files, page 59](#). If you are transferring project files, use **File Explorer** to copy files to and from the controller. To open **File Explorer** from the Origin software, tap  and select **Job data / File Explorer**.

### Using a USB drive to transfer files

You can use a USB drive to transfer files from one computer to another. A USB drive, also called a flash drive or USB stick, plugs into the USB port of the controller. If you are transferring job files, you can use the **Copy** job function in Origin to transfer the job between the USB drive and the project folder. See [To copy job files, page 59](#). If you are transferring project files, use **File Explorer** to copy files to and from the USB drive. To open **File Explorer** from the Origin software, tap  and select **Job data / File Explorer**.



### Using a USB cable to transfer files (Android controllers only)

If the controller is an Android device, you can transfer files between the controller and a Windows computer.

1. To ensure the latest changes in the job are transferred, close the job in Origin. To do this, close the Origin software or open a different job.
2. To put the controller into **file sharing mode**:
  - If the controller is a FOCUS 50, use the Hirose-to-USB (PC) cable. The controller automatically enters file sharing mode when the cable is connected.
  - For any other Android controller, use a USB cable. To put the controller into file sharing mode, connect the cable and tap the **USB charging this device** notification on the Android device (you may need to swipe down from the notifications area at the top of the screen to see it). When you tap the notification, the **[Use USB to]** pop-up screen appears. Tap the **[Transfer files]** option.
3. To put the controller into file sharing mode, connect the cable and tap the **USB charging this device** notification on the Android device (you may need to swipe down from the notifications

area at the top of the screen to see it). When you tap the notification, the **[Use USB to]** pop-up screen appears. Tap the **[Transfer files]** option.

4. Once the controller is in file sharing mode, use **File Explorer** on the Windows computer to copy files to and from the controller.

If you cannot see the **Spectra Geospatial Data** folder, in **File Explorer** tap  and select **[Show internal storage]**. In **File Explorer** tap  and select the device name. The **Spectra Geospatial Data** folder appears in the list of folders on the device.

**TIP** – If the folders in the **Spectra Geospatial Data** folder do not appear as expected in **File Explorer**, restart the Android device.

### Multiple device setup

To streamline the process for setting up multiple controllers, you can modify some of the files in the **C:\ProgramData\Spectra Geospatial Data\System Files** folder in a text editor to meet your requirements and then copy those files to the other controllers.

**NOTE** – *Spectra Geospatial recommends saving any modified system files with a custom name. If you keep the original name, then the files will be replaced when you upgrade the controller and any custom changes are lost.*

### To set up default job properties

To streamline the process of creating a job, create a job and configure the job properties that you want to reuse and then save the job as a template.

To set default values for the **Reference**, **Description**, **Operator**, or **Notes** fields, or to set these fields as "required" so that values must be entered in these fields, edit the **JobDetails.scrpf** file in the **C:\ProgramData\Spectra Geospatial Data\System Files** folder. The settings in the **JobDetails.scrpf** file are read each time the Origin application is run. For more information on editing the file, refer to the notes provided at the top of the **JobDetails.scrpf** file.

To modify the list of descriptions used, edit the **descriptions.xml** file in the **C:\ProgramData\Spectra Geospatial Data\System Files** folder. the **descriptions.xml** file is created when you enter descriptions for points. The description stack is unique for each description field.

### To share groups of codes

To share groups of codes between controllers, create the code groups on one controller using the **Measure codes** screen. Code groups, and the codes within each group, are stored in a Measure Codes Database (MCD) file in the **C:\ProgramData\Spectra Geospatial Data\System Files** folder.

If you do not use a feature library, the software creates a **Default.mcd** file and this file is used whenever a job has no assigned feature library. Once you have set it up, you can copy the **Default.mcd** file to other controllers.

If you use a feature library, the MCD file is tied to that feature library and has a matching name. You can copy the MCD file to other controllers, but to use it in the software the associated feature library must also be on the controller and assigned to the job.

#### To lock a survey style

To prevent a survey style from being edited in the field, use File Explorer to navigate to the **C:\ProgramData\Spectra Geospatial Data\System Files** folder. Right-click the required survey style file and select **Properties**. In the **General** tab, select **Read-only** and tap **OK**.

In Origin, the lock symbol to the left of the style name indicates that you cannot edit this style.

**NOTE** - A locked style will be updated to reflect any changes made during the auto-connect cycle when connecting to an instrument.

#### To customize the coordinate system database

To customize the coordinate system database used by the Origin software, you must use the Coordinate System Manager software to modify the Coordinate System Database (CSD) and then transfer the modified database to the **System Files** folder on the controller. When a **custom.csd** file exists in the **C:\ProgramData\Spectra Geospatial Data\System Files** folder, the Origin software uses the **custom.csd** database instead of the coordinate system database built into the software.

For more information, see [To customize the coordinate system database, page 88](#).

#### To edit the list of GNSS contacts

You can create and edit profiles by editing the **GNSSContacts.xml** file that is stored in the **C:\ProgramData\Spectra Geospatial Data\System Files** folder.

You can also edit the **ServiceProviders.xml** file, so that it is easier to select the correct service provider when you configure a network connection using a mobile phone or Internet connection.

The **ServiceProviders.xml** file appears when you tap ► in the **APN** field of the **Network connection** screen and select the **Select Access Point Name** option.

#### To edit the list of antennas

The Origin software includes an **Antenna.ini** file that contains a list of antennas that you can choose from when creating a survey style. You cannot edit this list in the Origin software. To shorten the list or add a new antenna type, edit the **Antenna.ini** file in the **C:\Program Files (x86)\Common Files\Spectra Geospatial\Config** folder.

**NOTE** – When you transfer an *Antenna.ini* file, it overwrites any existing file of that name. The information in this file is also used in preference to the antenna information built into the Origin software.

### To edit the content and format of the delta display or reports

The content and format of the delta display that is shown during stakeout or when measuring a point relative to a 3D axis is controlled by XSLT style sheets. XSLT style sheets are also used to control the output and format of reports generated during export or to create custom import file formats. You can edit the existing style sheets or create new formats in the office and then copy them to the **C:\ProgramData\Spectra Geospatial Data\System Files** folder on the controller. For more information on editing style sheets, see [Custom import & export formats, page 70](#).

## Managing jobs



The **Jobs** screen appears each time you open a project or create a local project. To view the **Jobs** screen at any time, tap  and select **Job**.

The **Jobs** screen lists the jobs and folders in the current folder.

Tap a job to select it. The job details panel shows information about the job, including description, status, and linked files.

**TIP** – To view the job details in portrait mode, tap  and select **Details**.

If you are signed in using your Trimble ID, jobs and folders that contain jobs that are assigned to you but are not yet downloaded from Trimble Connect are shown in gray text.

**NOTE** – To download or upload jobs and job data, you must be [signed in using your Trimble ID](#). The Trimble Connect icon  in the title bar is grayed out  if you are not signed in. Tap the  icon to sign in.

This version of Origin can open jobs from version 2017.00 and later when running on a Windows device, and version 2019.00 and later when running on an Android device. When you open the job from the **Jobs** screen, Origin automatically converts the job to the current version of the software. For more information on loading jobs onto the controller, see [File transfer](#).

### To download a job

To download a job from the cloud:

1. If the project contains folders, tap a folder to view the jobs in the folder. Double-tap a folder to open it.

**TIP** – Tap  to move up a folder level. To view the folder structure, tap the folder path field above the job list.

2. Select the job and tap **Download**. Jobs and folders that have not yet been downloaded to the controller are colored gray in the **Jobs** list.

The **Download** screen shows the name, type, and size of each file in the job that will be downloaded. The first time you download a job, Spectra Geospatial recommends you download all files. To manage the download of individual files or to deal with file conflicts, see [Managing the synchronization of individual files, page 41](#).

3. Tap **Download** to download the data to the controller.

#### To open a job

Tap a job to select it then tap **Open**.

If the job you are opening has no defined project height, the **Project height** screen appears. Key in the project height, or tap **Here** to define the height using the current GNSS position. If there is no position available, the **Here** button is disabled.

When the job opens, the map appears. If no data appears in the map, or you cannot see the data you expect to see, tap  in the map toolbar to open the **Layer manager**. See [Layer manager, page 115](#).

#### To create a job

To create a new local job, tap **New**. See [To create a local job, page 56](#).

#### To find a job in the list

To refresh the list of jobs, tap .

**TIP** – The projects screen checks for changes when you first open it but it does not refresh automatically. Tap  to see new jobs, for example jobs recently shared with you in Trimble Connect or if you have used File Explorer to copy a job into the **Projects** folder.

To search for part of the job name, enter the text to search for in the **Filter job** field. Job names that contain the entered letters are listed.

To change the default filters, tap  and select the filter type. A check mark next to the filter means that filter is being applied. Select the item again to disable the filter.

To hide completed jobs from the **Jobs** screen, tap  above the job list and select **Status: Completed** so that there is no check mark next to it. The next time you change the status of a job to **Complete**, it will also disappear from the jobs list.

By default, only jobs in the cloud that are assigned to you (**Cloud: Assigned to me**) or were created by you (**Cloud: Created by me**), and any local jobs (**Controller**) are shown.

If your Sync Manager administrator has permitted, you may be able to see jobs that are not assigned to you. To do this, tap **▼** and select **Cloud**. Jobs that are not assigned to you but that you can download from Trimble Connect are shown in gray text. To download a job, select it and tap **Download**.

---

 **CAUTION** – If you download a job that is not assigned to you and then make changes to the job, you will not be able to upload your changes to the cloud.

---

#### To edit a job

To change the status of a job, tap the job to select it and in the details panel, select the new **Status** from the list. The status of a job can be **New**, **In progress** or **Fieldwork complete**.

To edit the job properties, tap **Properties**. Make your changes and tap **Accept**. See [Job properties, page 73](#).

To delete a job and all associated data files from the controller, tap **⋮** and select **Delete**. Tap **Yes** to confirm.

**TIP** – Files in the project folder are not affected when you delete a job. If the job resides in Trimble Connect, the job is only removed from the controller. Nothing is removed from Trimble Connect. You cannot delete jobs that you have not yet downloaded.

#### To upload data to the cloud

When you change the status of a job to **In progress** or **Fieldwork complete**, changes to the job are automatically uploaded to the cloud, including local jobs in projects that reside in Trimble Connect.

To upload changes to a job at any time, in the **job**, select the job in the **Jobs** screen and then tap **⋮** and select **Upload**. The **Upload** screen shows the name, type, and size of each file in the job that will be uploaded. Tap **Upload** to upload the data to the cloud. To manage the upload of individual files or to deal with file conflicts, see [Managing the synchronization of individual files, page 41](#).

To upload changes to **all** jobs in the **project**, for example at the end of each day, select the project in the **Projects** screen and then tap **⋮** and select **Upload**.

**TIP** – If there are no **Upload** or **Download** options in the **Details** menu, the job resides in a local project and data cannot be uploaded to the cloud.

#### To create a local job

When you create a new project, the **New Job** screen appears automatically.

To create a new job in an existing project, open the project from the **Projects** screen to view the **Jobs** screen. Tap **New**. The **New Job** screen appears.



**TIP** – To create a folder in the project folder for the new job, tap  in the **Jobs** screen or in the **New job** screen. Enter the **Folder name** and tap **Create**. The folder path is shown at the top of the **New job** screen.

In the **New job** screen:

1. To create a job from a template or the last used job:
  - a. Select the **Create from template** option.
  - b. Enter the **Job name**.
  - c. In the **Template** field, select:
    - **Default** to create the job from the default template provided with the software.
    - **<Template name>** if you have created a job template. See [Job templates, page 58](#).
    - **Last used job**.

All the job properties from the selected template or job are copied into the job.

The button next to each property field shows a summary of the current properties.

2. To create a job from a JobXML or DC file:
  - a. Select the **Create from JobXML or DC file** option.
  - b. Enter the **Job name**.
  - c. Select the **File format**.

**TIP** – If you are unsure of the file format, select any format and the software will check this when it imports the file.

- d. In the **From file** field, select the file. Tap  to navigate to a folder.
  - e. Tap **Accept**.
  - f. Tap **OK**.
3. To define or change the job properties, tap the appropriate button. Tap:
    - **Coord. sys.** to choose the coordinate system for the job. See [Coordinate system, page 73](#).
    - **Units** to select the units and formats for numerical values. See [Units, page 91](#).
    - **Layer manager** to link point files and map files to the job. See [Layer manager, page 115](#)

- **Feature library** to associate a feature library with the job. See [Feature library, page 95](#).
- **Cogo settings** to set the coordinate geometry settings for the job. See [Cogo settings, page 99](#).
- **Additional settings** to set additional settings for the job. See [Additional settings, page 108](#).
- **Media file** button to link media files to the job or to points in the job. See [Media files, page 110](#).
- If required, enter **Reference**, **Description** and **Operator** details, and any **Notes**.

**TIP** – To set default values for the **Reference**, **Description**, **Operator**, or **Notes** fields, use a text editor to modify the **JobDetails.scprf** file in the **C:\ProgramData\Spectra Geospatial Data\System Files** folder.

4. Tap **Accept**.

**TIP** – If you have created jobs locally on the controller and the project they are in resides in the cloud, you can upload the jobs to the cloud at any time. To do this, select the job in the **Jobs** screen and then tap  and select **Upload**. The **Upload** screen shows the name, type, and size of each file in the job that will be uploaded. Tap **Upload** to upload the data to the cloud.

### Job templates

A template makes it faster and easier to create jobs with the same settings. Create a template with the job properties configured as required and then create jobs from the template.

**NOTE** – *Templates are used only to import a set of job properties as you create the job. Editing or deleting a template has no effect on jobs previously created from the template.*

Tap  and select **Settings / Templates**. The **Templates** screen shows the default templates provided with the software and any templates you have created.

### To create a template

1. Tap **New**.
2. Enter the template name.
3. To create the template from another template or the last used job, select the template or **Last used job** in the **Copy from** field.

The properties from the selected template or job are copied into the job. Edit the properties as required.

4. Tap **Accept**.

### To Import a template from another job

1. Tap **Import**.
2. In the **Select job** screen, select the job. Tap **OK**.
3. Enter the **Template name**. Tap **Accept**.

The new template appears in the **Templates** screen.

### To edit the job properties configured in the template

1. To edit a template, select it and tap **Edit**.
2. To define or change the job properties, tap the appropriate button. Tap:
  - **Coord. sys.** to choose the coordinate system for the job. See [Coordinate system, page 73](#).
  - **Units** to select the units and formats for numerical values. See [Units, page 91](#).
  - **Layer manager** to link point files and map files to the job. See [Layer manager, page 115](#)
  - **Feature library** to associate a feature library with the job. See [Feature library, page 95](#).
  - **Cogo settings** to set the coordinate geometry settings for the job. See [Cogo settings, page 99](#).
  - **Additional settings** to set additional settings for the job. See [Additional settings, page 108](#).
  - **Media file** button to link media files to the job or to points in the job. See [Media files, page 110](#).
  - If required, enter **Reference**, **Description** and **Operator** details, and any **Notes**.

**TIP** – To set default values for the **Reference**, **Description**, **Operator**, or **Notes** fields, use a text editor to modify the **JobDetails.scprf** file in the **C:\ProgramData\Spectra Geospatial Data\System Files** folder.

### To copy job files

To copy jobs or to copy items between jobs, tap  and select **Job**, and then tap **Copy**. The **Copy** screen appears.

**TIP** – In portrait mode, swipe right to left along the row of softkeys to view the **Copy** softkey.

You can copy jobs into or out of the project folder or from one folder to another folder inside the project folder. All files associated with the job, including files that were collected during the survey (for example, image files) are copied at the same time.

The **Copy** function is especially useful when copying job files to a USB drive so that you can transfer jobs from one controller to another.

**NOTE** – *To avoid data synchronization issues, do not copy jobs downloaded from Trimble Connect to a different folder.*

### Copied items

When **copying job files**, you can choose to copy the following types of additional files:

- Coordinate system files
- Linked files
- Media files
- Feature library files
- Road files
- Exported files

**TIP** – To include design definition files used for road or alignment staking when copying job files, select the **Copy road files** or **Copy exported files** options.

**NOTE** – *Broadcast RTCM transformation (RTD) files associated with the job are not copied with the job. Users of RTD files should ensure the grid file on the controller that the data is being copied to contains grid data that covers the area of the copied job.*

When **copying items between jobs**, you can select from:

- Calibration
- All control points
- Calibration and control
- Local transformations
- Points
- RTX-RTK offset

### To copy a job to a different folder

Use these steps to copy jobs from one folder to another, for example on a USB drive.

1. In the **Copy** screen, select **Copy job files to**.
2. Browse to and select the **Job to copy**.
3. Tap  to select the **Destination folder** for the copied job.

You can select a folder on any available drive, such as a network drive or a USB drive.

If the controller is an Android device, you may be prompted to give Origin read and write permissions for the USB drive. When you tap **Yes**, the Android folder selection screen appears.

Tap  in that screen, browse to the USB drive and tap **[SELECT]**. The USB drive now appears in the Origin **Select folder** screen. If the **USB drive detected** message does not appear, or if you have dismissed the message, tap the **Select USB drive** softkey once the USB device is connected.

4. Select the folder for the copied job from the **Select folder** screen. Tap **Accept**.
5. To create a JobXML file, enable the **Create JobXML file** switch.
6. To copy project files associated with the job, select the appropriate check box(es).
7. Tap **Accept**.

### To copy a job into the current folder

Use these steps to copy a job from a folder into the current folder.

1. In the **Copy** screen, select **Copy job files from**.
2. Tap  to select the **Job to copy**.

The job can be in a folder on any available drive, such as a network drive or a USB drive.

If the controller is an Android device, you may be prompted to give Origin permission to use the USB drive. When you tap **Yes**, the Android folder selection screen appears. Tap  in that screen, browse to the USB drive and tap **[SELECT]**. The USB drive now appears in the Origin **Select folder** screen. If the USB permissions dialog does not appear, or if you have dismissed the dialog, tap the **Select USB drive** softkey once the USB device is connected.

3. Select the job to copy. Tap **Accept**.
4. To include all files starting with the same job name in the **<project>\Export** folder, select the **Include exported files** check box.
5. To copy project files associated with the job, select the appropriate check box(es).
6. Tap **Accept**.

#### To copy items between jobs

**NOTE** - You can only copy information between jobs that are in the current [project folder](#).

1. In the **Copy** screen, select **Copy between jobs**.
2. Tap  to select the **Job to copy**.
3. Select the job that the data will be copied to.
4. Select the type of data to be copied and select whether duplicate points should be copied. Duplicate points in the job you are copying to will be overwritten.

#### **NOTE** -

- *When copying points between jobs, make sure that the points you are copying use the same coordinate system as the job that the files are being brought into.*
- *When copying local transformations between jobs, all transformations are copied, and the copied transformations are not editable. To modify or update a copied transformation, update the original transformation and then copy it again.*

5. Tap **Accept**.

#### To import data to the job

1. Tap  and select **Job**.
2. In the **Jobs** screen, select the job to import data to.
3. Tap **Import**. The **Import** screen appears.
4. Select the **File format** of the file you are importing.

The options are CSV or TXT formats.

**TIP** – To create a job from a DC or JobXML file, see [To create a local job, page 56](#).

5. Tap  to browse to the file to import.

You can select a file on any available drive, such as a network drive or a USB drive.

If the controller is an Android device, you may be prompted to give Origin read and write permissions for the USB drive. When you tap **Yes**, the Android folder selection screen appears.

Tap  in that screen, browse to the USB drive and tap **[SELECT]**. The USB drive now appears in the Origin **Select folder** screen. If the **USB drive detected** message does not appear, or if you have dismissed the message, tap the **Select USB drive** softkey once the USB device is connected.

6. Select the file to import from the **Select a file** screen. Tap **Accept**.
7. To import points as control points, select the **Import points as control** check box.
8. If the selected file is a comma delimited CSV or TXT file:
  - a. Use the **Point name**, **Point code**, **Northing**, **Easting** and **Elevation** fields to map each field to the appropriate field in the file.
  - b. If the file contains null elevations, enter the **Null elevation** value.
  - c. In the **Duplicate point action** field, select the action the software should take if the file contains points of the same name as existing points in the job. Select:
    - **Overwrite** to store the imported points and delete all existing points of the same name.
    - **Ignore** to ignore the imported points of the same name so that they are not imported.
    - **Store another** to store the imported points and keep all existing points of the same name.
9. If the **Advanced geodetic** check box is enabled in the **Cogo settings** screen, and you select a CSV or TXT file, you must specify the **Coordinate type** of the points in the file. Select **Grid points** or **Grid (local) points**.
10. If the points in the file are **Grid (local) points**, select the transformation to use to transform them to grid points:

- To assign the transformation later, select **Not applied, this will be defined later**. Tap **Accept**.  
***NOTE** – If you select this option and you later decide to assign an input transformation to this file, you must unlink and then relink the file.*
- To create a new display transformation, select **Create new transformation**. Tap **Next** and complete the required steps. See [Transformations, page 261](#).
- To select an existing display transformation, select **Select transformation**. Select the display transformation from the list. Tap **Accept**.

11. Tap **Accept**.

12. Tap **OK**.

### To export data from the job

1. Tap  and select **Job**.
2. In the **Jobs** screen, select the job to import data to.
3. Tap **Export**. The **Export** screen appears.
4. In the **File format** field, select the type of file to create.

By default, the **File name** field shows the name of the current job and the file extension is the file extension for the selected file type.

5. If required, edit the file name.
6. Tap  to browse to the folder to export the file to. By default, files are exported to the most recently selected folder. If no folder was selected, files are exported to the **Export** folder in the same folder as the job.

You can select a folder on any available drive, such as a network drive or a USB drive.

If the controller is an Android device, you may be prompted to give Origin read and write permissions for the USB drive. When you tap **Yes**, the Android folder selection screen appears.

Tap  in that screen, browse to the USB drive and tap **[SELECT]**. The USB drive now appears in the Origin **Select folder** screen. If the **USB drive detected** message does not appear, or if you



have dismissed the message, tap the **Select USB drive** softkey once the USB device is connected.

7. Select the folder for the exported file from the **Select folder** screen. Tap **Accept**.

8. If the file format you selected is:

- **Comma Delimited (\*.CSV, \*.TXT)**, select a field for each value. When you tap **Accept**, you will be able to select the points to export. See [Selecting points](#).
- **DXF**, select the **DXF file format** and the item types to export.

If a point has features and attributes assigned to it then all the attributes are added as attributes of the inserted point in the DXF file.

When a feature library (\*.fxl) created by the Survey Office software's Feature Definition Manager is used, the layers and colors defined in the FXL are used in the DXF.

- **ESRI Shapefiles**, set the **Coordinates** to **Grid** (northing/easting/elevation) or **Lat/Long coordinates** (local latitude/longitude/height).
- **Grid local coordinates**, select whether to output the original entered grid (local) coordinates or the computed display grid (local) coordinates.

**NOTE** – *The computed grid (local) coordinates are derived by taking the keyed-in or computed grid coordinates and then applying the display transformation. You must set the required display transformation **before** you export the file. To do this in **Review job**, select a point, go to **Options**, set the **Coordinate view** to **Grid (local)** and then select a **Transformation for grid (local) display**.*

- **Stakeout report**, specify the acceptable stakeout tolerances in the **Stakeout horizontal tolerance** and the **Stakeout vertical tolerance** fields. Any stakeout delta greater than the defined tolerances appears in color in the generated report.
- **Surface inspection report**, enter a **Report description** that will appear near the top of the report.

**NOTE** – *The **Surface inspection report** is available only as a PDF file.*

- **Survey report**, select whether to generate a detailed report and the format for reporting GNSS deltas.
  - **Traverse report**, specify the traverse deltas limit. Values that exceed this limit are highlighted in the generated report.
  - **JobXML**, select the appropriate version number.
  - **Utility Survey DXF**, configure the options for creating lines and generating text.
9. To automatically view the file after you create it, select the **View created file** check box.
  10. If you selected the **Comma Delimited (\*.CSV, \*.TXT)** file format, the **Select points** screen appears. Choose the method for selecting the points and then select them. See [Selecting points](#).
  11. Tap **Accept**.

### Import and export file formats

Predefined import and export file formats are defined using XSLT style sheet (\*.xsl) definition files. They are typically located in the **Spectra Geospatial Data\System Files** folder.

The predefined style sheet definitions are provided in English. Translated stylesheet files are typically stored in the appropriate language folder.

The location of the folder depends on the controller operating system:

- On a Windows device: **C:\Program Files\Spectra Geospatial\General Survey\Languages\<language>**
- On an Android device: **<Device name>\Spectra Geospatial Data\Languages\<language>**

You can import and export data using the predefined file formats, or you can create your own formats.

### Import file formats

You can use the predefined formats or create a comma delimited CSV or TEXT file.

**TIP** – DC and JobXML files are not imported; instead create a job from these files. See [To create a local job, page 56](#).

## Predefined file formats

Select from the following predefined formats:

- CSV Grid points E-N

The data must be in the format Name, Easting, Northing, Elevation, Code

- CSV Grid points N-E

The data must be in the format Point Name, Northing, Easting, Elevation, Code

- CSV Lines

The data must be in the format Start Point Name, End Point Name, Start Station,

- CSV Global Lat-long points

- Surpac

**NOTE** – To be successfully imported, points in **Global** and local geographic coordinates must have a height.

## Comma delimited CSV or TXT files

If the Comma Delimited (\*.CSV, \*.TXT) option is selected, you can specify the format of the data that is received. Five fields appear: **Point name**, **Point code**, **Northing**, **Easting**, and **Elevation**. If [description fields](#) are enabled for the job, there are two additional fields to configure. Select **Unused** if a particular value is not present in the file being received.

When opening linked CSV files or importing any of the predefined CSV file formats, Origin automatically detects if the file is using UTF-8 character encoding. If UTF-8 is not detected, Origin assumes the data is using ASCII/Multibyte encoding.

**NOTE** – Where possible, Spectra Geospatial recommends standardizing on UTF-8 for your CSV files, because it can encode any character in Unicode. ASCII/Multibyte encoding is locale-specific and so may not encode all characters correctly.

## Null elevations

If the comma-delimited file you are importing contains 'null elevations' that are defined as something other than null, for example a 'dummy' elevation such as -99999, you can configure the format of the **Null elevation** and the Origin software converts these 'null elevations' to real null elevations inside the job.

The **Null elevation** value is also used when points are imported or copied from linked CSV files.

## Coordinate type and local transformations

If **Advanced geodetics** is enabled, then for most file formats you must specify the **Coordinate type** of the points in the file.

You can create a transformation when you import grid local points, but you cannot use the grid local points from the file you are about to import unless that file has already been linked to the current job.

## Export file formats

Data can be exported as machine-readable files for use in other software applications, or as human-readable reports in Word or HTML format.

Use these files to check data in the field, or to produce reports, which you can transfer from the field to your client or to the office for further processing with the office software.

## Predefined file formats

The predefined export file formats available on the controller include:

- Check shot report
- CSV Global Lat-long points
- CSV with attributes
- DXF
- ESRI Shapefiles
- GDM area
- GDM job
- Grid (local) coordinates
- ISO rounds report
- JobXML
- Locator to CSV
- Locator to Excel
- M5 coordinates
- Road-line-arc stakeout report
- SC Exchange

- SDR33 DC
- Stakeout report
- Surface inspection report
- Survey report
- Traverse adjustment report
- Traverse deltas report
- Trimble DC v10.0
- Trimble DC v10.7
- Utility Survey DXF
- Volume computation report

#### Comma delimited CSV or TXT files

If the Comma Delimited (\*.CSV, \*.TXT) option is selected, you can select the points to export and specify the format of the data that is received. Five fields appear: **Point name**, **Point code**, **Northing**, **Easting**, and **Elevation**. If [description fields](#) are enabled for the job, there are two additional fields to configure. Select **Unused** if a particular value is not present in the file being received.

When you tap **Accept**, you will be able to select the points to export. See [Selecting points](#).

#### Additional predefined formats available for download

The following predefined formats are available for download:

- CMM coordinates
- CMM elevations
- KOF
- SDMS

To download these formats, go to [Spectra Geospatial Origin Downloads page](#) and click **Style Sheets / General Survey Style Sheets** and then click the appropriate link to download a zip file. Copy the contents to the **C:\ProgramData\Spectra Geospatial Data\System Files** folder on the controller.

If you have measured depths using an echo sounder, you can also download the following custom report formats to generate reports with depths applied:

- **Comma Delimited with elevation and depths.xsl**
- **Comma Delimited with depth applied.xsl**

For more information, see [To generate reports that include depths.](#)

#### Custom import & export formats

You can modify a predefined format to meet your specific requirements, or use it as a template to create a completely new custom import or export format.

You can use any text editor, such as Microsoft Notepad, to make minor changes to the predefined formats.

Modifying a predefined format offers the following benefits:

- Important information can be displayed first.
- Data can be ordered to suit your requirements.
- Information that is not required can be removed.
- Additional data can be computed for display, for example by applying construction offsets to reported values.
- The point design elevation can be edited after the stake out measurement is completed.
- Up to 10 extra design elevations with individual vertical offset values can be defined and edited, with the cut/fill to each extra design elevation being reported.
- The size and color of the font can be modified to suit your requirements

**NOTE** – *Spectra Geospatial recommends saving any modified XSLT files with a new name. If you keep the original name, predefined XSLT files are replaced when you upgrade the controller, so any custom changes are lost.*

#### Creating a new custom format

To create a completely new custom format, you need some basic programming knowledge to modify the XSLT file. XSLT style sheet definition files are XML format files. Style sheets must be created according to the XSLT standards as defined by the World Wide Web Consortium (W3C). For details, go to [www.w3.org](http://www.w3.org).

You cannot easily modify or create a style sheet on the controller. To successfully develop new style sheet definitions, work on an office computer using a suitable XML file utility program.

Origin version 2021.00 and later supports stylesheets that use the following EXSLT modules:

- **math:** math functions typically defined to use the math: namespace
- **date:** date and time functions typically defined to use the math: namespace (except for date:format-date, date:parse-date and date:sum)
- **sets:** functions to provide set manipulation typically defined to use the set: namespace
- **strings:** functions to provide string manipulation typically defined to use the set: namespace
- **functions:** functions that allow users to define their own functions for use within XSLT (except for func:script)

For details on the use of these extension functions within style sheets, refer to the [exslt.org](http://exslt.org) web site which provides full details on the functions.

**NOTE** – *Style sheets using these EXSLT extensions can be used in Origin, but will not operate successfully in the File and Report Generator utility program, or in Sync Manager, as these systems are based on solely on the style sheet functionality available the Windows operating system.*

### Requirements

To develop your own XSLT style sheets, you need:

- An office computer.
- Basic programming skills.
- An XML file utility program with good debugging facilities.
- The JobXML file schema definition that provides the details of the JobXML format required to create a new XSLT style sheet. There is a link to the schema location at the top of every JobXML file.
- A job or JobXML file that contains the source data.

The predefined XSLT style sheets and the File and Report Generator utility are available for download. Go to [Spectra Geospatial Origin Downloads page](#), select the **Style Sheets** section and download the appropriate style sheet links. The predefined style sheet definitions are provided in English. Modify these files as required to your own language.

## Custom stylesheet creation process

The basic steps are:

1. Source a Job file or JobXML file from your controller.
2. Create the new format using a predefined XSLT style sheet as a starting point and the JobXML schema as a guide.
3. To create the new custom file on the office computer, use the File and Report Generator utility to apply the XSLT style sheet to the Job or JobXML file. For information on using this utility, refer to the *File and Report Generator Help*.
4. To create the custom files on the controller, copy the file to the **System Files** folder on the controller.

## Repairing jobs

The **Job repair** wizard runs when Origin detects damage in the job file. You can cancel the wizard at any point or go back to any previous step.

The wizard retrieves job data up to the point of the damage, discards anything beyond this point, and informs you of the time and date of the last good item in the job.

As a safety measure, the wizard can make a copy of the job before anything is discarded. Before proceeding with the copy, check that the file system has enough space for a copy of the entire job.

Once the repair is completed, ☰ and select **Job data / Review job** to check if anything has been discarded from the end of the job. Because the job is stored in chronological order, anything discarded is timed later than the last good record reported by the wizard.

Be aware that discarded data may include changes made to the job such as deletions (the item may no longer be deleted), changes to antenna or target heights, coordinate systems, and new items such as points, observations, and lines.

Damage to Job files may be caused by a hardware problem, failure to properly shut down the software, or an unexpected power failure due to a flat battery. When the Job wizard reports a problem, review the controller's operating procedure, and/or check the hardware. If you repeatedly experience corruption problems, there may be a fault in your controller hardware. For more information, contact your Spectra Geospatial distributor.



## Job properties

Job properties are configured when a job is created.

To edit the job properties at any time:

1. Tap  and select **Job**. The current job is already selected.
2. Tap **Properties**.
3. To define or change the job properties, tap the appropriate button. Tap:
  - **Coord. sys.** to choose the coordinate system for the job. See [Coordinate system, page 73](#).
  - **Units** to select the units and formats for numerical values. See [Units, page 91](#).
  - **Layer manager** to link point files and map files to the job. See [Layer manager, page 115](#)
  - **Feature library** to associate a feature library with the job. See [Feature library, page 95](#).
  - **Cogo settings** to set the coordinate geometry settings for the job. See [Cogo settings, page 99](#).
  - **Additional settings** to set additional settings for the job. See [Additional settings, page 108](#).
  - **Media file** button to link media files to the job or to points in the job. See [Media files, page 110](#).
  - If required, enter **Reference**, **Description** and **Operator** details, and any **Notes**.

**TIP** – To set default values for the **Reference**, **Description**, **Operator**, or **Notes** fields, use a text editor to modify the **JobDetails.scprf** file in the **C:\ProgramData\Spectra Geospatial Data\System Files** folder.

4. Tap **Accept**.

## Coordinate system

Origin provides a comprehensive database of coordinate systems used around the world. The database is continually updated to reflect changes to different zones. To customize the list of coordinate systems available, see [To customize the coordinate system database, page 88](#).

To select the coordinate system settings for the job from the coordinate system database:

1. Tap  and select **Job**. The current job is already selected.
2. Tap **Properties**.
3. Tap **Coord sys**.
4. In the **Select coordinate system** screen, select **Select from library**. Tap **Next**.

5. From the lists, select the required **System** and **Zone**.

**TIP** – Drag your finger up the list to scroll, or press the first letter of the country name on the keypad to jump to that section of the list.

When you have selected the **System** and **Zone**, the following read-only fields are updated:

- **Local datum:** The local datum for the selected coordinate system and zone.
- **Global reference datum:** The datum of RTK measurements, such as the reference frame of base stations including VRS.
- **Global reference epoch:** The epoch of realization of the **Global reference datum**.
- **Displacement model:** The displacement model used to propagate RTX coordinates between ITRF 2014 at the epoch of measurement and the global reference frame.

**NOTE** – *If you perform an RTK survey in the job, you must make sure the selected real-time correction source is providing GNSS positions in the same datum as that specified in the **Global reference datum** field.*

6. If the job will contain GNSS observations and you want to use a geoid model or datum grid file, you must have copied these files to the controller.
  - a. To select a geoid model, enable the **Use geoid model** switch. Select the file in the **Geoid model** field.
  - b. To select a datum grid file, enable the **Use datum grid** switch. Select the file in the **Datum grid** field.

The semi-major axis and flattening values for the selected datum grid file are displayed.

These details overwrite any already provided by a specified projection.

7. Select the type of **Coordinates** to use. The default is grid. To use ground coordinates, see [To set up a ground coordinate system, page 86](#).
8. Enter the **Project height**. See [Project height, page 85](#).
9. Tap **Store**.

Alternatively, you can define the coordinate system using one of the methods below.

---

 **CAUTION** – Do not change the coordinate system or calibration after you have staked out points, or computed offset or intersection points. If you do, the previously staked out or computed points will be inconsistent with the new coordinate system and any points computed or staked out after the change.

---

### Scale factor only

Use this projection type when the job will contain observations only from a conventional instrument and you are using a local scale factor to reduce distances to the local coordinate system.

**TIP** – If you are working in a small area and are not sure which coordinate system to use, select the **Scale factor only** projection and enter a scale factor of 1.000.

1. In the **Select coordinate system** screen, select **Scale factor only**.
2. Enter a value in the **Scale factor** field.
3. Tap **Store**.

### Key in parameters

Use this method to key in your own parameters, particularly if you have your own projection files you want to use or if the job will contain GNSS observations and you want to key in a site calibration adjustment.

1. In the **Select coordinate system** screen, select **Key in parameters**. Tap **Next**.
2. Tap **Projection**.
  - a. Fill out the details for the projection.

**TIP** – Drag your finger up the list to scroll, or press the first letter of the country name on the keypad to jump to that section of the list.
  - b. Select the type of **Coordinates** to use. The default is grid. To use ground coordinates, see [To set up a ground coordinate system, page 86](#).
  - c. Enter the **Project height**. See [Project height, page 85](#).
  - d. Tap **Accept**.
3. If the job will contain only observations from a conventional instrument, tap **Store**.

4. If the job will contain GNSS observations, or a combination of conventional and GNSS observations:

a. To specify the datum transformation, tap **Datum trans.**

To use a datum grid file, select **Datum grid** in the **Type** field and select the **Datum grid** file to use.

The semi-major axis and flattening values for the selected datum grid file are displayed.

These details overwrite any already provided by a specified projection.

b. To use a geoid model file, tap **Vert. adjustment** and select **Geoid model** and select the **Geoid model** file.

The remaining fields in the **Horizontal adjustment** and **Vertical adjustment** screens are filled out when you perform a site calibration. See [GNSS observations and local coordinate systems, page 80](#) and [Site calibration, page 390](#).

c. Tap **Store**.

#### No projection / no datum

Use this method if you want to measure points using GNSS observations using a coordinate system with an undefined projection and datum, or if you do not know what the coordinate system settings should be.

1. In the **Select coordinate system** screen, select **No projection/no datum**. Tap **Next**.
2. To use ground coordinates after a site calibration, set the **Coordinates** field to **Ground** and enter the average site height in the **Project height** field. Alternatively, set the **Coordinates** field to **Grid**.
3. To calculate a geoid vertical adjustment after a site calibration, select the **Use geoid model** check box and then select the geoid model file.

**NOTE –**

- *If no datum and no projection are defined, you can only stake out lines and points that have **Global** coordinates. Displayed bearings and distances are in terms of **Global reference datum**.*
- *Without a datum transformation, you can only start a real-time base survey with a point that has **Global** coordinates.*

When you perform a site calibration, the software calculates a Transverse Mercator projection and a Molodensky three-parameter datum transformation using the supplied control points. The project height is used to compute a scale factor for the projection so that ground coordinates can be computed at elevation. See [Site calibration, page 390](#).

### Broadcast RTCM

Use this projection type when the **Broadcast format** is set to RTCM RTK and the broadcast datum definition messages are broadcast by the VRS network.

1. In the **Select coordinate system** screen, select **Broadcast RTCM**.
2. Select the appropriate projection parameters for your location.
3. Select the type of **Broadcast RTCM** messages to include. See [Broadcast RTCM coordinate system messages, page 89](#).
4. Select the type of **Coordinates** to use. The default is grid. To use ground coordinates, see [To set up a ground coordinate system, page 86](#).
5. Enter the **Project height**. See [Project height, page 85](#).
6. Tap **Store**.

### Coordinate system name

The name of the coordinate system indicates whether the coordinate system was selected from the library, was later modified, or whether the coordinate system is user defined.

When the coordinate system is:

- Selected from the library:
  - The **Coordinate system** field displays "Zonename (SystemName)".  
Changing the geoid model or project height does not change the name of the coordinate system
  - Editing any projection or datum parameters changes the coordinate system name to "Local site". To remove these changes and revert to the original name of the coordinate system, you must reselect it from the library. If you overlay a GNSS site calibration over this "Local site" the name of the coordinate system remains "Local site".
  - Completing a GNSS site calibration changes the coordinate system name to "Zonename (Site)". If you disable the site calibration (by keying in parameters) the coordinate system name reverts to the original name.
  - Editing any horizontal adjustment or vertical adjustment parameters changes the coordinate system name to "Zonename (Site)". If you remove these changes, the coordinate system name reverts to the original name.
- Defined using **Key in parameters**, the coordinate system name is "Local site".
- Defined using **No projection/no datum**, completing a GNSS site calibration changes the coordinate system name to "Local site".

#### Choosing the coordinate system

Before starting a survey, it is important to choose a suitable coordinate system. The parameters you must configure depend on whether the job contains observations from a conventional instrument or from a GNSS receiver.

---

 **CAUTION** - Do not change the coordinate system or calibration after you have staked out points, or computed offset or intersection points. If you do, the previously staked out or computed points will be inconsistent with the new coordinate system and any points computed or staked out after the change.

---

### Conventional observations only

If the job will contain observations from only a conventional instrument, you can specify the coordinate system and zone by **selecting them from the library** or by **keying in the parameters**. With either method you can use grid or ground coordinates. Grid coordinates are computed at the grid level, which is usually at the ellipsoid level.

Because in a conventional survey measurements are usually made at ground level, you can choose to **use ground coordinates** and then key in the scale factor or calculate the scale factor the software will use when converting ground observations to grid. To use ground coordinates, see [To set up a ground coordinate system, page 86](#).

**TIP** – If you are working in a small area and are not sure which coordinate system to use, select the **Scale factor only** projection and enter a scale factor of 1.000.

### GNSS observations only

If the job will contain GNSS observations, the coordinate system settings will consist of a projection and a datum transformation. You can specify the map projection and datum transformation by **selecting them from the library** or by **keying in the parameters**.

**NOTE** – *If you perform an RTK survey in the job, you must make sure the selected real-time correction source is providing GNSS positions in the same datum as that shown in the **Global reference datum** field in the **Select coordinate system** screen of the job properties.*

When you have chosen a coordinate system, search your survey archives for any horizontal and vertical control points in that coordinate system that are in the area to be surveyed. You can use these to calibrate a GNSS survey. Calibration is the process of adjusting projected (grid) coordinates to fit the local control. Slight discrepancies can exist between local control and GNSS-derived coordinates. These discrepancies can be reduced using minor adjustments. Origin calculates these adjustments when you use the **Site calibration** function. They are called horizontal and vertical adjustments. See [Site calibration, page 390](#).

If you are surveying with VRS and the RTCM broadcast includes coordinate system parameters, you can set the job to use the settings included in the **Broadcast RTCM** messages.

With any of these methods you can use grid or ground coordinates. Grid coordinates are computed at the grid level, which is usually at the ellipsoid level. Because during a survey measurements are usually made at ground level, you can choose to **use ground coordinates** and then key in the scale factor or calculate the scale factor the software will use when converting ground observations to grid. To use ground coordinates, see [To set up a ground coordinate system, page 86](#).

**TIP** – If you are not sure which coordinate system to use, select the **No projection/no datum** option.

## Combining conventional observations with GNSS observations

If you intend to combine conventional observations with GNSS observations, choose a coordinate system that lets you view GNSS observations as grid points. This means that you must define a projection and a datum transformation.

**NOTE** – *You can complete the field work for a combined survey without defining a projection and a datum transformation, but you will not be able to view the GNSS observations as grid coordinates.*

To combine GNSS measurements with two-dimensional conventional observations, specify a project height for the job.

## Coordinate system parameters

A coordinate system locates points in two dimensional or three dimensional space. The coordinate system transforms measurements from a curved surface (the earth) onto a flat surface (a map or plan). A coordinate system consists of at least a map projection and a datum.

## Map projection

A map projection transforms locations from the surface of an ellipsoid into locations on a plane or map using a mathematical model. Transverse Mercator and Lambert are examples of common map projections.

**NOTE** – *Positions on a map projection are commonly called "grid coordinates". Origin abbreviates this to "Grid".*

## Ellipsoid (local datum)

Because an exact model of the earth's surface cannot be created mathematically, localized ellipsoids (mathematical surfaces) have been derived to best represent specific areas. These ellipsoids are sometimes referred to as local datums. NAD 1983, GRS-80, and AGD-66 are examples of local datums.

## GNSS observations and local coordinate systems

GNSS RTK measurements (both single base and VRS) are referenced to the **Global reference datum** defined for the job. However, for most survey tasks, it is better to display and store results in terms of a **local coordinate system**. Before you start a survey, choose a coordinate system and zone. Depending on the requirements of the survey, you can choose to give the results in the national coordinate system, a local coordinate grid system, or as local geodetic coordinates.

In addition to a map projection and local datum, a **local coordinate system** for a GNSS survey consists of:

- datum transformation
- horizontal and vertical adjustments calculated after a site calibration



When **Global** coordinates are transformed onto the local ellipsoid using a datum transformation, local geodetic coordinates result. Local geodetic coordinates are transformed into local grid coordinates using the map projection. The result is northing and easting coordinates on the local grid. If a horizontal adjustment is defined, it is applied next, followed by the vertical adjustment.

**TIP** – When keying in a point or when viewing point details in **Review job** or **Point manager**, you can change the coordinates shown. In the **Coordinate view** field, select **Local** to display local geodetic coordinates. Select **Grid** to display local grid coordinates. See [Coordinate view settings, page 210](#).

**NOTE** – *To conduct a real-time survey in terms of local grid coordinates, define the datum transformation and map projection before starting the survey.*

#### Datum transformation

To survey in a local coordinate system, the GNSS positions in **Global** coordinates must first be transformed onto the local ellipsoid using a datum transformation. For many modern coordinate systems, the **Global reference datum** and the **Local datum** are equivalent. Examples are NAD 1983 and GDA2020. In these cases, there is a "null" transformation between the **Global reference datum** and the **Local datum**. Some older datums require a datum transformation between the **Global reference datum** and the **Local datum**.

Three types of datum transformation are supported:

- **Three-parameter** – The three-parameter transformation involves three simple translations in X, Y, and Z. The three-parameter transformation that Origin uses is a Molodensky transformation, so there may also be a change in ellipsoid radius and flattening.
- **Seven-parameter** – This is the most complex transformation. It applies translations *and* rotations in X, Y, and Z, as well as a scale factor.
- **Datum grid** – This uses a gridded data set of standard datum shifts. By interpolation, it provides an estimated value for a datum transformation at any point on that grid. The accuracy of a datum grid depends on the accuracy of the gridded data set it uses.

A **datum grid transformation** uses interpolative methods to estimate the value of the datum transformation at any point in the area covered by the datum grid files. Two gridded datum files are required for this interpolation – a latitude datum grid file and a longitude datum grid file.

When you export a datum grid using Survey Office, the two datum grid files associated with the current project are combined into a single file for use in the Origin software.

**NOTE** – If you use the Canadian NTV2 datum grid please note the data is provided on an "as is" basis. The Department of Natural Resources Canada (NRCan) makes no guarantees, representations, or warranties respecting the data.

### Calibration

Calibration is the process of adjusting projected (grid) coordinates to fit the local control. A calibration calculates parameters for transforming **Global** coordinates into local grid coordinates (NEE).

You should calculate and apply a calibration before:

- staking out points
- computing offset or intersection points

If you calibrate a project and then survey in real time, the General Survey software gives real-time solutions in terms of the local coordinate system and control points.

You can reuse the calibration from a previous job if the new job is completely encompassed by the initial calibration. If a portion of the new job lies outside the initial project area, introduce additional control points to cover the unknown area. Survey these new points and compute a new calibration, and then use this as the calibration for the job.

To copy the calibration from an existing job to a new job, select the existing job as the current job and then create a new job and in the **Template** field select **Last used job**. Alternatively, use the **Copy between jobs** function to copy the calibration from one job to another.

### Horizontal and vertical adjustments

If published datum transformation parameters are used, slight discrepancies can exist between local control and GNSS-derived coordinates. These discrepancies can be reduced using minor adjustments. Origin calculates these adjustments when you use the **Site calibration** function, if the coordinate system settings for the job include a projection and a datum transformation. They are called horizontal and vertical adjustments.

If required, you can use a geoid model file as part of the vertical adjustment calculation.

### Geoid models

Spectra Geospatial recommends that you use a geoid model to obtain more accurate orthometric heights from your GNSS measurements than from the ellipsoid. If required you can then perform a site calibration to adjust the geoid model by a constant value.

The geoid is a surface of constant gravitational potential that approximates mean sea level. A geoid model or Geoid Grid file (\*.gcf) is a table of geoid-ellipsoid separations that is used with the GNSS ellipsoid height observations to provide an estimate of elevation.

The geoid-ellipsoid separation value ( $N$ ) is obtained from the geoid model and is subtracted from the ellipsoid height ( $H$ ) for a particular point. The elevation ( $h$ ) of the point above mean sea level (the geoid) is the result. This is illustrated in the following diagram:

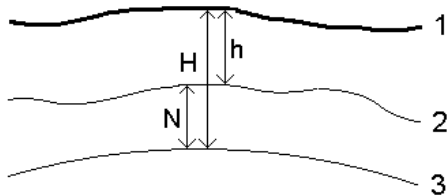

- |   |           |
|---|-----------|
| 1 | Ground    |
| 2 | Geoid     |
| 3 | Ellipsoid |

When you select geoid model as the vertical adjustment type, the software takes the geoid-ellipsoid separations from the geoid file chosen, and uses them to display elevations on the screen.

The benefit using the geoid model for the vertical adjustment is that you can display elevations without having to calibrate on elevation benchmarks. This is useful when local control or benchmarks are not available, as it makes it possible to work "on the ground" rather than on the ellipsoid.

**NOTE** - If you are using a geoid model in a Survey Office project, make sure you transfer that geoid file (or the relevant part of it) when transferring the job to a controller.

### Projection

A projection is used to transform local geodetic coordinates into local grid coordinates. GNSS RTK measurements (both single base and VRS) are referenced to the **Global reference datum** defined for the job.. To work in local grid coordinates during a GNSS survey, you must specify a projection and datum transformation.

You can specify a projection:

- when a job is created and you have to choose a coordinate system (select from a list, or key in)
- during a survey (you calculate values by performing a calibration)
- in the Survey Office software, when the data is transferred.

**NOTE** - Enter an appropriate default height value for the software to correctly calculate a sea level correction and then apply it to the grid coordinate.

**TIP** - If a projection and datum transformation are specified, you can reduce any discrepancies between the **Global** coordinates and the local grid coordinates by performing a site calibration.

## Projection grids

Use a projection grid to handle projection types that are not directly supported by the coordinate system routines provided by the Origin software. A projection grid file stores local latitude and longitude values that correspond to regular northing/easting positions. Depending on the direction of the conversion, either projection or local latitude/longitude positions are interpolated from the grid data for points within the grid extents.

Use the Coordinate System Manager to generate the defined projection grid (\*.pjg) file. For more information, refer to the **Coordinate System Manager Help**. Transfer the projection grid file to the controller.

To use the projection grid, in the **Projection** screen, select **Projection grid** in the **Type** field and then select the **Projection grid file**. If required, select a shift grid.

## Shift grids

Initial projection coordinates are projections that are computed using specified projection routines. Some countries use shift grids to apply corrections to these coordinates. The corrections are generally used to fit the initial coordinates to local distortions in the survey framework, and so cannot be modeled by a simple transformation. You can apply a shift grid to any type of projection definition. Coordinate systems that use shift grids include the Netherlands RD zone, and the United Kingdom OS National Grid zones. The OS National Grid zones are treated as a standard Transverse Mercator projection plus shift grid.

Shift grid files are installed to the desktop computer running the Coordinate System Manager utility, which is installed with Survey Office. Shift grid files can be transferred from the desktop computer to the controller using your favorite [file transfer](#) method.

To apply a shift grid to a projection definition, in the **Projection** screen, enable the **Use shift grid** switch and then select the **Shift grid file**.

## SnakeGrid

**SnakeGrid** is a coordinate system with minimal scale factor and height distortion, even when projects extend for many hundreds of kilometers.

A job using a SnakeGrid coordinate system must use a custom SnakeGrid parameter file. These files are obtained through a licensing arrangement from the UCL Department of Civil, Environmental and Geomatic Engineering. Each SnakeGrid parameter file is customized for a specific project alignment envelope. Go to [www.SnakeGrid.org](http://www.SnakeGrid.org) for details.

**NOTE** - The SnakeGrid parameter file name must be named SnakeXXXXX.dat and placed in the **System Files** folder on the device. See [Data folders, page 46](#).

To choose a SnakeGrid projection, in the **Projection** screen, select **Snakegrid** in the **Type** field and then select the **SnakeGrid parameter file**.

## Project height

The project height can be defined as part of the coordinate system definition when creating a new job. To edit the Project height:

1. Tap  and select **Job**.
2. Tap **Coord Sys**.
3. Select the Select from **library** or **Key in parameters** option. Tap **Next**.
4. Enter the **Project height**.

**TIP** – To automatically complete the **Project height** field when defining or editing the coordinate system, tap **Here** to use the current autonomous height derived by the GNSS receiver, or tap **Point** to use the height of a point in the job or in a linked file.

If a point has no elevation, the Origin software uses the project height in Cogo calculations. If you combine GNSS and 2D conventional observations, set the **Project height** field to approximate the height of the site. This height is used with 2D points to calculate grid and ellipsoid distances from measured ground distances.

In 2D surveys where a projection has been defined, enter a value for the project height that approximates the height of the site. You need this value to reduce measured ground distances to ellipsoid distance, and to compute coordinates.

If you edit the project height (or any other local site parameter) after calibrating, the calibration becomes invalid and must be reapplied.

## Horizontal adjustment

If published datum transformation parameters are used, slight discrepancies can exist between local control and GNSS-derived coordinates. These discrepancies can be reduced using minor adjustments. Origin calculates these adjustments when you use the **Site calibration** function, if the coordinate system settings for the job include a projection and a datum transformation. They are called horizontal and vertical adjustments.

If required, you can use a geoid model file as part of the vertical adjustment calculation.

You can reuse the calibration from a previous job if the new job is completely encompassed by the initial calibration. If a portion of the new job lies outside the initial project area, introduce additional control points to cover the unknown area. Survey these new points and compute a new calibration, and then use this as the calibration for the job.

To copy the calibration from an existing job to a new job, select the existing job as the current job and then create a new job and in the **Template** field select **Last used job**. Alternatively, use the **Copy between jobs** function to copy the calibration from one job to another.

## Vertical adjustment

If published datum transformation parameters are used, slight discrepancies can exist between local control and GNSS-derived coordinates. These discrepancies can be reduced using minor adjustments. Origin calculates these adjustments when you use the **Site calibration** function, if the coordinate system settings for the job include a projection and a datum transformation. They are called horizontal and vertical adjustments.

If required, you can use a geoid model file as part of the vertical adjustment calculation.

You can reuse the calibration from a previous job if the new job is completely encompassed by the initial calibration. If a portion of the new job lies outside the initial project area, introduce additional control points to cover the unknown area. Survey these new points and compute a new calibration, and then use this as the calibration for the job.

To copy the calibration from an existing job to a new job, select the existing job as the current job and then create a new job and in the **Template** field select **Last used job**. Alternatively, use the **Copy between jobs** function to copy the calibration from one job to another.

### To set up a ground coordinate system

If you need coordinates to be at ground level instead of projection level (for example, in areas of high elevation), use a ground coordinate system.

When you set up a ground coordinate system in a job, the software applies a ground scale factor to the coordinate system projection definition so that grid distances equal ground distances.

1. Tap **≡** and select **Job**.
2. Tap **Properties**.
3. In the **Job properties** screen, tap **Coord Sys**.
4. In the **Select coordinate system** screen:
  - Choose the **Select from library** option to select a coordinate system from the library provided. Tap **Next**.
  - Choose the **Key in parameters** option to key in the coordinate system parameters. Tap **Next** and then select **Projection**.
5. To use ground coordinates with the selected coordinate system, from the **Coordinates** field, do one of the following:

- To key in a scale factor, select **Ground (Keyed in scale factor)**. Enter a value in the **Ground scale factor** field.
- To let the Origin software calculate the scale factor, select **Ground (Calculated scale factor)**.

6. If you selected **Ground (Calculated scale factor)**, enter the **Project location**.

Alternatively, do one of the following:

- Tap **Here** to enter the current autonomous position derived by the GNSS receiver. The autonomous position is displayed in terms of the **Global reference datum**.
- Tap **Point** and then select a point from in the job or in a linked file to use the coordinates of that position.

***NOTE** - The **Point** softkey is not available until there are positions in the job. When creating a new job, you must create the job, then link files to the job or measure a new point, and then return to the Job properties and edit the coordinate system settings. The **Point** softkey is now available.*

The project height is used with 2D points to reduce ground distances in Cogo calculations. For more information, see [Project height](#).

These fields are used to calculate the ground scale factor. The computed ground scale factor is displayed in the **Ground scale factor** field. It allows for the projection scale factor at the **Project location** to ensure that the combined factor (point scale factor multiplied by the sea level factor) at the **Project location** equals 1.

The software applies the ground scale factor to the projection.

7. To add offsets to the coordinates to differentiate ground coordinates from unmodified grid coordinates, enter a value in the **False northing offset** and **False easting offset** field.

***NOTE** - When working with a ground coordinate system the reported ground distance may not be the same as the reported grid distance. The reported ground distance is simply the ellipsoid distance corrected for the average height above the ellipsoid. However the grid distance is computed between the ground coordinates of the points, and is therefore based on a coordinate system that provides a combined scale factor of 1 at the Project Location.*

### To customize the coordinate system database

You can customize the coordinate system database used by the Origin software. This enables you to:

- Reduce the number of coordinate systems available so that it includes only the ones you need.
- Customize existing coordinate systems definitions or add new coordinate system definitions.
- Include GNSS site calibrations in the coordinate system library.

You must use the Coordinate System Manager software to modify the Coordinate System Database (CSD) and then transfer the modified database to the **System Files** folder on the controller. When a **custom.csd** file exists in the **C:\ProgramData\Spectra Geospatial Data\System Files** folder, the Origin software uses the **custom.csd** database instead of the coordinate system database built into the software.

**NOTE** – *The Coordinate System Manager software is installed with the Spectra Geospatial Survey Office software.*

### To reduce the coordinate system library to one or more coordinate systems, zones, or sites

1. Run the Coordinate System Manager software on your office computer.
2. To hide the required element:
  - **Coordinate system:** In the left pane of the **Coordinate Systems** tab, select the coordinate system(s) that you do not want, right click and then select **Hide**.
  - **Zone:** In the left pane of the **Coordinate Systems** tab, select a coordinate system, from the right pane, select the Zone(s) you do not want, right click and then select **Hide**.
  - **Site:** From the **Sites** tab, right click the site(s) you do not want and then select **Hide**.
3. Select **File / Save As**.
4. Name the file **custom.csd** and then click **Save**.

By default, the file is saved in **C:\Program Files\Common Files\Spectra Geospatial\GeoData** with the extension \*.csd.

### To export only user-defined coordinate systems

1. Run the Coordinate System Manager software on your office computer.
2. Select **File / Export**.
3. Select **User-defined records only** and then click **OK**.



4. Name the file **custom** and then click **Save**.

By default, the file is saved in **C:\Program Files\Common Files\Spectra Geospatial\GeoData** with the extension \*.csw.

**NOTE** – If a GNSS site calibration has been saved using the Survey Office software, a site with the assigned name is added to the **Sites** tab and a Site group is created in the **Coordinate Systems** tab, if required. When you create a customized coordinate system that includes sites saved by Survey Office, include those sites created in the **Sites** tab. The Site group in the **Coordinate Systems** tab contains the coordinate system details **referenced** by the sites saved in the **Sites** tab, but the calibration details are **only** stored in the site in the **Sites** tab.

#### To transfer custom coordinate systems

Transfer the custom coordinate system file to the controller. The file must be called **custom.csd** For the Origin software to use it, the file must be in the **C:\ProgramData\Spectra Geospatial Data\System Files** folder and named **custom.csd**.

#### To select a custom site

1. In the **Select coordinate system** screen, select **Select from library**. Tap **Next**.
2. If this is a new **custom.csd** file, a warning appears. Tap **OK**.
3. In the **System** field, select **[User sites]**.
4. In the **Site** field, select the required site.
5. If required, select a geoid model.
6. Tap **Store**.

#### Broadcast RTCM coordinate system messages

A Network RTK provider can configure a VRS network to broadcast RTCM coordinate system messages that include some of the coordinate system definition parameters. When the **Broadcast format** is set to **RTCM RTK** in the **Rover options** screen of the survey style, and the RTCM messages are broadcast by the VRS network, Origin can use this to provide the datum and ellipsoid definition for a job. See [Coordinate system, page 73](#).

Originsupports a subset of the RTCM transformation parameters, as shown below:

Message	Details	Supported
1021	Helmert/Abridged Molodensky (Control)	Yes
1022	Molodensky-Badekas Transformation (Control)	Yes

Message	Details	Supported
1023	Ellipsoidal Datum Shift Grid Residual	Yes
1024	Plane Grid Residual	No
1025	Projection	No
1026	Projection Lambert Conformal Conic Two Parallel	No
1027	Projection Oblique Mercator	No
1028	Local Transformation	No

The broadcast RCTM message must contain either the 1021 or the 1022 control message. This defines what other messages will be present. All other messages are optional.

Datum shift grid values are broadcast at fixed time intervals for a grid surrounding the area you are working in. The size of the grid that is broadcast depends on the density of the source grid data. To perform coordinate system transformations, the grid file that is built by Origin must include shift grids covering the location of points you are transforming. When you move to a new location, a new set of datum shift grid values is broadcast and there may be a slight delay until the appropriate values are received from the VRS network server.

The broadcast transformation messages include a unique identifier for the broadcast parameters. If the broadcast parameters change, the identifier changes, and the Origin creates a new grid file to store the new datum grid shift values. A message warns if the broadcast RTCM transformation changes and you are prompted to continue. If you select:

- **Yes** the system creates a new grid file, or, if it exists, uses another grid file that matches the newly broadcast transformation. If you change grid files, the new grid file may not cover the same area as the old grid file, so Origin may not be able to transform points where there are 'holes' in the grid file.
- **No** you cannot continue surveying. Create a new job and start the survey again. If you need access to data in the old job, link that job.

If you copy a job that is defined to use a Broadcast RTCM datum onto a different controller, you should copy the appropriate grid file so that the software can transform grid coordinates on the other controller.

**NOTE** – When a job with broadcast RTCM data is exported as a DC file, the GNSS observations are output as grid positions.

## Units

To configure units and formats for numerical values for the job:

1. Tap  and select **Job**. The current job is already selected.
2. Tap **Properties**.
3. Tap **Units**.
4. Change the fields as required.

**TIP** – Some fields in the Origin software allow you to enter a value in units other than the system units. When you enter a value in one of these fields (for example **Azimuth**) and tap **Enter**, the value is converted to the system units.

## Units

Available unit settings are:

### **Distance and grid coords**

Distance and northing/easting coordinates

### **Height**

Height and elevation

### **Angles**

Angles

### **Quadrant bearings**

Bearing values are automatically converted to quadrant bearings when this check box is enabled.

For example, to enter the quadrant bearing N25° 30' 30"E in a bearing field, key in **25.3030** and then tap  and select **NE**.

### **Temperature**

Temperature

### **Pressure**

Pressure

### **Grade**

The grade of a slope can be displayed as an angle, percent, or ratio.

The ratio can be displayed as **Rise:Run** or **Run:Rise**.

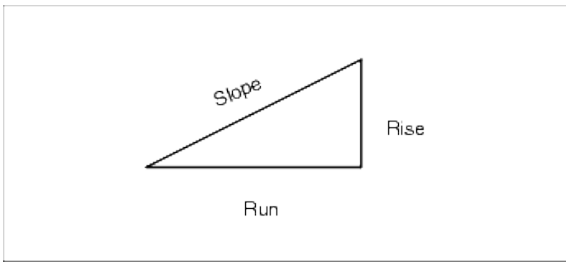

## Area

Supported area units include:

- Square meters
- Square miles
- Square international feet
- Square US survey feet
- Square international yards
- Square US survey yards
- Acres
- Hectares

## Volume

Supported volume units include:

- Cubic meters
- Cubic international feet
- Cubic US survey feet
- Cubic international yards
- Cubic US survey feet
- Acre feet
- US acre feet

[Formats for numerical values](#)

Available formats for numerical values are:

## Distance display

The number of decimal places in all distance fields. When the **Distance and grid coordinates** field is set to US survey feet or international feet you can configure the distance display to be in feet and inches. Supported fractions of an inch include: 1/2", 1/4", 1/8", 1/16" and 1/32".

### **Coordinate display**

The number of decimal places in all northing/easting coordinate fields

### **Area display**

The number of decimal places for a computed area

### **Volume display**

The number of decimal places for a computed volume

### **Angle display**

The number of decimal places for a computed angle.

### **Lat/Long**

Latitude and longitude

### **Coordinate order**

The order for the displayed grid coordinates. Select from:

- North-East-Elev
- East-North-Elev
- Y-X-Z (equivalent to East-North-Elev – field prompts changed)
- X-Y-Z (equivalent to North-East-Elev – field prompts changed)

For the Y-X-Z and X-Y-Z options, the convention used defines that the Y axis is the East axis and the X axis is the North axis.

### **Station display**

(Also known as [Chainage](#) in some countries.)

This defines the distance along a line, arc, alignment, or road.

The station values can be displayed as:

- 1000.0 where the values are displayed as entered
- 10+00.0 where the + separates the hundreds from the remaining values
- 1+000.0 where the + separates the thousands from the remaining values
- **Station index**

The **Station index** display type uses an extra **Station index increment** field value as part of its definition. The station value is displayed as per the 10+00.0 option, but the value before the + is the station value divided by the **Station index increment**. The remainder is displayed after the +. For example if the **Station index increment** is set to 20, a station value of 42.0 m is displayed as 2 + 02.0 m. This display option is used in Brazil but may have application in other markets.

**Station index increment**

If the **Station display** is set to **Station index** the **station index increment** field appears enabling an appropriate station index increment to be entered. See details above.

**Laser VA display**

Laser vertical angles

Can be vertical angles measured from the zenith, or inclinations measured from horizontal.

**Time format**

The format for date and time. Select from:

- Local date/time
- UTC time
- GPS weeks and seconds

**Precision display**

Confidence level of displayed GNSS precision estimates. Supported confidence levels and the likely probability that the precision is within range are:

	Horizontal		Vertical	
	Scalar	Percent	Scalar	Percent
<b>1 sigma</b>	1	39.4%	1	68.3%
<b>95%</b>	2.447	95%	1.960	95%
<b>99%</b>	3.035	99%	2.575	99%

## Feature library

A **feature library** is a text file that contains the definitions of feature codes, attributes, linework, and control codes.

**Control codes** define the relationship between points so that the geometry of a line or polygon is drawn in the map. The easiest way to use **control codes** to create line, arc, and polygon features in the map as you measure points, or by drawing line and arc features using points already in the job is using the [CAD toolbar](#).

An **attribute** is a characteristic or property of a feature in a database. All features have a geographic position as an attribute. Other attributes depend on the type of feature. For example, a road has a name or designation number, surface type, width, number of lanes, and so on. The value chosen to describe a particular feature is called the attribute value.

When you measure a point and select a feature code from the feature library in the **Code** field, if the feature code has attributes then the Origin software prompts you to enter the attribute data.

**NOTE** – If you have enabled **Use descriptions**, you cannot select codes from feature libraries in **Description** fields.

## Supported feature library files

You can create your own feature library using the Feature Definition Manager in the Spectra Geospatial Survey Office software and then transfer the file to the **System Files** folder on the controller. Alternatively, you can create a feature library using Origin.

**NOTE** – Feature codes created using Origin are used only to draw feature geometry. To create a feature library that contains attribute definitions you must use the Feature Definition Manager in Survey Office.

## To select the feature library

To select a code in a survey, the job must be using the feature library that contains the appropriate codes.

To select the library:

1. Tap  and select **Job**. The current job is already selected.
2. Tap **Properties**.
3. Tap **Feature library**. The **Select feature library** screen shows the available feature library files in the **System Files** folder.

4. To add a feature library file from a different folder, tap **Browse** and navigate to the location of the feature library file. Tap the file to select it and tap **Accept**. The file is copied to the **Spectra Geospatial Data / System Files** folder and appears in the **Select feature library** list.
5. Tap the feature library file to select it.

#### Survey Office feature libraries

You can create your own feature library using the Feature Definition Manager in the Spectra Geospatial Survey Office software and then transfer the file to the **System Files** folder on the controller.

Feature code names that contain spaces are shown in Origin with a small dot between the words, for example, Fire.Hydrant. These dots do not appear in the office software.

#### Control codes

If you are using an old FXL file, then the control codes supported depend on the FXL file version.

- Smooth curve control codes need FXL file version 4 or later.
- Rectangle and circle control codes need FXL file version 5 or later.
- Horizontal and vertical offset control codes need FXL file version 6 or later.
- Block control codes need FXL file version 8 or later.

To upgrade older version files select **File / Save As** in the Feature Definition Manager and select the latest **Save As** format.

#### Block codes

Blocks must be created or edited using the Feature Definition Manager in Survey Office. If required, you can change the feature code and feature code description for a block using Origin.

**NOTE** - *Blocks are not actually constructed or displayed in the Origin software. Points with feature codes that reference blocks are displayed with the appropriate block symbols when the file is imported to the Survey Office software version 3.80 or later.*

Block control codes have a **Control code action** field that controls the behavior of the block:



Control code action	Enter this control code to...
Rotation	Rotate the block by the specified value about the current point in a clockwise direction.
Scale X	Scale the block along the X axis.
Scale Y	Scale the block along the Y axis.
Scale Z	Scale a 3D block along the Z axis.
From 1 point	Specify the construction of a block using the current point as the insertion point.
From 2 points	Specify the construction of a block using the current and next point as insertion points.
From 3 points	Specify the construction of a block using the current and next two points as insertion points.

### Symbology

The colors defined in the FXL file created using the Feature Definition Manager software may not be identical to the colors used by the Origin software.

Colors can be defined in the Feature Definition Manager as **By layer** or **Custom**.

- When **By layer** has been defined, by default Origin uses black.
- When **Custom** has been defined, by default Origin uses the closest color match to the Origin palette.

Where **By layer** or **Custom** has been defined, you can change the default Origin color to a different color but if you do this you cannot change it again.

The Origin software does not fill feature coded polygons.

Some symbols are not supported in feature libraries, for example ! and [ ]. If you use unsupported symbols when creating a library in the office software, the Origin software converts them to the underscore symbol "\_" when they are transferred. All line features that are coded as white are drawn in black.

To add or edit a feature library in Origin

**NOTE** - Feature codes created using Origin are used only to draw feature geometry. To create a feature library that contains attribute definitions you must use the Feature Definition Manager in Survey Office.

### To add an existing feature library

1. Tap  and select **Settings / Feature Libraries**.
2. Tap **Browse**.
3. Navigate to the location of the feature library file.
4. Tap the file to select it and tap **Accept**.

The file is copied to the **System Files** folder in the **Spectra Geospatial Data** folder and appears in the **Select feature library** list.

### To create a new feature library in the Origin software

1. Tap  and select **Settings / Feature Libraries**.
2. Tap **New**.
3. Enter the name.
4. Tap **Accept**.

### To add or edit feature codes in the feature library

1. Tap  and select **Settings / Feature Libraries**.
2. Select the feature library in the list. Tap **Edit**.
3. To add a new feature code:
  - a. Tap **Add**.
  - b. Enter the **Feature code**.

The maximum length of this field is 20 characters. Spectra Geospatial recommends keeping code names short and meaningful to allow multiple codes to be selected for a point. When selecting codes for a point, the maximum length of the **Code** field is 60 characters.

Feature code names that contain spaces are shown in Origin with a small dot between the words, for example, **Fire.Hydrant**. These dots do not appear in the office software.

- c. If required, enter a **Description** for the code.

By default, if the code is a control code the value of the **Control code action** field appears in the **Description** field when viewing the **Code list**.

- d. Select the **Feature type**. If you select any feature type except **Point**, additional fields appear.
- e. If the **Feature type** is a:
  - **Line**, select the line style and color.
  - **Polygon**, select the line style and border color.
  - **Control code**, select the control code action.
- f. Select the **Layer**.

If there were no layers defined when the Feature Library FXL file was created using the Feature Definition Manager in Survey Office, then the **0** layer is selected.

- g. Tap **Accept**.

4. Tap **Store**.

### Cogo settings

To configure Cogo settings for the job:

1. Tap  and select **Job**. The current job is already selected.
2. Tap **Properties**.
3. Tap **Cogo settings**.
4. Change the fields as required.

### Distance display and calculation

The **Distances** field specifies how distances are displayed and calculated in the software. The **Distances** field appears in the **Cogo settings** screen and in some Key in and Cogo **Options** screens.

When Distances are set to...	The length or area is computed...
Ground	At the mean ground elevation
Ellipsoid	On the ellipsoid surface
Grid	Directly off the grid coordinates

The following diagram shows the options between points A and B.

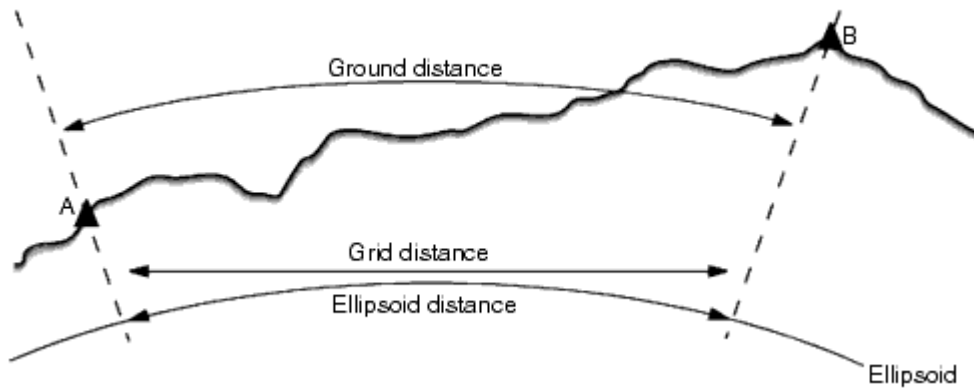

**NOTE** – If the coordinate system for a job is defined as **Scale factor only**, ellipsoid distances cannot be displayed.

#### Ground distance

A ground distance is the horizontal distance calculated between the two points at the mean elevation parallel to the chosen ellipsoid.

If an ellipsoid has been defined in the job and the **Distances** field is set to **Ground**, the distance is calculated parallel to that. If no ellipsoid has been defined, the WGS-84 ellipsoid is used.

#### Ellipsoid distance

If the **Distances** field is set to **Ellipsoid** then a correction is applied and all distances are calculated as if on the local ellipsoid, which usually approximates to sea level. If no ellipsoid has been specified, the WGS-84 ellipsoid is used.

#### Grid distance

If the **Distances** field is set to **Grid**, the grid distance between two points is displayed. This is the simple trigonometrical distance between the two sets of two-dimensional coordinates. If the coordinate system for the job is defined as **Scale factor only**, and the **Distances** field is set to **Grid**, the software displays ground distances multiplied by the scale factor.

To perform Cogo calculations in a **No projection / No datum** coordinate system, set the **Distances** field to **Grid**. The software then performs standard Cartesian computations. If the grid distances you enter are distances on the ground, the new computed grid coordinates will be ground coordinates.

**NOTE** – A grid distance between two measured GNSS points cannot be displayed unless you have specified a datum transformation and a projection, or performed a site calibration.

#### Curvature correction

In Origin, all ellipsoid and ground distances are parallel to the ellipsoid.

## Sea level (ellipsoid) correction

Select the **Sea level (ellipsoid) correction** check box if the horizontal components of distances measured with a conventional total station should be corrected to their equivalent length on the ellipsoid.

In most cases, Spectra Geospatial recommends selecting the **Sea level (ellipsoid) correction** check box to compute the correct geodetic grid coordinates from the total station observations. However, if the local ellipsoid was inflated to provide computed ground coordinates, but the point heights were not changed to be in terms of the inflated ellipsoid, do not select sea level correction; for example, when using jobs with Minnesota county coordinate systems.

The sea level correction is carried out using the average height (not elevation) of the line above the local ellipsoid. If both ends of the line have null heights, the default height specified for the job is used to compute this correction.

The formula used for the computation is:

**Ellipsoid horizontal distance = HzDist x Radius / (Radius + AvHt)**

HzDist:	Horizontal component of measured distance
Radius:	Ellipsoid semi-major axis
AvHt:	Average height above local ellipsoid of the measured line

### **NOTE -**

- *In jobs where the coordinate system is configured to provide ground coordinates, the **Sea level (ellipsoid) correction** is always enabled and cannot be edited. This is because the sea level correction is already applied in the computation of the ground coordinates.*
- *In a Scale only job, there is no local ellipsoid available because this is not a geodetic projection. In this case, the correction computation defaults to using the semi-major axis of the WGS-84 ellipsoid (6378137.0 m) as the radius value. The sea level correction in Scale only jobs also uses the point elevations because there are no ellipsoidal heights available.*
- *You cannot set a default height for Scale only jobs. This means that if the **Sea level (ellipsoid) correction** is enabled in a Scale only job, you must use 3D points, or null coordinates will be computed because it is not possible to compute the sea level correction.*

### Grid coordinate direction

Use the **Grid coords** field to set the grid coordinates to increase in one of the following sets of directions:

- north and east
- south and west
- north and west
- south and east

The following diagram shows the effect of each setting.

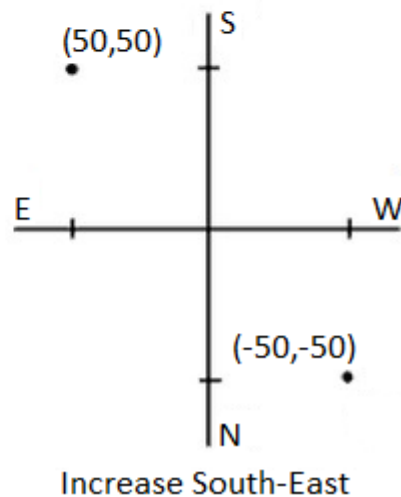
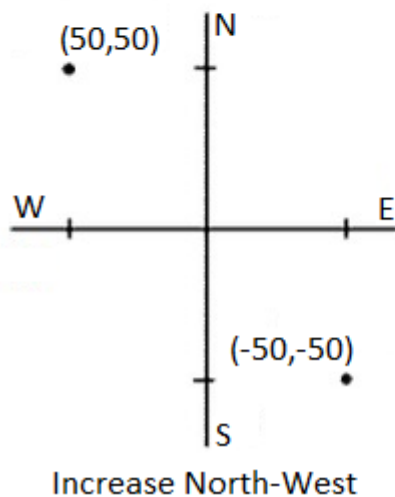
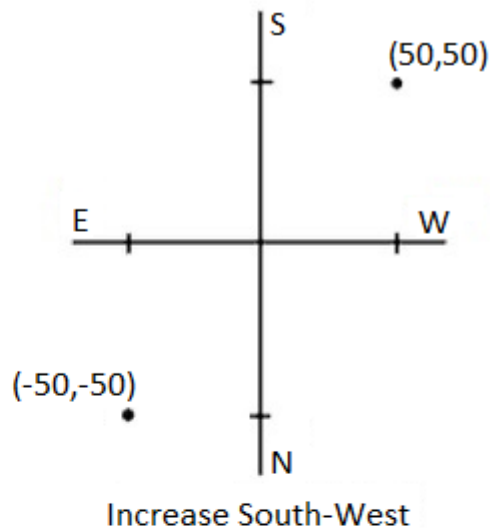
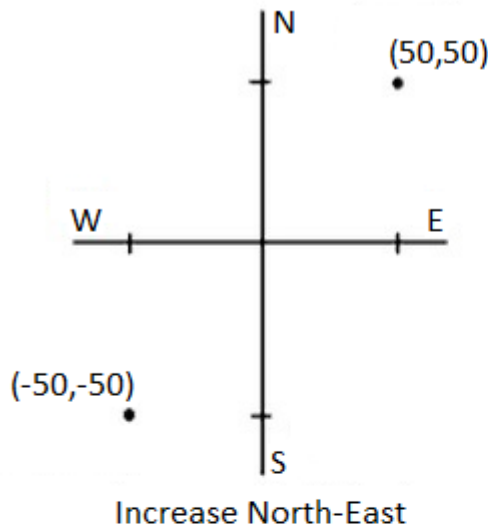

### Azimuth display

The azimuth displayed and used by the software depends on the coordinate system that you defined for the current job:

- If you defined both a datum transformation and a projection, or if you selected **Scale factor only**, the grid azimuth is displayed.

- If you defined no datum transformation and/or no projection, the best available azimuth is displayed. A grid azimuth is the first choice, then a local ellipsoidal azimuth, then the WGS-84 ellipsoid azimuth.
- If you are using a laser rangefinder, the magnetic azimuth is displayed.

If a south azimuth display is required, set the **South azimuth** field to **Yes**. All azimuths still increase clockwise. The following diagram shows the effect of setting the **South azimuth** fields to No or Yes.

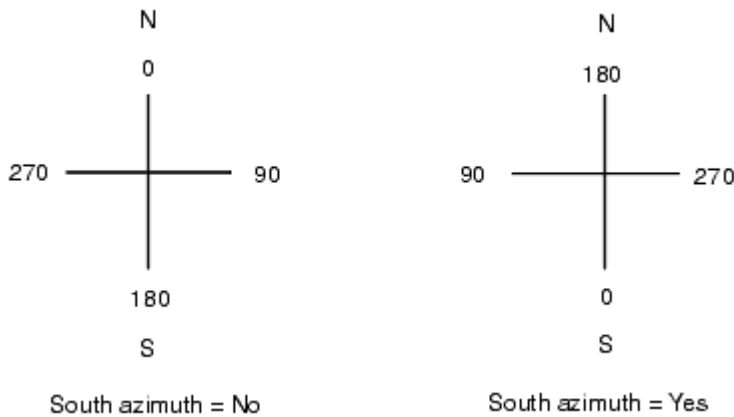

### Neighborhood adjustment

To apply a neighborhood adjustment to all conventional foresight observations made from a Station setup plus or Resection, and to all GNSS observations made in a job that has a valid site calibration, select the **Neighborhood adjustment** check box.

Neighborhood adjustment uses the residuals from **Station setup plus, Resection** or **GNSS site calibration** to calculate delta grid values to apply to subsequent observations made during the survey. Each observation is adjusted according to its distance from each of the backsight points (for a conventional survey) or calibration points (for a GNSS survey). The following formula is used to calculate the weight to give the residuals of each backsight or calibration point:

$$p = 1/D^n \text{ where:}$$

p is the weight of the backsight or calibration point

D is the distance to the backsight or calibration point

n is the weight exponent

A weighted average is then computed and the resulting delta values are applied to each new observation to get an adjusted grid position.



**NOTE** – A high value for the weight exponent results in low impact (weight) of distant backsight or calibration points.

For **Neighborhood adjustment** to be applied, the station setup or calibration must have at least 3 known points with 2D grid residuals. That is, if you perform a:

- Station setup plus, you must have HA VA SD observations to at least 2 backsight points, each with known 2D coordinates.
- Resection, you must have HA VA SD observations to at least 3 backsight points, each with known 2D coordinates.
- Calibration, you must have GNSS observations to at least 3 control points, each with known 2D coordinates.

**NOTE** –

- Neighborhood adjustment will use a **GNSS site calibration** only if it has been observed in the current job. This is because a GNSS calibration that is part of the coordinate system in an uploaded job does not include the GNSS calibration residuals.
- For **Station setup plus**, the known station coordinate is included in the neighborhood adjustment calculation. In the calculation, the station coordinate is given grid residuals of zero.
- Neighborhood adjustment is a 2D-only adjustment. Any vertical residuals from station setup or calibration are not used in the neighborhood adjustment calculations.
- Neighborhood adjustment using GNSS site calibration residuals is applied to all WGS-84 points in the job, not just GNSS observations.



**WARNING** – Make sure that the backsight or calibration points are around the perimeter of the site. Do not survey outside the area enclosed by the backsight or calibration points (and for Station setup plus, the station point). The neighborhood adjustment is not valid beyond this perimeter.

---

### Reference azimuth

If you know the reference azimuth for the job, for example when working from a BIM model or IFC file, enter the value in the **Reference azimuth** field.

**NOTE** – 3D map views (*Top, Front, Back, Left, Right*) are always oriented to the **Reference azimuth**. The **Reference azimuth** is also used by the map **Limit box** to align the Limit box sliders with map data. See [Limit box, page 170](#).

You can edit the **Reference azimuth** at any time by editing the value in the **Reference azimuth** field in the **Map settings** screen. The plan view in the map is oriented to North by default, but you can choose to orient it to the **Reference azimuth** if required. For more information, including on how to find the azimuth of a line in the job and use that value as the **Reference azimuth**, see [Map settings, page 139](#).

When staking a point in a GNSS survey, you can also edit the **Reference azimuth** value when you select **Relative to azimuth** from the **Stake** field. See [GNSS stake methods, page 517](#).

### Magnetic declination

Set the magnetic declination for the local area if magnetic bearings are being used in the Origin software. You can use magnetic bearings if you choose the **Cogo / Compute** point using the Brng-dist from a point method.

The magnetic declination defines the relationship between magnetic north and grid north for the job. Enter a negative value if magnetic north is west of grid north. Enter a positive value if magnetic north is east of grid north. For example, if the compass needle points 7° to the east of grid north, the declination is +7° or 7°E.

### **NOTE** –

- Use the published declination values if available.
- If grid north in the job has been rotated away from true north due to the coordinate system definition (possibly via a GNSS calibration) then this must be allowed for in the magnetic declination specified.

### Advanced Geodetic

Select **Advanced Geodetic** to enable the following options:

- Station setup scale factor – see [Station setup options, page 301](#)
- Helmert transformation for resection – see [To complete a resection, page 307](#)
- Local transformations – see [Transformations, page 261](#)
- SnakeGrid projections – see [Projection, page 83](#)

## Averaging

The **Averaging** field defines how duplicate points are averaged. Select one of the following options:

- Weighted
- Unweighted

If **Weighted** is selected, points in an average are weighted as follows:

- GNSS positions use the horizontal and vertical precisions of the observations. Observations that do not have precisions, and keyed-in points, use 10 mm for horizontal and 20 mm for vertical.
- For conventional observations that include a measured slope distance, horizontal and vertical standard errors are computed based on the standard errors of the components of the observation.

The standard error used for weighting the horizontal position is a combination of those used for the horizontal direction and horizontal distance weights from the resection calculation.

Averaging uses **Least squares** to average points/observations stored with the same name in the job.

- If the average includes positions in any coordinates except ECEF or **Global** coordinates, the average is stored as a grid.
- GNSS observations and conventional observations that include a measured slope distance are resolved to grid and then averaged using Least squares. The intersections of angles only conventional observations are averaged using Least squares.
- Conventional angle-only observations are only added to the solution if there are no other positions or observations. Any Mean Turned Angle (MTA) observed to the point is ignored and the original observations are used to compute the average position.
- When the average includes only positions in ECEF or **Global** coordinates, the averaged grid position is converted to **Global** coordinates and stored. When the average contains only grid positions and conventional observations, or a mixture of position types, then the averaged grid position is stored as a grid.

**NOTE** - *An averaged position is not automatically updated if the positions used to compute the average are changed. For example, if the calibration is updated, if observations are transformed or deleted, or if new observations of the same name are added, recompute the averaged position.*

## Additional settings

To configure additional settings, such as adding description fields or configuring the point range for the job, or to add measured points to a CSV file:

1. Tap  and select **Job**. The current job is already selected.
2. Tap **Properties**.
3. Tap **Additional settings**.
4. Change the fields as required.

## Use descriptions

To display two additional description fields in some software screens, enable the **Use descriptions** switch and then enter the **Description 1 label** and **Description 2 label**.

The description fields are similar to **Code** fields because they enable you to add additional information to data. They do not use feature code libraries, and they do not support attributes.

Once the additional descriptions fields are enabled, they are available in the following features of the Origin software:

- Measure topo, Continuous topo or Measure codes
- Stakeout
- Point manager or Review job
- Key in point, line, and arc
- Compute point, Compute average, Transformations, or Traverse
- Station setup
- Wildcard search

Each of the **Description** fields remembers the descriptions that are entered. To view the stack of previously used descriptions, tap  next to the **Description** field.

The description field data is available in Trimble DC files as **Note** records. If required, you can export the data stored in the description fields.

## Feature library – Use attributes of base code

Select the **Use attributes of base code** check box to provide attributes for the complete code, or from a portion of the code – the "base code". This setting is applied throughout the Origin software, including [Measuring and coding observations in one step, page 490](#).

Typically, base codes are used when you use the + and - softkeys to "string" feature codes.

For example, when you code a fence where all observations coded "Fence01" are joined together and all observations coded "Fence02" are joined together, and so on, and they all have the same attributes. In this example, you can create feature code libraries that contain all the "Fence\*\*" codes, or contain just the base code "Fence".

If you do string codes, and the feature library includes only the base code, then select the **Use attributes of base code** check box.

If you do not string codes, or if you do string codes but you include the entire code in the feature library, then you are not using base codes and you should clear the **Use attributes of base code** check box.

For more information, see [Use attributes of base code, page 495](#) in the [Measure code options, page 494](#).

#### Add to CSV file

To add points measured using **Measure topo** or **Measure rounds** to a CSV file, enable the **Enable** switch and then enter the **CSV file name**. By default, the CSV file is stored in the current project folder.

**TIP** – You can use this option to create a file of control points.

#### Point name range for the job

To specify the minimum and maximum point name for the job, enable the **Apply point name range** switch and then enter the required point names.

**NOTE** – *The point names must be numeric. Numbers that include decimal points or alphabetic characters are ignored. Negative and positive numbers are supported.*

#### Next point names

Origin supports using different point names for different types of points. When creating a new job you can configure whether the point names in the new job auto increment from the last used job, or start based on the values set in your job template. You can edit the next point name fields when creating the new job or at any time in an existing job.

To specify the next point name for different point types, enter the required point name in the appropriate field(s). To use the same point name thread for different types of points, for example Topo points and Rapid points, set the **Next point names** for both **Measure points** and **Rapid points** to the same name.

Available point types include measured points, stake out points, keyed in points, construction points, laser points, lines, arcs and polylines.

When creating a new job:

- If you have selected **Last used job** as the template, the default values for the next point name fields will continue from the last used job.
- If you have selected a template, select one of these options to determine the default name of the next point:
  - **Continue from last job:** Populates the next point name fields with the next available point name from the **last used job**.
  - **Template:** Populates the next point name fields with the names specified in the template.

### Media files

Configure media file settings at the job level so that when the image is captured the Origin knows whether to link the file to the job or a point in the job. For more information on media files and how to use them, see [Working with media files, page 182](#).

1. Tap  and select **Job**. The current job is already selected.
2. Tap **Properties**.
3. Tap **Media files**.
4. In the **Link to** field, select how the images will be linked. Choose from:
  - **Job** – linked to the job
  - **Previous point** – linked to the latest point stored
  - **Next point** – linked to the next point to be stored
  - **Point name** – linked to the point entered in the **Point name** field
  - **None** – the image is saved but is not linked to the job or a point

**NOTE** – For all options, the media file is always saved to the **<project>\<job name> Files** folder. If there is no job open, the media file is saved to the current project folder.

5. Select the **Show with new media file** option to show the media file screen immediately after capturing an image. This enables the **Link to** method to be changed and, if linking by point name, the point name. Changing this setting applies the setting to all jobs.

6. If the **Link to** option was set to **Previous point**, **Next point**, or **Point name**, you can select **Geotag images**. See [To geotag an image, page 184](#).
7. Tap **Accept**.

## Job data

When you open a job, the map appears, giving you visual access to data in the job and in files linked to the job.

Use the **Job data** menu to view job data in tabulated form in the Point Manager screen or as a history of changes in the job in the Review job screen.

From the **Job data** menu you can also return to the map or open Windows Explorer, so that you can easily transfer files into the **Spectra Geospatial Data** folder. See [File transfer, page 50](#).

## Selecting points

There are a number of ways you can select the point or group of points you want to work with.

### To enter a point name

For any field that requires a point name, you can:

- Tap the point in the map to select it.
- Type in the name of an existing point.
- Tap ► next to the field and then select one of the options below to create or select the point.

Select...	To...
List	Select from a list of all points in the job.
Wildcard search	Search the job using a filter.
Key in	Create a point by keying in the <b>Point name</b> , <b>Code</b> , and <b>Coordinates</b> .
Fast fix	Quickly measure and automatically store a point. Wherever the instrument is pointing, that position is stored.



Select...	To...
Measure	View the Measure screen so that you can enter the <b>Point name, Code, and Target height.</b>
Map selections	View a list of points selected from the map.

### To select features from the map

To select features such as points, lines, or arcs from any supported map file type except background images, you can select them from the map. See [Selecting items in the map](#).

To select a feature from a linked file, the file or feature layer within the file must be made selectable. See [To manage map files, page 118](#).

### To select points in the job or linked files that match selected criteria

1. Tap and hold in the map and tap **Select**.
2. Select whether to include points from the **Current job** or the **Current job and linked files**.
3. Define your selection using any combination of the following fields:
  - **Point name or Point range**  
Tap  to toggle between the **Point name** field and the **Point range (From point, To point)** fields.
  - **Code**
  - **Description 1 and Description 2**  
Description fields appear only if the **Use description fields** option is enabled in the job properties.
  - **Minimum elevation**
  - **Maximum elevation**

**TIP** – Use wildcards in these fields to make multiple selections. Use \* for multiple characters, and ? for a single character.

4. If points are already selected, an **Append to current selection** check box appears on screen. Clear this option if you want to overwrite the current selection.
5. Tap **Accept**.

Any point selections made in the **Select** screen can be edited in the map view. See [Selecting items in the map](#).

#### To create a list of points

If you have a large number of points in the job you can create a list of points to work from.

The Origin software allows you to perform some functions, such as [staking points](#), [applying a transformation](#), [defining a plane](#) and [export](#), on the list of points.

To create the list of points, tap **Add** in any software screen that supports working from a list and then use one of the following methods to add points:

Method	Description
Enter single point name	Enter a single point name in the current job or linked files. To enter a point from a linked file into a <b>Point name</b> field, access the field and key in the point name. A linked point entered into a point name field is copied into the current job database.
Select from list	Select from a list of all points in the current job and linked files. Tap a column name to sort points by that column.
Select using wildcard search	Select from a filtered list of all points in the current job and linked files.
Select from file	Add all points from a defined CSV or TXT file.
All grid points	Add all grid points from the current job.
All keyed in points	Add all keyed in points from the current job.
Points within radius	Add all points within a defined radius from the current job and linked files.
All points	Add all points from the current job and linked files.
Points with same code	Add all points with a defined code from the current job and linked files.

Method	Description
Points by name range	Add all points within a name range from the current job and linked files.
Section of job	Add all points in chronological order from the first occurrence of "From point" through to and including the first occurrence of "To point".
Map selection	Any points currently selected in the map are listed. Add more points by selecting them in the map. Tap points to select them in the map or tap them again to deselect them. Alternatively, use the softkeys below the map to add or remove points from the list.

**NOTE -**

- The **Current map selection** method is not available when applying a transformation. However, any points selected in the map automatically populate the list.
- When you add points to the list for stakeout using the **Select from file** option, you can add them from the linked file even if the point in the linked file already exists in the current job. The **Select from file** option is the only way you can [stake a point](#) from a linked file when a point of the same name exists in the current job.
- If a linked job contains two points of the same name, the point with the higher class is displayed.

## Layer manager

Use the **Layer manager** to link files to the job and to manage the data that is visible in the **Map** screen.

To open the **Layer manager**, do one of the following:

- Tap  in the **Map** toolbar.
- In the **Job properties** screen, tap the **Layer manager** button.

The **Layer manager** provides tabs for managing different types of data:



- [Use the Point files tab](#) to link point files (CSV, TXT, and job files) so that you can view and use the points in the file without importing them into the job.
- [Use the Map files tab](#) to:

- Link [supported map files](#) (including IFC, RXL, image, and surface files) to the job to provide background maps and context information for the data in the job.
- Make features in linked files visible and/or selectable so that you can work with them. Features that are selectable can be used in various software functions, including navigating to a point, staking out, and some Cogo functions.
- Configure a web map service (WMS) and view map background data provided by the service.
- [Use the Filter tab](#) to filter the job data shown by measurement type or by creating a wildcard search.
- [Use the Features tab](#) to make features in the job visible and/or selectable by feature layer. The feature layers listed are determined by the [Feature Library FXL file](#) linked to the job and by the feature codes used in the job.

To automatically update the data shown in the map as you make changes in the **Layer manager**, tap the **Auto update** softkey. A check mark on the **Auto update** softkey indicates **Auto update** is enabled.

**NOTE** – Changes made when **Auto update** is enabled are retained when you exit the **Layer manager** using either the **Accept** or **Esc** key.

**TIP** – To view more of the **Layer manager** form when it is open alongside the map:

- In landscape mode, tap  and swipe left. The form will resize to the closest preset position.
- In portrait mode, tap  and swipe down to view more of the form

For more tips on resizing forms, see [The Origin workspace, page 20](#).

### To manage point files

The **Point files** tab in the **Layer manager** screen lists the CSV, TXT and job files in the current [project folder](#).

Use the **Point files** tab to link CSV, TXT or job files so that you have access to the points in those files without [importing the points](#) into the job. This is especially useful when using a file containing control points.

**NOTE** – When using points from linked files, make sure that they use the same coordinate system as the job that they are being brought into. The coordinate order (northing and easting ordinates) in the comma delimited file must be the same as the setting in the **Coordinate order** field in the **Units**

screen. Make sure the data in the file is in the format: Point name, First ordinate (Northing or Easting), Second ordinate (Northing or Easting), Elevation, Point code.

You can use points from a linked file to:

- stake out without having the design points in the job
- enter values into **Point name** fields, such as for Cogo functions
- navigate to control or check shots from previous surveys

You cannot use lines, arcs or polylines in a linked job.

You can link multiple files. When the point does not exist in the current job, but does exist in multiple linked files, the point in the first linked file is used. If multiple points of the same name exist in a linked job, the [search rules](#) work within that job to find the best point.

Linked points from a CSV file are shown in the **Map** as a blue comma ( , ). Linked points from another job are shown using their original point symbol, but are colored blue. Once you select a linked point and use it for a software function, the linked point is copied into the current job, and is shown as a "c" in the map.

To automatically update the data shown in the Map as you make changes in the **Layer manager**, tap the **Auto update** softkey. A check mark on the **Auto update** softkey indicates **Auto update** is enabled.

**NOTE** - Changes made when **Auto update** is enabled are retained when you exit the **Layer manager** using either the **Accept** or **Esc** key.

To link point files to the job

1. To open the **Layer manager**, do one of the following:
  - Tap  in the **Map** toolbar.
  - In the **Job properties** screen, tap the **Layer manager** button.
2. Select the **Point files** tab.
3. To add files from another folder to the list, tap **Browse**, navigate to the required folder and then select the file(s) to add.

If you add a file that is stored on a USB drive the software automatically copies the file to the current project folder and then links to that file.

4. In the **Point files** tab, tap the file(s) that you want to link to the current job or tap **All** to select all files.

A check mark inside a square  indicates the points in the file are visible and selectable.

5. Tap **Accept**.

#### To specify the point coordinate type

If the **Advanced geodetic** check box is enabled in the **Cogo settings** screen, and you select a CSV or TXT file, you must specify the **Coordinate type** of the points in the file.

1. In the **Point files** tab, tap the file that you want to link to the current job.
2. Select **Grid points** or **Grid (local) points**.
3. If the points in the file are **Grid (local) points**, select the transformation to use to transform them to grid points:
  - To assign the transformation later, select **Not applied, this will be defined later**. Tap **Accept**.  
**TIP** – If you select this option and you later decide to assign an input transformation to this file, you must unlink and then relink the file.
  - To create a new display transformation, select **Create new transformation**. Tap **Next** and complete the required steps. See [Transformations, page 261](#).
  - To select an existing display transformation, select **Select transformation**. Select the display transformation from the list. Tap **Accept**.

4. Tap **Accept**.

For more information on Grid (local) coordinates, see [Local transformations](#).

#### To manage map files

The **Map files** tab in the **Layer manager** screen lists the map files in the current [project folder](#). Map files include IFC or TrimBIM files, RXL files, raster image files, and TTM surface files. See [Supported map files, page 128](#).

Use the **Map files** tab to:

- Link [supported map files](#) (including IFC, RXL, image, and surface files) to the job to provide background maps and context information for the data in the job.

- Make features in linked files visible and/or selectable so that you can work with them. Features that are selectable can be used in various software functions, including navigating to a point, staking out, and some Cogo functions.
- Configure a web map service (WMS) and view map background data provided by the service. See [To manage web map services \(WMS\)](#).

To automatically update the data shown in the Map as you make changes in the **Layer manager**, tap the **Auto update** softkey. A check mark on the **Auto update** softkey indicates **Auto update** is enabled.

**NOTE** – Changes made when **Auto update** is enabled are retained when you exit the **Layer manager** using either the **Accept** or **Esc** key.

#### To link map files to the job

1. To open the **Layer manager**, do one of the following:



- Tap  in the **Map** toolbar.
- In the **Job properties** screen, tap the **Layer manager** button.

2. Select the **Map files** tab.

**TIP** – If the file you want to link is not shown, make sure it is a [supported file type](#) and that the file name does not contain invalid characters (such as a dollar sign or parentheses).



3. To add files from another folder to the list, tap **Browse**, navigate to the required folder and then select the files to add.

If you add a map file that is stored on a USB drive the software automatically copies the file to the current project folder and then links to that file.

4. In the **Map files** tab, tap the file(s) that you want to link to the current job or tap **All** to select all files. A check mark  indicates the files are visible in the map.
5. To make the features in the file(s) selectable, tap the file(s) again. A check mark inside a square  indicates the features are selectable.

**NOTE** – If the icon does not change, the file does not contain any features that can be selected.

6. If the file contains layers, by default all layers have the same setting as the file. To make only some layers visible or selectable, tap the arrow next to the file name and then tap each layer once to hide it, or twice to make it visible but not selectable. Tap the layer again to make it visible and selectable.



The icon next to the file name indicates if some layers are not visible  or not selectable .

7. Tap **Accept**.





#### To change which features in linked map files are visible or selectable

To change the features that are visible and selectable at any time, tap  in the map toolbar and select the **Map files** tab. Showing and hiding features can be useful to reduce visual clutter or to make it easier to select features that are close to other features.

To control which features are visible or selectable per file:

- To display all features in the file, tap the file name once. The check mark  next to the file name indicates the features in the file are displayed.
- To make all features in the file selectable, tap the file name twice. The check mark inside a square  indicates the features in the file are selectable.
- To disable all features in the file, tap the file name three times. No icon next to the file name indicates the features in the file are not shown and are not selectable.

If the file is a DXF, IFC, LandXML, or Shapefile:

- To expand or collapse the file contents to view the layers, tap the arrow next to the file name.
- To display all features in the layer, tap the layer name once. The check mark  next to the layer name indicates the features in the layer are displayed. If features in only some layers are displayed, the check mark next to the file name is gray .
- To make all features in the layer selectable, tap the layer name twice. The check mark inside a square  indicates the features in the file are selectable. If features in only some layers are selected, the check mark inside a square next to the file name is gray .
- To disable all features in the layer, tap the layer name three times. No icon next to the layer



name indicates the features in the layer are not shown and are not selectable.

- An  icon indicates the file does not contain any features that can be displayed.

**TIP** – To see more clearly inside a model, use the **Limit box** to exclude parts of the model such as floors or exterior walls. See [Limit box, page 170](#).

### To manage web map services (WMS)

Map backgrounds provide context for your data. If the controller is connected to the Internet, you can use an online map provided by a web map service (WMS), instead of adding your own background images.

Available web map services depend on your location. To use a web map service, add the WMS and enter the URL you use to retrieve data from the service. Origin saves the configuration information for each WMS in a .wms configuration file in the **C:\ProgramData\Spectra Geospatial Data\System Files** folder.

When connected to the WMS, you can control the visibility of WMS data (including sublayers) in the **Map files** tab of the **Layer manager** screen.

Data from the web map service appears in the map only when the map is in **Plan view**.

**TIP** – If required, you can use data from more than one WMS at the same time. For example, you may want to view cadastral layers from one WMS and data layers such as roads or land parcels from another.

### Before you can use a WMS

- The controller must be connected to the Internet. See [Internet connection setup](#).
- You must know the URL to use for the WMS.

If you need to enter user credentials such as a login name and password, the WMS you subscribe to will provide a URL that includes user login credentials.

Some web map services also require the version to be added as a parameter to the URL. For example: **<https://examplewms.org/wms?version=1.1>**.

- The job must use the same coordinate system and zone as the EPSG code you will select for the WMS.

To find out the EPSG code for the coordinate system and zone you are using, visit the EPSG.io website: <https://epsg.io/>.

## To add a WMS

To open the **Layer manager**, do one of the following:

- Tap  in the **Map** toolbar.
- In the **Job properties** screen, tap the **Layer manager** button.

1. Select the **Map files** tab.
2. Tap **WMS**. (In portrait mode, swipe right to left along the row of softkeys to view the **WMS** softkey.)
3. In the **Web map service** screen, tap **New**.
4. Enter the **Name** of the web map service.
5. Enter the **URL** of the web map service and tap **Enter**.
6. Wait while the software retrieves information from the web map service.

**TIP** – If the software cannot connect, make sure the URL is correct. If it is, try changing **http://** to **https://** (or vice versa).

7. Select the **Coordinate system** to use. The EPSG code you select must match the coordinate system and zone of the job.
8. Configure the display settings:
  - To make the background more transparent, edit the value in the **Opacity** field.
  - Select the **Base layer** check box if you will use data from **more than one WMS** in the map and you want data from the selected WMS to be the bottom layer of the map. Data from other WMS services will be displayed on top of this layer.
  - Select the **Request transparent PNGs** check box to request transparent PNG files instead of JPG files from the WMS.

This is useful if you will use data from more than one WMS in the map and you want data from the selected WMS to appear on top of data from another WMS, or if you want higher resolution images from the WMS.

**NOTE** – PNG files are larger than JPG files and so will consume more data. Not all WMS services provide transparent PNG files.

9. Tap **Accept**.

The software returns to the **Web map service** screen, with the web map service you have just added selected.

10. Tap **Accept**.

The name of the web map service you have added is shown in the **Map files** tab.

11. To make the web map service data visible in the map, tap the WMS name. To show or hide layers from the WMS, tap the arrow next to the layer name and then tap the individual layers to show or hide them.

12. To return to the map, tap **Accept**.

To view WMS data in the map you may need to zoom to an appropriate level. Different levels of map detail may be shown at different zoom levels.

**TIP** – Internet connection issues can affect the display of WMS data. If the map does not show any WMS data, return to the **Web map service** screen and tap **Test** to check the software is able to connect to the configured server.

### To manage data filters

Use the **Filter** tab in the **Layer manager** screen to filter the points, lines, arcs, and polylines in the job by data type.



Select or clear the check boxes to make only the data you are interested in visible and selectable in the map. For example, you can filter by point types such as topo points, observed control points, or as-staked points. You can also filter lines, arcs, polylines, CAD linework, and points in linked files.

### To change which data types are visible

1. To open the **Layer manager**, do one of the following:
  - Tap  in the **Map** toolbar.
  - In the **Job properties** screen, tap the **Layer manager** button.
2. Select the **Filter** tab.

3. To automatically update the data shown in the Map as you make changes in the **Layer manager**, tap the **Auto update** softkey. A check mark on the **Auto update** softkey indicates **Auto update** is enabled.

**NOTE** – Changes made when **Auto update** is enabled are retained when you exit the **Layer manager** using either the **Accept** or **Esc** key.

4. Tap the point type or feature type to hide it. The check mark inside a square  next to the file name disappears.
5. Tap the point type or feature type again to show it. The check mark inside a square  next to the file name appears, indicating those points or features are visible and selectable.
6. To reset the data filters, use the softkeys below the map. Tap **None** to hide all point and feature types. Tap **All** to make all point and feature types visible.
7. Tap  to apply a finer filter. You can filter data by **Point name**, **Code**, **Descriptions** (if enabled) and **Note**. For more information, see [To filter data using wildcard search, page 190](#).
8. Tap **Accept**.

#### Available data types

You can choose to filter by the following feature types in the **Filter** tab:

- Topo points (GNSS) (measured in a GNSS survey)
- F1 Topo points (Conv.) (measured in a conventional survey)
- F2 Topo points (Conv.) (measured in a conventional survey)
- Mean turned angle
- As-staked points
- Keyed in points (normal)
- Keyed in points (control)
- Calibration points
- Cogo points (computed)
- Construction points

#### Job data

- Observed control points
- FastStatic points
- Base points
- Check points
- Offset points
- Intersection points
- Rapid points
- Laser points
- Resection points
- Continuous points
- Copied control points
- Copied construction points
- Copied normal points
- Copied as staked points
- Adjusted points
- Copied adjusted points
- Points on plane
- Points measured to surface
- Lines
- Arcs
- Polylines
- Linked file points
- CAD linework

## To manage feature layers

Use the **Features** tab in the **Layer manager** screen to manage which features are shown in the map by feature layer.

The feature layers shown in the **Features** tab are defined by the [Feature Library FXL file](#) linked to the job. Each feature layer contains a separate layer for each feature code defined for the layer when the Feature Library FXL file was created using the Feature Definition Manager in Survey Office.

Click the arrow next to the layer to view the codes defined for each layer and to show or hide features in the layer.

The **0** layer contains features that are not defined by pre-existing codes in the FXL file. This includes:

- Features that do not use a feature code. Uncoded features are in the **Uncoded** layer in the **0** layer.
- Features that use codes that are not defined in the FXL file, but were entered manually in the **Code** field when the point was measured. Manually coded features are in the code layers listed in the **0** layer.

**TIP** – When features use multiple codes, the feature is visible and/or selectable if any of the assigned codes is set to visible or selectable. For example, a point that uses "code1 code2" is selectable if "code2" is set to selectable and "code1" is set to hidden. Control codes are not shown in the **Features** tab.

## To change which coded features are visible



1. To open the **Layer manager**, do one of the following:
  - Tap  in the **Map** toolbar.
  - In the **Job properties** screen, tap the **Layer manager** button.
2. Select the **Features** tab.

To automatically update the data shown in the Map as you make changes in the **Layer manager**, tap the **Auto update** softkey. A check mark on the **Auto update** softkey indicates **Auto update** is enabled.

**NOTE** – Changes made when **Auto update** is enabled are retained when you exit the **Layer manager** using either the **Accept** or **Esc** key.

3. Tap a layer to hide it. The check mark inside a square  next to the layer name disappears.

4. To make features in a layer visible, tap the layer name. A check mark ✓ indicates features in the layer are visible.
5. To make layers selectable, tap the layer name again. A check mark inside a square  indicates features in the layer are selectable.
6. If the feature layer has multiple codes, by default all codes have the same setting as the layer. To make features using only some codes visible or selectable, tap the arrow next to the layer name and then tap each code once to hide it, or twice to make it visible but not selectable. Tap the code again to make it visible and selectable.

The icon next to the layer name indicates if some code are not visible  or not selectable .

7. To make all layers and codes selectable, tap the **All** softkey. To all feature-coded points, tap the **None** softkey.
8. Tap **Accept**.



## Map

The **Map** screen appears when you open the job, showing the last used view for the job.



Points, lines, arcs, and polylines from the job database are shown in the map in black. Currently selected items are shown in blue.

The map also shows data from other data files that have been added to the job and made visible in the map. These data files may contain points, lines, arcs, polylines, and other map items such as alignments and surfaces that are not in the current job that you want to be able to view and select in the map. See [Supported map files](#). Points, lines, arcs, and polylines in other map files are shown in the colors defined in the file. Feature code processing colors appear in the color defined in the feature library, except line features that are coded as white are drawn in black. See [Survey Office feature libraries, page 96](#).

The map shows only the linked files that are set to visible. To change the files or layers within files that are visible, or to link more files to the map, tap  in the map toolbar to open the **Layer manager** and select the **Map files** tab. See [To manage map files, page 118](#).



To view the map extents, tap . To create an area of interest, tap and hold . For more information, see [Map toolbar](#).

The map provides different ways to view your data. The default **Plan** view shows the map in two dimensions. All other map views are three-dimensional views. Tap  in the map toolbar to select a different view. You can rotate 3D data to view the data from different sides, which is useful when

viewing a BIM model in an IFC file. Viewing data in 3D is also useful in a more traditional survey for looking at elevation changes and detecting antenna height errors. To rotate data in the map, tap  and then tap the map and drag to rotate the view. The  icon in the center of the map indicates the point of orbit.

To change the information that is shown in the map, such as labels and symbols, tap . See [Map settings, page 139](#).

When you start a survey, the map shows the location of the surveying equipment in use, where:

- The current orientation of a conventional instrument is shown by a dotted line extending from the instrument to the end of the screen.
- The current location of the prism is displayed as .
- The current position of the GNSS antenna is displayed as .

You can access most software features from the map. Software forms appear next to the map so that you can still view the map and select features in the map when the form is open.

When no features are selected, tap **Measure** to open the **Measure topo** or **Measure point** form and select the measurement method.

To create line, arc, and polygon features in the map as you measure points, or by drawing line and arc features using feature coded points already in the job, tap and hold in the map and enable the **CAD toolbar**. See [CAD toolbar](#).

When features are selected in the map, tap **Review** to review their details, tap **Stakeout** to stake them out, or tap and hold in the map to access other functions. Alternatively, tap  to access other software functions from the menu or the **Favorites** list.

### Supported map files

Map files are files that contain points, lines, arcs, polylines, and other map items such as alignments and surfaces that are not in the current database that you want to be able to view and select in the map.

Supported map file types are:

- AutoCAD (ASCII) files (.dxf)
- ESRI Shapefiles (.shp)
- LandXML files (.xml)
- TrimBIM (Trimble BIM files) (.trb)
- IFC (Industry Foundation Classes) files (.ifc, .ifczip)



- Surfaces or digital terrain models (.dtm .ttm .xml, .dxf)
- Alignment files (.rxl)
- RXL roads (.rxl)
- GENIO roads (.inp, .crd, .mos)
- 12D Model files (.12da) – supported only in Roads
- Background images from georeferenced image files or a web map server

For information specific to these file types, refer to the appropriate topic.



#### DXF, Shape and LandXML files

DXF, Shape and LandXML files contain survey or engineering design data that has been created from various office software packages.

- A **DXF file** is a 2D or 3D vector graphic file format generated from CAD software such as AutoDesk. DXF stands for Drawing Exchange Format.
- A **Shapefile** is an ESRI vector data storage format for storing geographic features as points, lines, or polygons as well as attribute information.
- A **LandXML file** is an XML file format for civil engineering design and survey measurement data such as points, surfaces, parcels, pipe network data and alignments.

The rest of the this topic applies equally to DXF, Shape, and LandXML files, unless otherwise stated.

#### Viewing DXF, Shape and LandXML files in the map

To display DXF, Shape, or LandXML files in the map, tap  in the map toolbar to open the **Layer manager** and select the **Map files** tab. Tap the file once to make it visible ( ✓ ), and tap it again to make items in the file selectable (). To add files from a different location to the project folder, tap **Add**. For more information, see [To manage map files, page 118](#).

These types of files typically contain layers. To make only some layers visible or selectable, in the **Map files** tab, tap the arrow next to the file name and then tap each layer once to hide it, or twice to make it visible but not selectable. Tap the layer again to make it visible and selectable.

For a complete list of displayable and selectable items in DXF, Shape and LandXML files, see [Displayable and selectable entities, page 132](#) below.

Triangular 3D faces in a DXF file and triangulated DTMs in a LandXML file can be used as surfaces in Origin. See [DTMs and surfaces](#).

### Map settings for DXF, Shape and LandXML files

The Origin software provides settings for controlling the display of the data in DXF, Shape, and LandXML files. To configure these settings, tap  in the map toolbar, select **Settings** and configure the setting in the **Map data controls** group.

**TIP** – Line features that are coded as white in a DXF file are drawn in black in Origin.

#### To explode polylines

To explode polylines contained in the file into individual line and arc segments, select the **Explode polylines (DXF, Shape & LandXML)** check box. Each segment in an exploded polyline is given a unique name, based on the polyline name and a segment number.

#### To create nodes

To create points at the ends of lines and arcs and at all points along a polyline, select the **Create nodes (DXF, Shape & LandXML)** check box. The created points can then be selected for stakeout or Cogo calculations.

This option applies to DXF files, Shapefiles, and LandXML parcels (polylines).

This option also creates points at the center of circle and arc elements in DXF files, but creating a point at the center of a DXF arc element does not apply to arc elements that are part of a polyline.

**NOTE** – *Because Shapefiles do not support arcs, arcs are often represented as a series of short lines resulting in a large number of points. Performance may be impacted when **Create nodes** is selected.*

**TIP** – Surpac background files already have the node points available. Clearing the **Create nodes** check box does not hide these node points.

#### To specify the null elevation

Some applications use a value such as -9999.999 to represent null. For the Origin software to correctly treat this value as null, you must enter the value that represents null in the DXF file in the **Null elevation (DXF only)** field. Values are considered to be null if they are less than or equal to the null elevation value. For example, if the null elevation is -9999, then -9999.999 is also considered to be null.

Only grid coordinates are displayed. If you have not defined a projection, only points stored as grid coordinates appear. Grid (local) coordinates cannot be displayed if the input transformation was not defined. See [Transformations, page 261](#).



If the **Grid coords** field in the [Cogo settings](#) screen is set to Increase South-West or Increase South-East, the map display is rotated by 180° such that increasing south coordinates are displayed up the screen.

### To display labels

To show or hide names, codes, and elevations for items in DXF, Shape, and LandXML files, tap the appropriate **Display** check box(es) in the **Map data controls** group.

The software shows these extra labels only when the file is set to selectable in the **Layer manager**. If the file is only set to visible, the extra labels are not shown. See [To manage map files, page 118](#).

### Working with DXF, Shape and LandXML files

To rotate the data in the map, tap  and then tap the map and drag to rotate the view. The  icon in the center of the map indicates the point of orbit.

To review attribute information for items in a DXF file, Shapefile or LandXML file that have feature types associated with them, select the items in the map and then tap **Review**. If you selected more than one item, select it from the list and tap **Details**.

From the map, you can select items in the DXF, Shape, or LandXML files and then use them in other software functions, for example to perform a Cogo calculation, create a surface, or stakeout. For more information, see [Displayable and selectable entities, page 132](#) below.

You can export data from the job as DXF files or Shapefiles. See [To export data from the job](#).

### Staking

You can select items (points, lines and arcs) in DXF, Shape, or LandXML files and stake them out.

1. Tap  in the map toolbar and select the **Map files** tab. Make sure the layers containing the items to stake are visible and selectable.
2. In the map, tap the item to select it. For lines, tap near the end of the line to select the start of the line.
3. Tap **Stakeout** or press **Enter** on the controller to start stakeout.
4. To save the DXF, Shape, or LandXML file attributes for the selected item with the as-staked point, tap **Options** in the **Stake out** screen and set the **As-staked code** to **Design file attributes**. See [As-staked point details, page 511](#).

To stake an alignment from a LandXML file, select the alignment in the map and tap **Stakeout**. When prompted, store the alignment as an RXL alignment and then select the RXL alignment to stake.

You can also stake pipe network data from a LandXML file. Pipe network LandXML files contain pipes and structure (manhole) data. When reviewing a pipe or structure (manhole), the LandXML data can include data such as multiple inverts, pipe length, slope and diameter. When staking a manhole with multiple inverts set the **Staked deltas format** to **Stake manhole inverts** to have Origin read the

multiple inverts from the LandXML file and provide extra design elevations with their associated vertical offsets and updated cut/fill values on the **Confirm staked deltas** screen.

### Displayable and selectable entities

For DXF, Shape, and LandXML files that contain layers, a name is generated for every selectable feature in the file. A code can be generated for every selectable feature within the file. This is derived from the attributes stored file; often, it is the name, code, and attributes of features in the original file.

For Shapefiles, the name is the first five characters of the Shapefile name, followed by a file index number, then a space and then the line number in the Shapefile where this feature is defined.

For DXF files, the name is the first 8 characters of the layer name, followed by a space and then the line number of the feature in the DXF file. For DXF files from Survey Office the item name, where present, is used.

You can review a selectable feature in the map to find the file and layer name.

### DXF files

Displayable and selectable DXF entities:

- ARC, CIRCLE, INSERT, LINE, POINT, POLYLINE, LWPOLYLINE.

Display only DXF entities:

- 3D FACE, SPLINE, SOLID, ATTRIB, BLOCK ATTRIB, TEXT, MTEXT, HATCH.
- Control characters: C – diameter symbol, D – degree symbol, P – plus/minus symbol, % – percentage symbol.

Extrusion arcs contained in a DXF file are displayed correctly in the map, but cannot be made active. Extrusion arcs form an ellipse in plan view and the staking of ellipses is not supported.

To show hatched polygons, tap  in the map toolbar, select **Settings** and select the **Hatch polygons** check box.

### Shapefiles

Supported Shapefile entities:

- Null shape, Point, PolyLine, Polygon, MultiPoint, PointZ, PolyLineZ, PolygonZ, MultiPointZ, PointM, PolyLineM, PolygonM, MultiPointM, MultiPatch, Hatching.

To see attribute information for Shapefile entities, the Shapefile must have an associated .dbf file.

To show hatched polygons, tap  in the map toolbar, select **Settings** and select the **Hatch polygons** check box.

## LandXML files

Supported LandXML entities:

- Points (CgPoint elements), Lines (Parcel and PlanFeature elements), Surfaces.
- Only points, lines, surfaces, and alignments that are contained in elements directly under the primary LandXML element are supported.

If there are overlapping surfaces on the map, the interpolated elevation will be that of the first surface returning a non-null elevation (the surface with the first name alphabetically).

## BIM and IFC models

A BIM model is a 3D model of a building or other built asset such as a bridge, road, or pipeline. BIM models are used in the planning, design, construction, and maintenance of the built asset.



Origin supports the following BIM file types:

- TrimBIM (\*.trb) files are BIM models in a Trimble file format that is a smaller, more efficient alternative to IFC.
- IFC files are Industry Foundation Class files. They provide a BIM model that can be used for surveying fieldwork including stakeout, cogo calculations and measuring points. Origin supports IFC files in the .ifc or .ifczip file format.

**NOTE** - Origin does not support BIM models when running on an Android device.

IFC file settings in Origin apply equally to TrimBIM files.

## Viewing IFC models in the map



To display an IFC model in the map, tap  in the map toolbar to open the **Layer manager** and select the **Map files** tab. Tap the IFC file once to make it visible (✓), and tap it again to make items in the file selectable (). For more information, see [To manage map files, page 118](#).

To make only some layers visible or selectable, tap the arrow next to the file name and then tap each layer once to hide it, or twice to make it visible but not selectable. Tap the layer again to make it visible and selectable. Layers are named based on the IFCPRESENTATIONLAYERASSIGNMENT attribute in the IFC file.

To see more clearly inside a model, use the **Limit box** to exclude parts of the model such as floors or exterior walls. See [Limit box, page 170](#).

Objects in IFC files can be displayed as solid objects with 100% opacity; you can reduce the opacity to make the object more transparent. To make the object more transparent, tap  and select **Settings**. In the **IFC** group box, select an **Opacity** value less than 100%.

You can also display the model as a wireframe rather than as a solid object. Displaying as a wireframe enables you to see more detail in the IFC model and makes it easier to select the correct points or lines for stakeout. To view the model as a wireframe, tap  and select **Settings**. In the **IFC** group box, select **Wireframe** in the **Display** field. If you frequently switch between wireframe and solid views, you can [configure a function key on the controller](#) to switch between the wireframe and solid view of the IFC model. For more information, see [Map settings, page 139](#).

To rotate the BIM in the map, tap  and then tap the map and drag to rotate the view. The  icon in the center of the map indicates the point of orbit.

**NOTE** – *To improve performance, the map may not display very small items or details until the map is zoomed in to an appropriate zoom level.*

### Working with IFC models

You can select items in the IFC model from the map and then use them in other software functions, for example to perform a Cogo calculation, create a surface, or stake out. Tap an item in the IFC file to select it. You cannot drag a box around multiple items in an IFC file to select them.

You can select vertices, edges, curved edges (polyedges, such as the rim of a cylinder), grid lines, or surfaces.

**NOTE** – *To select a surface the IFC model must be shown in the map as a solid object, not as a wireframe.*

You can choose whether selecting surfaces in the map selects **Individual faces** or selects the **Whole object**. To change the **Surface selection mode**, tap  and select **Settings**. In the **IFC** group box, select your preferred option from the **Surface selection mode** field. See [Map settings, page 139](#).

For example:

- When measuring to the top of a concrete slab, select the **Individual faces** option and then select the top surface of the slab to ensure that when measuring to the surface the software will measure only to the top surface rather than to the closest point of the whole concrete slab.
- When performing a surface inspection of a square pillar, select the **Whole object** option so that when you tap the pillar all 6 faces of the pillar are selected and used in the inspection.

To select all surfaces in the map, tap and hold on the map and choose **Select all surfaces**. Origin selects every selectable surface in all BIM or IFC files that are currently set to selectable in the **Layer manager**. If the **Surface selection mode** is set to **Individual faces**, then each face is selected as separate surfaces. If the the **Surface selection mode** is set to **Whole object**, then all surfaces in the map are selected as a whole object surface.

To measure to a surface in an IFC model, select the surface in the map and then select **Measure to selected surface** from the tap and hold menu. This is useful in determining the perpendicular distance from the physical surface to the design.

To review attribute information for vertices, edges, and surfaces in an IFC file, select the items in the map and then tap **Review**. If you selected more than one item, select it from the list and tap **Details**.



### Cogo calculations using IFC files

To compute the center point of a surface in an IFC model, select the surface in the map and then select **Compute center point** from the tap and hold menu. This is useful to find the center point of a bolt or cylinder so you can then stake it out. See [Compute center point](#).

To compute the centerline of any tube-like item in an IFC model, such as a pipe or cylinder, select it in the map and then select **Compute centerline** from the tap and hold menu. The software computes a polyline that runs along the center of the item. See [Compute centerline](#).

### Staking from IFC

You can stake vertices and stake them as points or select edges, curved edges, or grid lines and stake them as lines directly from IFC files.

1. Tap  in the map toolbar to open the **Layer manager** and select the **Map files** tab. Tap the IFC file once to make it visible ( ✓ ), and tap it again to make items in the file selectable ().
2. Tap the items in the map to select them. You must tap each point or line in the IFC model you want to select.
3. Tap **Stakeout** or press **Enter** on the controller keypad.
4. To save the IFC file attributes for the selected item with the as-staked point, tap **Options** in the **Stake out** screen and set the **As-staked code** to **Design file attributes**. See [As-staked point details, page 511](#).

### To create points from vertices in an IFC file

If required, you can create points from vertices in the file and save the points to the job.



1. Select the vertex (or vertices) in the map.
2. Tap and hold in the map and select **Create point**.
3. For each vertex, enter the **Point name**.

4. If required, enter the code for the point in the **Code** field.
5. Tap **Store**.



### Alignments

Alignments can be defined in the Origin Roads or Survey Office software, or a number of third-party design packages including Autodesk AutoCAD Land Desktop, AutoCAD Civil 3D, Bentley InRoads, and Bentley GEOPAK. Alignments are stored as RXL files and can be easily shared between jobs and with other controllers.

### Viewing alignments in the map

To display an RXL file in the map, tap  in the map toolbar to open the **Layer manager** and select the **Map files** tab. Tap the RXL file once to make it visible (✓), and tap it again to make items in the file selectable ().

To change the labels shown in the map, for example to view alignment station values, tap  and select **Settings** and then modify the options in the **Display** group box.

To rotate the alignment, tap  and then tap the map and drag to rotate the view. The  icon in the center of the map indicates the point of orbit.

### Working with alignments

From the map, you can select points along the alignment and then use them in other software functions, for example to perform a Cogo calculation or create a surface.

To include templates and superelevation and widening records in the alignment or road, you must use the Origin Roadssoftware.

### Staking out using alignments

When you select the alignment in the map there are various stakeout options available, including staking out to the alignment and staking out the side slope from the alignment. You can select stations on the alignment to stake out, or stake out a station at a skew offset from the alignment. See [To stake out an alignment](#).

### DTMs and surfaces

You can view electronic representations of a topographical surface or digital terrain model (DTM) in the map. The Origin software supports such surfaces in the following file formats:



- gridded terrain models (.dtm)
- triangulated terrain models (.ttm)





- triangular 3D faces in a DXF file (.dxf)
- triangulated DTMs in a LandXML file (.xml)

**NOTE** – You must define a projection and datum transformation before you use a DTM in a GNSS or conventional survey.

### Viewing DTMs in the map

To display a DTM in the map, tap  in the map toolbar to open the **Layer manager** and select the **Map files** tab. Tap the DTM file once to make it visible ( ✓ ), and tap it again to make points in the file selectable (). If the file is a DXF or LandXML file, tap the arrow next to the file name and then tap the appropriate layer once to make it visible and again to make it selectable.

When a surface is enabled in the map, a color gradient shows the elevation changes. To disable the color gradient and show only an outline of the surface, tap **Options** and then clear the **Display color gradient** check box.

To rotate the surface in the map, tap  and then tap the map and drag to rotate the view. The  icon in the center of the map indicates the point of orbit.

### Working with DTMs

From the map, you can select points and lines in the surface and then use them in other software functions, for example to perform a Cogo calculation, create a surface, or stakeout.

If you have three or more 3D points in the job, you can create a surface and store it as a triangulated terrain model (TTM) file in the current project folder. You can then use the surface to calculate a volume. See [To create a surface](#).

During a survey, you can use the **Measure to surface** measurement method to calculate and store the closest distance from the measured point to the selected surface model.

### Staking out using DTMs

You can stake out points on a DTM or you can stake out points, lines, arcs, or alignments relative to the DTM. See [To stake out a DTM](#) and [To show the cut/fill to a DTM during stakeout](#).

You can view the cut and fill relative to the DTM, and specify an offset to raise or lower the DTM. The offset can be applied vertical or perpendicular to the DTM.

1. Transfer a DTM file to the appropriate [project folder](#) on the controller.
2. Make sure the file containing the alignment is visible and selectable in the map.

If it is available, your current position, the DTM elevation, and the distance above (cut) or below (fill) the DTM appear in the map screen.

3. Tap **Stakeout**.
4. Tap the **Options** softkey.
5. If required, in the **Offset to DTM** field, specify an offset to the DTM. Tap  and select whether the offset is to be applied vertical or perpendicular to the DTM. The **V.Dist DTM** value is to the offset position. The offset can be configured in **Options** when you select the DTM file. When defined, the offset also appears in the Map.
6. Tap **Accept**.
7. To change the target or antenna height, tap the target or antenna icon in the status bar.

If the target or antenna height have not been defined, the elevation and cut/fill will be null (?).

**NOTE** - When the offset is applied perpendicular to the DTM, the cut/fill value is computed using the following steps:

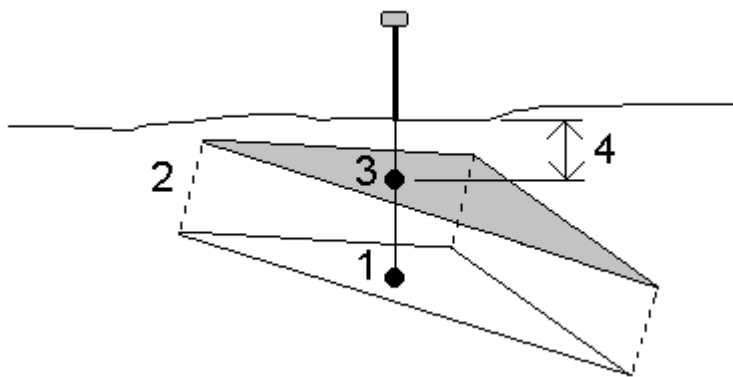

1. Determine the triangle that the current position lies on (1).
2. Offset that triangle at a right angle by the specified offset value (2) to define a new triangle.
3. Compute the elevation of the same position on the new triangle (3).
4. Compute the cut/fill value from the computed elevation to the staked position (4).

#### Map background files

Map backgrounds provide context for your data. Use the **Layer manager** to add background image files to the map.

If the controller is connected to the Internet, you can [use an online map provided by a web map service \(WMS\)](#), instead of adding your own background images.

### To add background image files to the map

To display a background image in the map, tap  in the map toolbar to open the **Layer manager** and select the **Map files** tab. Tap the file once to make it visible. A single check mark  indicates this file is visible in the map. Tap the file again if you want to hide the image from the map. To add files from a different location to the project folder, tap **Browse**.

### Supported background image files

Background image files that you add to the project must have an associated world file to appear in the map. The following image file types and associated world files are supported:

Image files	World files
GeoTIFF	N/A
TIFF (.tif)	.wld .tfw
Bitmap (.bmp)	.wld .bpw .bmpw
JPG	.wld .jgw .jpgw jpegw
PNG (.png)	.wld .pgw .pngw

**NOTE** - Only 24-bit color JPG files are supported; pure grayscale JPG files are not supported.

TIFF files are generally much more efficient in their use of program memory than other background image formats such as BMP, JPG or PNG. This makes it possible to load TIFF files with file sizes of 100 MB or more, while using only a few MB of program memory. However, if the TIFF file is one large tile then this means the entire file will be loaded into the program memory which will affect controller performance.

### Map settings

Use the **Map** settings to change the appearance of information shown in the **Map** screen, and to configure map behavior.

To open the **Map** settings, tap  and then select **Settings**. The available settings depend on the connected instrument.

To change the information that is shown in the map, such as labels and symbols, tap  and then select an option from the list.

**NOTE** - The following settings are job-specific and must be set in the map for each job: vertical exaggeration scale, groundplane, and surface options. Other settings apply to all jobs.

## Display options

To change the information shown in the map, tap the check box(es) to show or hide:

- name labels next to points
- code labels next to points
- elevations
- point symbols for each point
- points from the stakeout list
- hatched polygons in a background file (including DXF files or Shapefiles)

**NOTE** – To display labels and elevations for points in data files such as DXF, RXL, or LandXML, use the check boxes in the **Map data controls** group (see below).

### Label color

To change the color used for labels, select it from the **Label color** list.

### Lighting effects

The **Lighting effects** check box controls whether shading and refraction are automatically applied to surfaces. Lighting effects give more graphical depth to surfaces, but can introduce shading or shine effects in small areas on some surfaces.

### Monochrome map

To display items in map files in grayscale, select the **Monochrome map** check box.

### Abbreviate labels

By default, point name and code labels are abbreviated to show only the first 16 characters. To display the complete label, clear the **Abbreviate labels** check box.

## Map behavior

### Automatic pan to current position

If the current position is off-screen and the previous position was on-screen, select the **Automatic pan to current position** check box to automatically center the map on the current position. If no current position is available, for example during a station setup, the map does not pan.

### Vertical exaggeration

To emphasize vertical features which might be too small to identify relative to the horizontal scale, enter a value larger than 1.00 in the **Vertical exaggeration** field. The default setting of 1.00 indicates that the horizontal and vertical scales are identical, which gives a true representation of the data.

## Map orientation

Select whether the plan view of the map is oriented to **North** or to the **Reference azimuth**.

### Reference azimuth

The **Reference azimuth** field shows the value entered in the **Reference azimuth** field of the **Cogo settings** screen of the job properties (see [Cogo settings, page 99](#)). Editing the **Reference azimuth** field in the **Map settings** screen updates the **Reference azimuth** field in the **Cogo settings** screen.

**NOTE** – 3D map views are always oriented to the **Reference azimuth**. The **Reference azimuth** is also used by the map **Limit box** to align the Limit box surfaces with map data. See [Limit box, page 170](#).

To find the reference azimuth value, tap the line in the map you want to orient the map to, and then tap **Review**. In the review pane, if required select the line from the list and tap **Details**. Copy the value in the **Azimuth** field and then tap  in the Map toolbar and select **Settings**, and paste the **Azimuth** value into the **Reference azimuth** field.

### Map data controls

To explode polylines contained in DXF, Shape, and LandXML files into individual line and arc segments, select the **Explode polylines (DXF, Shape & LandXML)** check box.

To create points at the ends of lines and arcs and at all points along a polyline, or at the center of DXF circle and arc elements, select the **Create nodes (DXF, Shape & LandXML)** check box. The created points can then be selected for stakeout or Cogo calculations.

Some applications use a value such as -9999.999 to represent null. For the Origin software to correctly treat this value as null, enter the correct value in the **Null elevation (DXF only)** field.

To show or hide text entities in a DXF file, tap the **Display DXF text** check box. Disabling text entity display in a DXF file that includes a lot of text entities can improve map performance.

To show or hide names, codes, and elevations for entities in DXF, Shape, and LandXML files, tap the appropriate **Display** check box(es) in the **Map data controls** group. These check boxes are provided separately to the check boxes for other data files to give you more control over which labels are shown.

To show or hide station values for RXL alignments, RXL roads, LandXML roads or GENIO roads, select the **Display station values** check box.

For more information about any of the options in the **Map data controls** group box, see [DXF, Shape and LandXML files](#).

### Groundplane options

To configure the groundplane displayed in the map, select the **Display groundplane** check box and then enter the elevation of the groundplane.

The groundplane elevation is used as a visual reference when viewing the map in 3D. It is not used in calculations.

### Surface options

#### Surface (TTM, DXF and LandXML)

To change how surfaces appear in the map, select one of the following:

- Color gradient
- Shaded
- Triangles
- Color gradient + triangles
- Outline

Enter a value in the **Offset to DTM (Vertical)** field to raise or lower the surface when viewing from the map.

To modify a surface, for example to delete some triangles, see [To create a surface](#).

#### Road surface

To change how surface appears in the map, select one of the following:

- Color gradient
- Shaded
- Outline

### IFC

Use the **Display** field to change how entities in an IFC file are displayed in the map:

- Select **Solid** to view entities as solid objects with 100% opacity. To make the object more transparent, select an **Opacity** value less than 100%.
- Select **Wireframe** to view the edges of the object. White lines in the IFC file are shown in black when the **Wireframe** option is selected.

**NOTE** - To select a surface the IFC model must be shown in the map as a solid object, not as a wireframe.

Use the **Surface selection mode** field to choose what is selected when you select surfaces in the map:

- Select the **Individual faces** option to select only a single face of the object at a time.  
If you select multiple faces, each face is treated as a separate surface.
- Select the **Whole object** option to select the whole object as a single surface.  
Any hidden parts of the object are also selected, such as parts that are used to join the object to another object.

For example:

- When measuring to the top of a concrete slab, select the **Individual faces** option and then select the top face of the slab to ensure that when measuring to the surface the software will measure only to the top face rather than to the closest point of the whole concrete slab.
- When performing a surface inspection of a square pillar, select the **Whole object** option so that when you tap the pillar all 6 faces of the pillar are selected and used in the inspection.

Software functions that apply to surfaces can be used whether the **Surface selection mode** is set to **Individual faces** or **Whole object**.

**TIP** – Items selected in the map remain selected when you change the **Surface selection mode**. However, if you set the **Surface selection mode** to **Whole object**, then selecting an object first deselects any individual faces of the object that are already selected.

### Selecting items in the map

You can select items such as points, lines, arcs or polylines from all supported map file types, including DXF, IFC, RXL, and DTM files. You cannot select points in background images displayed in the map.

**NOTE** – To select items from a linked map file, the map file or the feature layer within the linked map file must be made selectable. See [To manage map files, page 118](#).

### To select items in the map

- Tap the required items in the map. If there are several items close together, a list of items appears. Select the items as required and then tap **OK** to return to the map.

**TIP** – When selecting a line, arc, or polyline to stakeout, tap near the end of the line, arc, or polyline that you want to designate as the start. Arrows are then drawn on the item to indicate

the direction. If the direction is not correct, tap the item to deselect it and then tap it at the correct end to reselect the direction required.

**NOTE** – *Offset directions are not swapped when the line direction is reversed. The direction of RXL alignment and road files is defined when they are created, and cannot be changed.*

- Drag a box around the items you want to select.

When multiple items are selected in this way they are typically sorted in the order in which they are stored in the database.

If the order of the items in the selection is important, you should select them one by one.

- Tap ► next to an item name field to select the item from the list of selected map items. Only items of that type are shown.
- For any field where you need to select a point, you can tap the point in the map to select it. For some Cogo and Stakeout functions, when you select items from the map and then select the function, the selected items are automatically entered into the appropriate fields.

#### To deselect items from the map

- Tap the selected item to deselect it. If there is more than one item within the highlighted area, a list of items within this area appears. Deselect the items as required. Tap **OK** to return to the map.
- Tap and hold in the map and select **List selection**. A list of the selected items appears. Deselect the items as required.
- To clear the selection, double-tap an empty part of the map. Alternatively, tap and hold in the map and select **Clear selection**.

#### Working with the selected items

Once you have selected items in the map, tap **Review** to review details of the selected items or tap **Stakeout** to stake them out. You can also double-tap an item in the map to stake it out.









If more than one item is selected, the items are added to the **Stake out items** list, from where you can select them for stakeout.







Alternatively, tap and hold in the map and select the required function. See [Map tap and hold options, page 174](#).









If there are no items selected, tap **Measure** to measure the current position.

## Map toolbar

Button	Function
<b>Select</b> 	<p>Tap  to select features.</p> <p>Tap the features in the map to select, or drag to create a box around the features you want to select. For more information, see <a href="#">Selecting items in the map, page 143</a>.</p> <p>To clear the current selection, double-tap an empty part of the map.</p>
<b>Pan</b> 	<p>Tap  to activate Pan mode. Tap an area of the map to center on, or tap and drag the map area to where you want to reposition the map.</p> <p>If you are using a controller that has arrow keys, you can use the arrow keys to pan even when the map is not in Pan mode.</p> <p>Alternatively, place two fingers on the screen and slide in the desired direction to move the view even when the map is not in Pan mode.</p> <p>To pan to a point in the map, tap  in the map toolbar and select <b>Pan to point</b>. Enter a point name and scale value.</p> <p>To center the map at the current position, tap  in the map toolbar and select <b>Pan to here</b>. For more options, such as to change the scale at which to zoom, select <b>Pan to point</b> and configure your settings and then tap the <b>Here</b> softkey in the <b>Pan to point</b> screen.</p>
<b>Zoom</b> 	<p>Tap  or  to zoom in or out one zoom level at a time.</p> <p>Alternatively, place two fingers on the screen and stretch out to zoom in on the center of the map or pinch in to zoom out. Drag one finger across the screen to pan.</p> <p>To zoom to an area of interest, tap and hold the button and then drag a box around the area of interest.</p>

Button	Function
<p><b>Zoom extents</b></p> 	<p>Tap  to zoom to the map extents.</p> <p>You can configure the zoom extents so that part of the map is excluded. This is useful when, for example, you want to exclude a base station position that is several kilometers away. To do this, use the map pan and zoom tools so that the map shows the area of interest and then tap and hold <b>Zoom extents</b> and select <b>Set user zoom extent</b>. This is now the map view shown when you tap <b>Zoom extents</b>. To clear the custom view, tap and hold <b>Zoom extents</b> and select <b>Clear user zoom extent</b>.</p> <p>To create an area of interest, tap and hold <b>Zoom extents</b> and select <b>Set area of interest</b>. This is useful when, for example, you have a large job site and you want to view only the part you are currently working in. To return to this view, tap and hold <b>Zoom extents</b> and select <b>View area of interest</b>.</p> <p><i><b>NOTE</b> – The area of interest commands are available only when the map is in Plan view. If they are not available, tap  and select <b>Plan</b>.</i></p> <p>When zooming it is useful to be able to return to the previous view. Tap and hold <b>Zoom extents</b> and select <b>Zoom to previous</b>, or press <b>Ctrl + Z</b>.</p> <p><i><b>NOTE</b> – The current position of the GNSS antenna is not considered part of the map extents unless it is currently being used for GPS search.</i></p>
<p><b>Orbit</b></p> 	<p>Tap  to orbit the data around an axis. Tap the map and then drag to rotate the view.</p> <p>The NE axes icon rotates accordingly, to show the orientation of the North and East elevations. The  icon in the center of the map indicates the point of orbit.</p>
<p><b>Predefined view</b></p> 	<p>Tap <b>Predefined view</b> to select a predefined view of the map.</p> <p>Tap the button and then select <b>Plan, Top, Front, Back, Left, Right</b> or <b>Iso</b>. <b>Plan</b> view shows the map in two dimensions; the other views are three-dimensional views.</p> <p>When in <b>Plan</b> view, additional options are available from the tap and hold menu. These options are not available in the other predefined views.</p> <p>The <b>Iso</b> view shows an isometric view of the data where each angle is 60 degrees. Select <b>Iso</b> again to rotate the view by 90 degrees.</p>

Button	Function
<b>Layer manager</b> 	Tap  to link files to the job or to change which points and features are visible and selectable in the map. See <a href="#">Layer manager, page 115</a> .
<b>More</b> 	<p>Tap  and then select the appropriate menu item.</p> <p>To change the appearance of information shown in the <b>Map</b> screen, and to configure map behavior, tap  and then select <b>Settings</b>. See <a href="#">Map settings, page 139</a>.</p> <p>To pan to a specific point or to pan to your current location, tap  and select the appropriate option.</p>

### CAD toolbar

The CAD toolbar enables you to easily use **control codes** to create line, arc, and polygon features in the map as you measure points, or by drawing line and arc features using feature coded points already in the job.

To create features as you measure, select the feature code for the point and then select the appropriate control code from the CAD toolbar. See [To create features using control codes in Measure codes](#).

To draw line and arc features between existing points, select the appropriate control code from the CAD toolbar and then select the points in the map. See [To draw features from existing points](#).

#### **NOTE -**

- *To create features, the feature library must contain **feature codes defined as lines** for the features you want to create, **and defined control codes** for the required action to create the feature geometry, such as starting or ending a new join sequence. See [How control codes work, page 150](#).*
- *The CAD toolbar can only be used to draw or create lines between points in the job. It cannot be used to draw or create lines between points in linked CSV files or map files such as DXF.*

To display the toolbar, tap  on the map toolbar and then select **CAD toolbar**. The CAD toolbar is only available when you are using General Survey.

### CAD toolbar modes

The CAD toolbar works in two modes: **Measure mode** and **Drawing mode**. The tools available on the CAD toolbar depend on whether the CAD toolbar is in **Measure mode** or **Drawing mode**.

If a **Measure** form is not open, the CAD toolbar opens in **Drawing mode**. You must be in a survey and have a **Measure** form open to use **Measure mode**. **Measure** forms are **Measure points**, **Measure topo**, or **Measure codes**. When you open a **Measure** form, the CAD toolbar automatically switches to **Measure mode**.

To switch between modes, tap  and then select the required mode.

**TIP** – If lines created using the CAD toolbar are not visible in the map, tap  and select **Filter**. Tap **All** or tap the **CAD linework** list item so that a check mark appears next to it.





### CAD toolbar in Measure mode











Use the CAD toolbar in Measure mode to create line and polygon features built from points as you measure them. To use Measure mode you must have started a survey and have a **Measure** form open.

In Measure mode, the CAD toolbar displays **8 configurable buttons** for control code functions.

To swap one of the control codes on the toolbar with another one not already assigned, tap and hold any control code on the toolbar and then select the new control code from the list. The selected control code replaces the one you selected on the toolbar.

The following control codes can be selected and added to the CAD toolbar:

Button	Control code
	Start join sequence
	End join sequence
	Start tangential arc
	End tangential arc
	Start non-tangential arc







Button	Control code
	End non-tangential arc
	Start smooth curve
	End smooth curve
	Start rectangle
	Start circle (center)
	Start circle (edge)
	Join to first (same code)
	Join to named point
	Skip join
	Horizontal/vertical offset

For more information on using these tools, see:

- [To create features using control codes in Measure codes, page 152](#)
- [Quick reference: CAD toolbar with Measure codes, page 161](#)
- [Quick reference: CAD toolbar with Measure points or Measure topo, page 165](#)

## CAD toolbar in Drawing mode

In Drawing mode, the CAD toolbar has the following buttons:

Button	Function
	Draw a line.
	Draw an arc.
	Start a new join sequence.
	Start second arc of a back-to-back arc.
	End join sequence
	Delete a line or arc feature you have created using the CAD toolbar.
	Tap to switch to Measure mode. Measure mode is available only when you have started a survey.

### How control codes work



Control codes defined in the feature library are used to construct line or polygon features using points. Points that have the same line or polygon feature code assigned to them are joined by lines. Origin does not fill polygons.

To create features, the feature library must contain codes defined as lines for the features you want to create, and control codes for the required action to create the feature geometry, such as starting or ending a new join sequence. The example codes in this topic are found in the **GlobalFeatures.fxl** which is provided with Survey Office.

**Start join sequence** control codes start lines, and **End join sequence** control codes end lines. You can use one or the other, or both, depending on the situation or workflow you prefer as there is flexibility in how you use them. For example, you can start lines without a control code, but to start the next line of the same feature code type you can use either the **End join sequence** control code on the previous/last measurement, or use the **Start join sequence** control code on the first point of the new line.

For example, to survey the centerline of a road, the feature library must contain a road centerline (**RCL**) feature code defined as a **Line** feature type. To create the centerline feature, before measuring the first point in **Measure codes** select the **RCL** feature code and then tap the start join



sequence button  on the CAD toolbar. All subsequent points with that are assigned the **RCL** feature code are added to the line.

You can assign multiple feature codes and control codes to a single point. When assigning more than one feature code, the simplest way to select multiple feature codes is to use the **Multi-code** button  in the **Measure codes** form. First tap , and then select the feature code and the control code(s) to apply.



#### To draw features from existing points

Use the CAD toolbar in Drawing mode to select existing points in the map and create coded linework between them. You can draw lines, arcs, and back-to-back arcs. You can also delete linework that you have created using the CAD toolbar.

#### To draw a line feature

1. Tap the **Draw line** button .
2. If required, tap the **Start join sequence** button  and then select the feature code from the list of line feature codes defined in the feature library. The selected feature code is added to the **Code** field.
3. In the map, tap the start point of the line sequence you want to create. The feature codes in the **Code** field are applied only to the start point. The feature code applied to the first point is also applied to the line.
4. Continue to tap points until the line sequence is complete.  
As you select each subsequent point, a line is drawn between the two selected points and the first point is then deselected.
5. To stop drawing lines, tap the **Draw line** button  again.

#### To draw an arc feature

1. Tap the **Draw arc** button .
2. If required, tap the **Start join sequence** button  and then select the feature code from the list of line feature codes defined in the feature library. The selected feature code is added to the **Code** field.
3. In the map, tap the start point of the arc you want to create.

**NOTE** – The points comprising the arc must have been observed consecutively. It will therefore not always be possible to join points with arcs.

4. Continue to tap points until the arc sequence is complete.

As you select each subsequent point, a red dashed line is drawn between the points until enough points are selected so that an arc can be drawn from the first point. As the arc is drawn the previous point is deselected.

5. To stop drawing arcs, tap the **Draw arc** button  again.

**TIP** – To draw a back-to-back arc, tap the **Back-to-back arc** button  after completing the first arc and before selecting the second point of the second arc. After the first part of the arc is drawn between the first and second points of the arc, the button returns to the unselected state.

#### To insert a break in a line

If you have joined points in a continuous line but want to break the line, select the point just before the break and tap **End join sequence** .

The **End join sequence** code is added to the **Code** field. The **End join sequence** code ensures the next point that has the same line feature code will not join to this line.

If the selected point was in the middle of a line, then the next point starts a new line.

#### To delete linework

1. In the map, select the lines or arcs that you want to delete.
2. Tap the **Delete** button .
3. Select the feature(s) to delete from the list and tap **Delete**.

Lines and arcs are deleted, and feature codes are removed from the affected points. However, the points remain in the job.

#### To create features using control codes in Measure codes

You can use **control codes** to create line, arc, or polygon features from points as you measure them. To do this, select the feature code for the point and then select the appropriate control code from the [CAD toolbar](#).

This topic describes how to create features using control codes in the **Measure codes** form. You can also create features using control codes in the **Measure points** or the **Measure topo** form.



When creating features as you measure observations:

- Always select the feature code first, followed by the control code.
- If required, you can select more than one control code for an observation. Simply select the required control codes on the toolbar.
- If the feature uses multiple line feature codes, or when stringing features, in the **Measure codes** form tap the **Multi-code** button  and select the line feature codes first **and then** select the control code(s) from the CAD toolbar. Buttons for the active control codes are not highlighted yellow when using the **Multi-code** button.

**NOTE –**

- *When creating features as you measure points, the workflow is slightly different when using the **Measure points** or the **Measure topo** form rather than the **Measure codes** form. In the **Measure codes** form you will select first the control code action from the CAD toolbar and then select the feature code because selecting the feature code typically triggers the measurement. In the **Measure points** or **Measure topo** form, you will first select the line feature code in the **Code** field and then use the CAD toolbar to append the control code to the **Code** field.*
- *Because control codes are normally only used once at the start or end of an item, when using the **Measure points** or **Measure topo** form the control codes are automatically removed from the **Code** field once the point is measured. The feature code remains in the **Code** field, ready for the next point in the feature.*

To measure a line using Measure codes

1. Tap **Start join sequence** . The **Start join sequence** code is added to the **Code** field.
2. Select the feature code for the feature in the **Measure codes** form. This feature code must be defined as a **line feature** in the feature code library. The line feature code is added to the **Code** field.
3. Measure and store the point.

4. Continue to measure points to form the line, assigning each point the same feature code as you used for the start point. As you measure and store each point, each line segment appears in the map.
5. When you reach the final point of the line, tap **End join sequence** . The **End join sequence** code is added to the **Code** field.

Tap **End join sequence**  to make sure the next point that has the same line feature code will not join to this line. However, if you always use **Start join sequence** when starting a line sequence, then ending a feature with **End join sequence** is optional.

6. Measure and store the point. This last stored point ends the line.

#### To measure a tangential arc using Measure codes

1. Tap **Start join sequence** . The **Start join sequence** code is added to the **Code** field.

**NOTE** – A tangential arc must be joined to at least one point so that the tangent information can be calculated.

2. Select the feature code for the feature in the **Measure codes** form. This feature code must be defined as a **line feature** in the feature code library. The line feature code is added to the **Code** field.
3. Measure at least one point, from which the arc will be drawn tangentially.
4. To start creating the arc, tap **Start tangential arc** . The **Start tangential arc** code is added to the **Code** field after the feature code.



The azimuth between this point and the previous point defines the entry tangent direction.

5. Measure and store the point.
6. Tap **End tangential arc** . The **End tangential arc** code is added to the **Code** field.
7. Measure and store the point. This last stored point ends the arc.
8. If required, continue measuring and storing points for the line feature.

**NOTE** – If an arc cannot be computed, the segment is drawn as a dashed red line to indicate that something is wrong. Situations where this will occur are:

- An arc is defined by two points and no tangency information is defined at the entry to the start arc point.
- A two point arc is defined as being tangential at both the start and end but these tangents do not work.

To measure a non-tangential arc using Measure codes

1. To include the arc as part of a line, tap **Start join sequence** . The **Start join sequence** code is added to the **Code** field.
2. Select the feature code for the feature in the **Measure codes** form. This feature code must be defined as a **line feature** in the feature code library. The line feature code is added to the **Code** field.
3. Tap **Start non-tangential arc** . The **Start non-tangential arc** code is added to the **Code** field.
4. Measure and store the point.
5. Continue to measure points to form the arc, assigning each point the same line feature code as you used for the start point. As you measure and store each point, each arc segment appears in the map.
6. When you reach the final point of the arc, tap **End non-tangential arc** . The **End non-tangential arc** code is added to the **Code** field.
7. Measure and store the point. This last stored point ends the arc.



**TIP** – To measure the transition point between two back-to-back arcs, tap both the **End arc** and the **Start arc** buttons before measuring the last point of the first arc.

**NOTE** – If an arc cannot be computed, such as when only two points of the non-tangential arc have been measured, the segment is drawn as a dashed red line to indicate that something is wrong.

### To measure a smooth curve using Measure codes

Use the **Start smooth curve** control code to create a smooth looking curve. Subsequent points are added to the smooth curve until you use the **End smooth curve** control code.

**NOTE** – If any point that makes up the curve has a null elevation then the entire curve is considered to be 2D, and will lie on the groundplane.

1. Tap **Start smooth curve** . The **Start smooth curve** code is added to the **Code** field.
2. Select the feature code for the feature in the **Measure codes** form. This feature code must be defined as a **line feature** in the feature code library. The line feature code is added to the **Code** field.
3. Measure and store the point.
4. Continue to measure points to form the curve, assigning each point the same line feature code as you used for the start point. As you measure and store each point, each curve segment appears in the map.
5. When you reach the final point of the arc, tap **End smooth curve** . The **End smooth curve** code is added to the **Code** field.
6. Measure and store the point. This last stored point ends the line.

### To measure a rectangle using Measure codes

To measure a rectangle, you can:

- Measure two points, where the first point **(1)** defines one corner of the rectangle, the second point **(2)** defines the next corner of the rectangle, and **one** of the points includes a **width value (3)**.

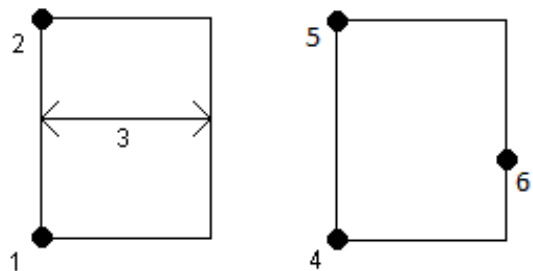



The first point uses the **Start rectangle** control code and the line feature code and the second

point uses just the line feature code. For one of the points, enter the width value after the line feature code. For example, **<Start rectangle> <Line feature> 8** for the first point and then **<Line feature>** for the second point.

- Measure three points, where the first point **(4)** defines one corner of the rectangle, the second point **(5)** defines the next corner of the rectangle, and the third point **(6)** is used to define the width of the rectangle. The first point uses the **Start rectangle** control code and the line feature code and the second and third points use just the line feature code.

**NOTE** – Rectangles are drawn respecting the elevation of all points.

To measure a rectangle if you do know the width:

1. Move to the location of the first corner of the rectangle.
2. Tap .
3. Select the feature code for the feature in the **Measure codes** form. This feature code must be defined as a **line feature** in the feature code library. The line feature code is added to the **Code** field.
4. Tap **Start rectangle** . The **Start rectangle** code is added to the **Code** field.
5. Enter the width of the rectangle in the **Multi-code** field. Enter a positive value to create the rectangle to the right of the line direction, and a negative value to create the rectangle to the left.
6. Measure and store the point.
7. Move to the second corner along the length of the rectangle. This point uses the same line feature code you selected for the first point.
8. Measure and store the point. This last stored point ends the rectangle, and the rectangle is drawn on the map.

To measure a rectangle if you do not know the width:

1. Move to the location of the first corner of the rectangle.
2. Tap **Start rectangle** . The **Start rectangle** code is added to the **Code** field.
3. Select the feature code for the feature in the **Measure codes** form. This feature code must be defined as a **line feature** in the feature code library. The line feature code is added to the **Code** field.
4. Measure and store the point.

5. Move to the second corner along the length of the rectangle. This point uses the same line feature code you selected for the first point.
6. Measure and store the point.
7. To measure another point to define the rectangle width, move to a location on the opposite side of the rectangle. This point uses the same line feature code you selected for the first point.
8. Measure and store the point. This last stored point ends the rectangle, and the rectangle is drawn on the map.

#### To measure a circle using the circle edge using Measure codes

To measure the circle, measure three points that lie on the edge of the circle. The first point uses the line feature code and the **Start circle (edge)** control code, and the second and third points just use the line feature code.

**NOTE** – Circles are drawn horizontal at the elevation of the first point with an elevation.

1. At the first point on the circle edge, tap **Start circle (edge)** . The **Start circle (edge)** code is added to the **Code** field.
2. Select the feature code for the feature in the **Measure codes** form. This feature code must be defined as a **line feature** in the feature code library. The line feature code is added to the **Code** field.
3. Measure and store the point.
4. Move to the second point on the circle edge. This point uses the same line feature code you selected for the first point.
5. Measure and store the point.
6. Move to the third point on the circle edge. This point uses the same line feature code you selected for the first point.
7. Measure and store the point. This last stored point ends the circle, and the circle is drawn on the map.

To measure a circle using the center of the circle using Measure codes

To measure a circle using the center of the circle, you can:

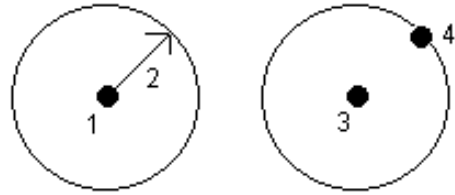

- Measure a single point **(1)** at the center of the circle where that point uses the **Start circle (center)** control code and the line feature code, followed by a radius value **(2)**. For example, **<Start circle (center)>** **<Line feature>** **8**.



- Measure one point **(3)** at the center of the circle, and then measure a second point **(4)** which lies on the edge of the circle and is used to define the radius of the circle. The first point uses the **Start circle (center)** control code and the line feature code and the second point uses only the line feature code. For example, **<Line feature>** **<Start circle (center)>** for the first point and then **<Line feature>** for the second point.

**NOTE** - Circles are drawn horizontal at the elevation of the first point with an elevation.

To measure a circle when you know the radius:

1. Tap .
2. Select the feature code for the feature in the **Measure codes** form. This feature code must be defined as a **line feature** in the feature code library. The line feature code is added to the **Code** field.
3. At the center of the circle, tap **Start circle (center)** . The **Start circle (circle)** code is added to the **Code** field.
4. Enter the radius value in the **Multi-code** field.
5. Measure and store the point.

The circle is drawn on the map.

To measure a circle when you do not know the radius:

1. At the center of the circle, tap **Start circle (center)** . The **Start circle (circle)** code is added to the **Code** field.

2. Select the feature code for the feature in the **Measure codes** form. This feature code must be defined as a **line feature** in the feature code library. The line feature code is added to the **Code** field.
3. Measure and store the point.
4. To measure a point to define the radius, move to a location on the circle edge. This point uses the same line feature code you selected for the first point.
5. Measure and store the point. This last point completes the circle, and the circle is drawn on the map.

To add an offset to a line or arc

You can add a horizontal and/or vertical offset value to offset lines and arcs.

**NOTE** - You cannot offset linework created using the smooth curve control codes.

For example, when surveying a curb and gutter you can measure points at the flow line (invert) of the gutter using a line code and then set the horizontal and vertical offset control codes for the curb and gutter. For example, <Line code> <Horizontal offset> 0.3 <Vertical offset> 0.04.

Refer to the following real world example of a curb and gutter where FL is the line code for the flow line, H is the horizontal offset control code and V is the vertical offset control code:

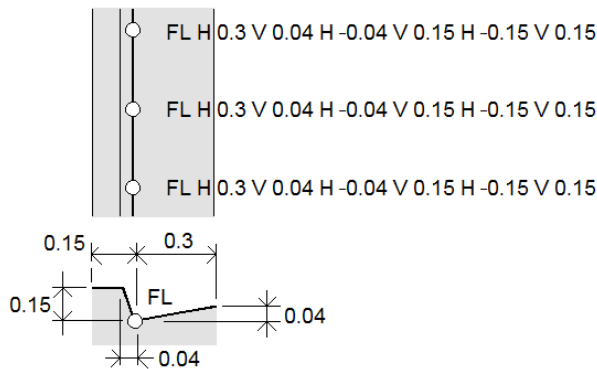

To apply offset values to the **next point** to be measured:

1. Tap **Offset** .
2. From the **Number** field, select the number of offsets to define.
3. Enter the **Horizontal offset** and **Vertical offset** values.



A positive **Horizontal offset** value offsets to the right of the line direction, a negative value offsets to the left.

A positive **Vertical offset** value offsets above the line, a negative value offsets below the line.

#### 4. Tap **Accept**.

The offset information is shown in the **Code** field, indicating the offset value(s) will be applied to the next measurement.

**NOTE** - When applying offsets, Spectra Geospatial recommends using the **Start join sequence** and **End join sequence** control codes to start and end the line. The **End join sequence** control code automatically turns off the offset button and removes the offset text.

#### Special control codes for joining and skipping points

- To join the current point to a selected point, tap **Join to named point** and then enter the name of the point or select the point in the map and tap **Accept**.
- To join a point to the first point in the sequence that has the same line feature code, tap **Join to first (same code)**.
- To measure a point but not join it to the last measured point, tap **Skip join** and then measure and store the point.

#### To set the next point name

1. To check what the next point name will be, tap **Next point name**. The text after the **Next point name** menu item indicates the next point name.
2. To set the name for the next point, tap **Next point name** and select **Next point name**.
3. Enter the point name and the code for the next point.
4. Tap **Accept**.

#### Quick reference: CAD toolbar with Measure codes





Refer to the example features and the button-press information below to create these features in **Measure codes** using the [CAD toolbar](#).

**NOTE** - For detailed step by step information on using each function, see [To create features using control codes in Measure codes](#).

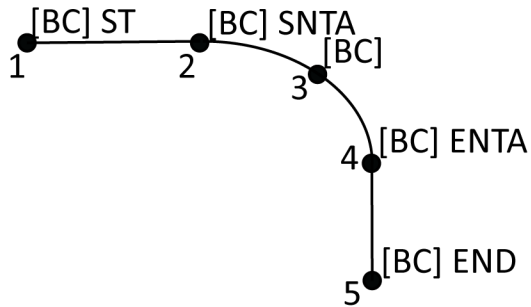
**TIP** – To create back curb (**BC**) or standard manhole (**STMH**) features, define the **BC** and **STMH** feature codes as lines in the feature library and make sure the feature library includes definitions for the appropriate control codes.

To create the example line and non-tangential arc feature



1. For point 1, tap  + [BC].
2. For point 2, tap  + [BC].
3. For point 3, tap [BC].
4. For point 4, tap  + [BC].
5. For point 5, tap  + [BC].

To create the example three-point circle (edge) feature

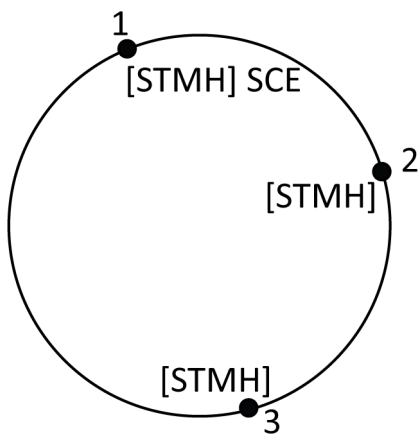

1. For point 1, tap  + [STMH].
2. For point 2, tap [STMH].
3. For point 3, tap [STMH].

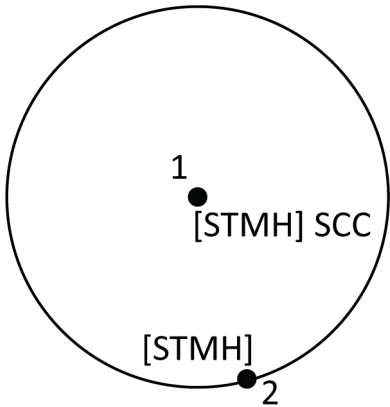

To create the example two-point circle (center) feature

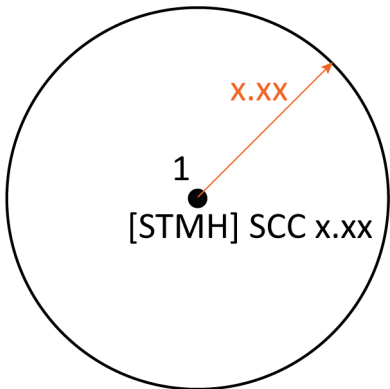

1. For point 1, tap  + [STMH].
2. For point 2, tap [STMH].

To create the example one-point circle (center) feature



1. Tap .
2. Tap [STMH] +  + radius value [x.xx].

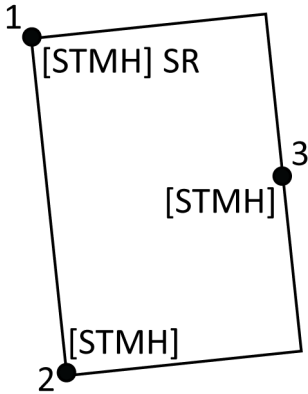

To create the example three-point rectangle feature



1. For point 1, tap  + [STMH].
2. For point 2, tap [STMH].
3. For point 3, tap [STMH].

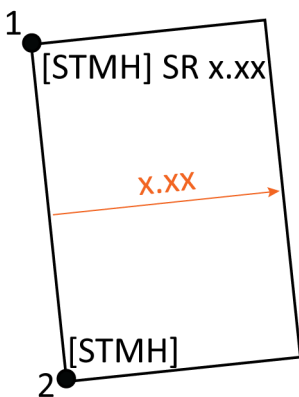

To create the example two-point rectangle feature

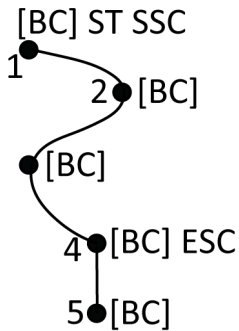

1. Tap .
2. For point 1, tap [STMH] +  + width value [(+/-)x.xx].
3. For point 2, tap [STMH].

To create the example smooth curve feature



1. For point 1, tap  +  [BC].
2. For point 2, tap [BC].
3. For point 3, tap [BC].
4. For point 4, tap  + [BC].
5. For point 5, tap [BC].



Quick reference: CAD toolbar with Measure points or Measure topo

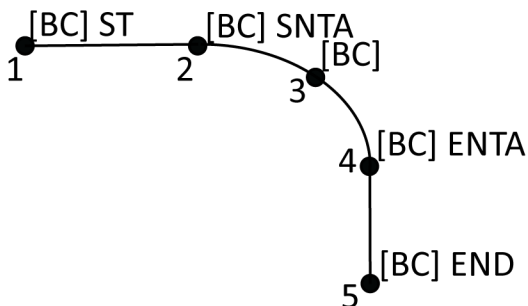

Refer to the example features and the button-press information below to create these features in the **Measure points** or **Measure topo** form using the [CAD toolbar](#).

**TIP** – To create back curb (**BC**) or standard manhole (**STMH**) features, define the **BC** and **STMH** feature codes as lines in the feature library and make sure the feature library includes definitions for the appropriate control codes.

To create the example line and non-tangential arc feature



1. For point 1, select [BC] + tap .
2. For point 2, select [BC] + tap .
3. For point 3, select [BC].

4. For point 4, select **[BC]** + tap .
5. For point 5, select **[BC]** + tap .

To create the example three-point circle (edge) feature

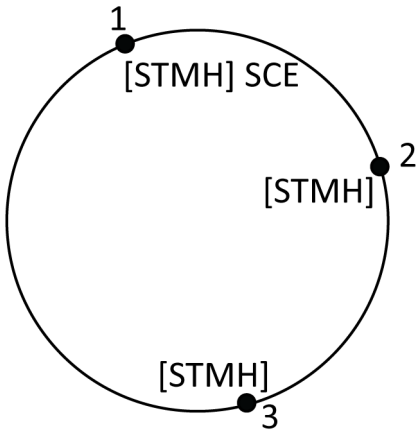

1. For point 1, select **[STMH]** + tap .
2. For point 2, select **[STMH]**.
3. For point 3, select **[STMH]**.

To create the example two-point circle (center) feature

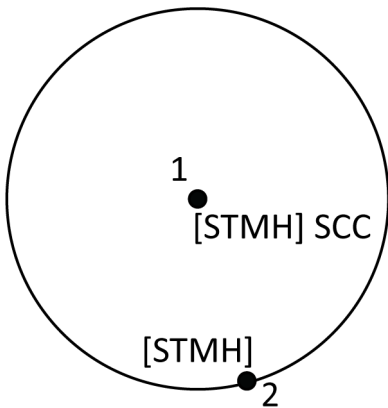

1. For point 1, select **[STMH]** + tap .
2. For point 2, select **[STMH]**.

To create the example one-point circle (center) feature

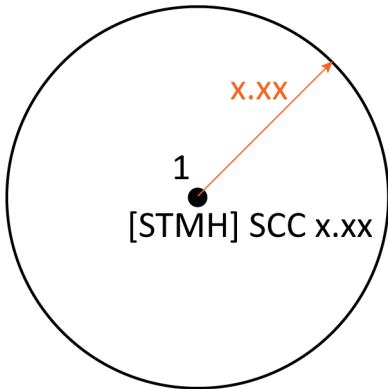

1. Select **[STMH]** + tap  + enter the radius value **[x.xx]**.

To create the example three-point rectangle feature

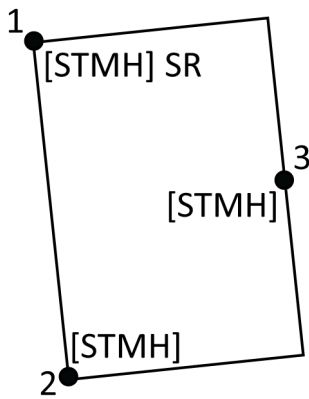

1. For point 1, select **[STMH]** + tap .
2. For point 2, select **[STMH]**.
3. For point 3, select **[STMH]**.

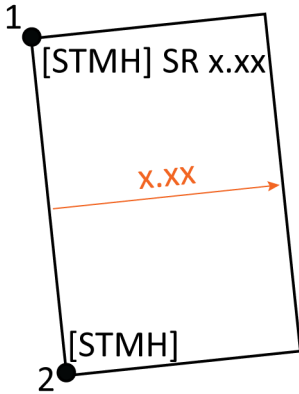

To create the example two-point rectangle feature

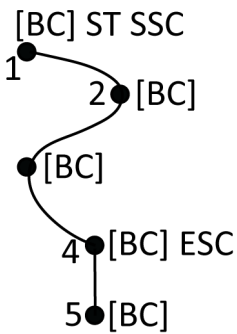

1. For point 1, select [**STMH**] + tap  + enter the width value [(+/-)x.xx].
2. For point 2, select [**STMH**].

To create the example smooth curve feature



1. For point 1, select [**BC**] + tap  + .
2. For point 2, select [**BC**].
3. For point 3, select [**BC**].
4. For point 4, select [**BC**] + .
5. For point 5, select [**BC**].

### Snap-to toolbar

The **Snap-to** toolbar provides a simple way to select locations on objects in the map by snapping onto a specific point, even if no point exists. For example, you can use the **Snap-to** toolbar to accurately select the end point of a line or polyline, or the center of an arc, from linework in a map file such as an IFC or DXF file.



To display the toolbar, tap  on the map toolbar and then select **Snap-to toolbar**. The **Snap-to** toolbar is only available when you are using General Survey.

To "snap" to a location on a feature, tap the appropriate tool in the **Snap-to** toolbar and then select the line, polyline, or arc in the map.



To use the same tool multiple times, tap and hold the appropriate tool in the **Snap-to** toolbar to keep the tool selection active and then select the features in the map. For example, to select the end points of multiple lines, tap and hold the **Snap to end** button  and then select each line. To change to a different tool, tap a different button in the **Snap-to** toolbar.





If a point does not already exist at the selected location, Origin calculates a point. You can use calculated points like any other point, for example to stake out or to perform other Cogo functions. To be able to reuse a calculated point in the future, create a point from the calculated point and store it to the job.

Calculated points are automatically removed when you update the map, such as when changing map settings or linked files. To remove calculated points at any time, tap the **Clear selection** button on the toolbar, or double-tap in the map.

**TIP** – It is also possible to create calculated points at specific locations using Cogo functions. See [Cogo calculations](#).

#### Snap to tools

Select	Function
<b>Snap to midpoint</b>	 Snap to the midpoint of the selected line, polyline, or arc.
<b>Snap to end</b>	 Snap to the nearest end point of the selected line or polyline.
<b>Snap to intersection</b>	 Snap to the real or apparent intersection of two lines or polylines.  An <b>apparent intersection</b> occurs when two lines or polylines do not physically intersect but could be extended to intersect at a projected point. To snap to an apparent intersection you must select two lines or polylines.  A <b>real intersection</b> occurs at the position where two lines or polylines cross (in plan view). To snap to a real intersection you need only select one line or polyline close to the crossing point.

Select		Function
<b>Snap to PI of arc</b>		Snap to the point of intersection (PI) of the selected arc.
<b>Snap to center</b>		Snap to the center of the selected arc.
<b>Snap to nearest</b>		Snap to the nearest point of the selected line, polyline, or arc.
<b>Clear selection</b>		Removes calculated points and lines and clears the selection of any other items in the map. Alternatively, double-tap anywhere in the map.

#### To create points from calculated points

1. Select the calculated point (or points) in the map.
2. Tap and hold in the map and select **Create point**. This option is not available if you have selected a mix of points and calculated points.
3. Enter the **Point name**.
4. If required, enter the code for the point in the **Code** field.
5. Tap **Store**.

#### Limit box

The **Limit box** enables you to exclude data in the map to view more clearly the area you are interested in. The **Limit box** is especially useful when viewing IFC files, where you can exclude parts of the model so that you can view inside it.



You can set the size of the **Limit box** using the vertical, side, or front/back sliders, or by entering limit values.

**NOTE** - The **Limit box** is not supported when Origin is running on an Android device.

#### Limit box toolbar

To display the **Limit box** tools, tap  on the map toolbar and then select **Limit box**. The **Limit box** toolbar appears to the right of the map.

To use the **Limit box** tools:

- Tap  to set limits for the vertical slider.
- Tap  to set limits for the side slider.

- Tap  to set limits for the front/back slider.

**NOTE** – The **Limit box** sliders are aligned with the **Reference azimuth** field of the **Cogo settings** screen of the job properties (see [Cogo settings, page 99](#)). To enter or edit the **Reference azimuth** value return to the **Cogo settings** screen, or tap  in the Map toolbar and select **Settings**, select **Reference azimuth** from the **Map orientation** field and then edit the **Reference azimuth** field. To make sure the front surface of the limit box aligns with map data, for example with the front facade of a model, in the map tap a line or polyline used in the front facade and then tap **Review**. In the review pane, tap **Details** and copy the value in the **Azimuth** field and then paste the value into the **Reference azimuth** field.

To set the size of the Limit box using the sliders

To exclude parts of the map using the **Limit box** slider:

1. Tap the appropriate **Limit box** toolbar button.

The **Limit box** slider appears next to the **Limit box** toolbar. The values on the **Limit box** slider show the limits of each slider, and the center of the map (vertical slider) or the width of the limit box (side and front/back sliders).

**NOTE** – If the **Reference azimuth** value for the job is not  $0^\circ$ , the side and front/back sliders do not show limit values. Only the width of the limit box is shown.

2. Tap and drag the appropriate arrow along the slider to set the limit. The **Limit box** controls are dynamic and update to reflect the changes made.
3. Continue to drag the controls along the slider to hide more of the map. The scale of each change depends on the zoom level of the map.

**TIP** – To hide the slider and retain the set limits, tap the **Limit box** toolbar button again.

To set the size of the Limit box by entering values

**NOTE** – If the **Reference azimuth** value for the job is not  $0^\circ$ , you cannot edit the side and front/back limit values and must use the side and front/back sliders to change the size of the limit box.

To manually enter limit values, tap and hold the appropriate toolbar **Limit box** button. Enter limit values in the pop-up dialog.

To manually edit the vertical limit:

1. Tap and hold .
2. To edit the center value, enter the value in the **Center** field.

3. To set the thickness of the viewable area, edit the value in the **Thickness** field. The values in the **Top** and **Bottom** limit fields update automatically.
4. To lock the **Thickness** value, tap . This is useful if you want to inspect 'slices' of a model, for example when viewing each floor of a building. You can set and lock the thickness and then just edit the one of the other values (**Top**, **Center** or **Bottom**) to inspect the next 'slice' of the model.

### Clearing limits

To clear all limits and stop using the **Limit box**, tap  on the map toolbar and then select **Limit box**. To clear all limits but keep using the **Limit box**, tap and hold any **Limit box** toolbar button and then tap **Clear all limits** in the pop-up dialog.

To clear some limits, tap and hold the appropriate **Limit box** toolbar button and then tap the **Clear limits** button for the selected elevation.

### To store a point

If the controller is connected to a GNSS receiver, or you are using a controller with internal GPS, you can quickly store the current position of the receiver without having to start a survey. This is especially useful for storing waypoints so that you can easily return to locations of interest.

**NOTE** – *When using a controller with internal GPS, a connected GNSS receiver is always used in preference to the internal GPS.*

1. To store the current position:
  - Tap the receiver icon in the status bar and select **Position**. To store the position, tap **Store**. See [Current position information](#).
  - When navigating to a location, in the **Navigate to point** screen tap **Position**.
  - Make sure no features are selected in the map and then tap and hold an empty space in the map and select **Store a point**.
2. Make sure the value in the **Antenna height** field is correct.
3. Tap **Store**.

### To offset a line or polyline

1. In the map, select the line/polyline to offset.
2. Tap and hold in the map and select **Offset line/Offset polyline**.

3. Enter the **Horizontal offset** and/or **Vertical offset** value. To change the offset direction, tap ► next to the appropriate offset field.
4. To change how distances are calculated, tap **Options**. See [Cogo settings, page 99](#).
5. Enter the name and, if required, the code for the new line/polyline.
6. If you are offsetting a polyline, enter the **Start station** and **Station interval**.
7. Tap **Store**.

### To create a surface

If you have three or more 3D points in the job, you can create a surface and store it as a triangulated terrain model (TTM) file in the current project folder. You can then use the surface to calculate a volume. See [Compute volume, page 238](#).

1. In the map, select three or more 3D points.
2. Tap and hold in the map and select **Create surface**.
3. Enter the surface name. Tap **OK**.

The surface is linked to the current job as a linked map file and appears in the map.

### To change the appearance of the surface

1. In the map, tap  and select **Settings**.
2. In the **Surfaces** group, tap the check box(es) to show or hide:
  - a color gradient
  - surface triangles
  - the sides of the surface
3. To raise or lower the surface when viewing from the map, enter a value in the **Offset to DTM (Vertical)** field .

### To modify the surface

You may need to modify the surface before performing a volume calculation.

**NOTE** - To modify the surface, you must have only one TTM model displayed in the map, which must be set to **visible and selectable**. To change visibility/selectability settings, tap  in the map toolbar to open the **Layer manager** and select the **Map files** tab. In addition, **Surface triangles** must be

enabled in the map. To enable this, tap  in the Map toolbar and select **Settings**. In the **Surface (TTM, DXF and LandXML)** group, select **Triangles** or **Color gradient + triangles** in the **Display** field.

1. Tap  and select **Plan**.

2. In the map, select one or more triangles in the surface.

A triangle can be selected only if no other items, such as points, are selected. To make triangle selection easier, hide other items using the **Filter** softkey. To select triangles, the map must be in **Plan** view.

3. Tap and hold in the map and select **Delete selected triangles**. This option is not available if you selected all the triangles in the surface.

4. Tap **OK**.

### Map tap and hold options

Tap and hold in the map area to quickly select a common task. The tasks available depend on the number and type of features selected, and whether the features are in the job or in a linked file.

When **no features** are selected, you can tap and hold on the map and select:

- [Select](#)
- [Select all surfaces](#)
- [CAD toolbar](#)
- [Store a point](#)
- [Turn to](#)
- [Key in point](#)
- [Set point details](#)
- [Check backsight](#)

**NOTE -**

- The **Key in point** option is only available when no point is selected and the map is in Plan view.
- The **Set point details** option is not available when the CAD toolbar is displayed in the map.
- **Check backsight** is available only in conventional surveys.
- There are fewer tap and hold menu items available when you are using the CAD toolbar in drawing mode.

Tap and hold menu options for features selected in the map that are in the current job

**NOTE -** There are fewer tap and hold menu items available when you are using the CAD toolbar in drawing mode.

When one point in the job is selected:

- [Review](#)
- [Select](#)
- [CAD toolbar](#)
- [List selection](#)
- Clear selection
- Delete
- [Stake out point](#)
- Measure calibration point
- [Navigate to point](#)
- [Turn to](#)
- [Set point details](#)
- [Check shot](#)

**NOTE –**

- *If you select a point with the same name as another point in the job, and then select **Review** or **Delete**, a list of the duplicate points appears. Select the point you want to review or delete.*
- ***Turn to** is available in a conventional survey when a station setup has been completed and the map is in Plan view. If multiple points are selected then the instrument turns to the last selected point.*
- ***Check shot** is available only in conventional surveys.*
- *The **Set point details** option is not available when the CAD toolbar is displayed in the map.*

When two points in the job are selected:

- [Review](#)
- [Select](#)
- [CAD toolbar](#)
- [List selection](#)
- Clear selection
- Delete
- [Stake out point](#)
- [Stake out line](#)
- [Turn to](#)
- [Compute inverse](#)
- [Key in line](#)
- [Key in polyline](#)

**NOTE –** ***Turn to** is available in a conventional survey when a station setup has been completed and the map is in Plan view. If multiple points are selected then the instrument turns to the last selected point.*



Three or more points are selected

- [Review](#)
- [Select](#)
- [CAD toolbar](#)
- [List selection](#)
- Clear selection
- Delete
- [Stake out point](#)
- [Turn to](#)
- [Compute inverse](#)
- [Area calculations](#)
- [Key in arc: Three points](#)
- [Key in arc: Two points and center point](#)
- [Key in polyline](#)
- [Create surface](#)
- [Compute volume](#)

**NOTE** – **Turn to** is available in a conventional survey when a station setup has been completed and the map is in Plan view. If multiple points are selected then the instrument turns to the last selected point.

A Line is selected

- [Review](#)
- [Select](#)
- [CAD toolbar](#)
- [List selection](#)
- Clear selection

Job data

- Delete
- [Stake out line](#)
- [Area calculations](#)
- [Compute intersection](#)
- [Subdivide a line](#)
- [Offset line](#)

A Polyline is selected

- [Review](#)
- [Select](#)
- [CAD toolbar](#)
- [List selection](#)
- Clear selection
- Delete
- [Stake out polyline](#)
- [Area calculations](#)
- [Compute intersection](#)
- [Offset polyline](#)

An Arc is selected

- [Review](#)
- [Select](#)
- [CAD toolbar](#)
- [List selection](#)
- Clear selection
- Delete

- [Stake out arc](#)
- [Area calculations](#)
- [Compute intersection](#)
- [Subdivide an arc](#)

Tap and hold menu options for features selected in the map that are in a linked file

**NOTE –**

- *If you select one or more triangles in a surface (TTM files only), the **Delete selected triangles** option is available from the tap and hold menu.*
- *You cannot use the Origin software to delete points from linked files. Points from linked files do not appear in the **Review** screen list of deletable points.*
- ***Check backsight** and **Check shot** options are available only in conventional surveys.*
- *There are fewer tap and hold menu items available when you are using the CAD toolbar in drawing mode.*

One point is selected

- [Review](#)
- [Select](#)
- [CAD toolbar](#)
- [List selection](#)
- Clear selection
- [Stake out point](#)
- Measure calibration point
- [Navigate to point](#)
- [Turn to](#)
- [Set point details](#)

Job data

- [Check backsight](#)

**NOTE -**

- *Turn to* is available in a conventional survey when a station setup has been completed and the map is in Plan view.
- The **Set point details** option is not available when the CAD toolbar is displayed in the map.

Two points are selected

- [Review](#)
- [Select](#)
- [CAD toolbar](#)
- [List selection](#)
- Clear selection
- [Stake out point](#)
- [Stake out line](#)
- [Turn to](#)
- [Compute inverse](#)
- [Key in line](#)
- [Key in polyline](#)

**NOTE - Turn to** is available in a conventional survey when a station setup has been completed and the map is in Plan view. If multiple points are selected then the instrument turns to the last selected point.

Three or more points are selected

- [Review](#)
- [Select](#)
- [CAD toolbar](#)
- [List selection](#)

- Clear selection
- [Stake out point](#)
- [Turn to](#)
- [Compute inverse](#)
- [Area calculations](#)
- [Key in arc: Three points](#)
- [Key in arc: Two points and center point](#)
- [Key in polyline](#)
- [Create surface](#)
- [Compute volume](#)

**NOTE - Turn to** is available in a conventional survey when a station setup has been completed and the map is in Plan view. If multiple points are selected then the instrument turns to the last selected point.

A Line is selected

- [Review](#)
- [CAD toolbar](#)
- [List selection](#)
- Clear selection
- [Stake out line](#)
- [Area calculations](#)
- [Compute intersection](#)
- [Offset line](#)

A Polyline is selected

- [Review](#)
- [CAD toolbar](#)

Job data

- [List selection](#)
- Clear selection
- [Stake out polyline](#)
- [Area calculations](#)
- [Compute intersection](#)
- [Offset polyline](#)

An Arc is selected

- [Review](#)
- [CAD toolbar](#)
- [List selection](#)
- Clear selection
- [Stake out arc](#)
- [Area calculations](#)
- [Compute intersection](#)

Surfaces in an IFC file are selected

Single surface:

- [Measure to surface](#)
- [Compute center point](#)
- [Compute centerline](#)

Multiple surfaces:

- [Measure to surface](#)

## Working with media files

Media files, for example images, can be:

- Uploaded as a file
- Captured using the controller's internal camera

Media files can be linked to a job or to a point in the job. See [Media files, page 110](#).

If you are using a feature library that uses media file attributes, you can capture an image and link it to the appropriate attribute. See [To link an image to an attribute, page 488](#).

### Adding additional information to images

If required, you can:

- Add geographical identification metadata to images (known as geotagging).

Metadata includes position coordinates that is written to the EXIF header of the image (EXIF = EXchangeable Image File format). The geotagged image can be used in office software such as Survey Office. This requires the job to have a coordinate system.

- Add linework, polygons or text to images by drawing on them. See [To draw on an image, page 185](#).

### Storing images

By default, images captured using the controller's integrated camera are stored in the **<job name> Files** folder. Storing images in the current **<job name> Files** folder facilitates automatic upload to the cloud with the job, and makes linking the images to a job, a point, or an attribute of a point possible. When you [capture an image using the controller's integrated camera](#) from within the Origin software, the image file name is automatically entered into the **File name attribute** field when the image is saved to the **<job name> Files** folder.

**NOTE** – If the controller is an Android device, you **must** open the controller camera application from within the Origin software for Origin to be able to detect when an image is saved to the **Pictures** folder. If you have already opened the camera application, close it and open it from within Origin.

### To change the image file linked to a point or attribute

1. You can change the image file linked to an attribute in the **Review job** or **Point manager** screen:
  - In the **Review job** screen, select the point you want to edit and tap **Edit**.
  - In the **Point manager** screen, select the point you want to edit and tap **Details**.
2. In the **Point manager** screen, select the point you want to edit and tap **Details**.
3. If the image is linked to an attribute, tap **Attrib**. If the image is linked to the point, tap **Media files**. (In portrait mode, swipe right to left along the row of softkeys to view the **Media files** softkey.)

4. In the photo file name field, tap  and tap **Select file**. Browse to the location of the file you want to link and select it.

The name of the image appears in the photo file name field.

**TIP** – To facilitate automatic upload of images to the cloud with the job, the image should be located in the current **<job name> Files** folder.

5. Tap **Store**.

#### To geotag an image

Geotagging is assigned to JPG images linked as a file or image attribute or media file to a point.

**NOTE** – *It is not possible to remove geotagging information from an image.*

#### To use position information from the connected receiver instrument

1. Tap  and select **Job**. The current job is already selected.
2. Tap **Properties**.
3. Tap **Media files**.
4. In the **Link to** field, select **Previous point**, **Next point** or **Point name**.
5. Select **Geotag images**.
6. Tap **Accept**.

Alternatively, when capturing images to link to attributes, in the attribute entry screen, tap **Options** and then select **Geotag images**.

#### To use position information from the GPS in the controller

1. Tap  and select **Instrument / Camera**. The camera application on the controller opens.
2. To change to the rear-facing camera, tap the **Switch camera** icon in the top left.
3. Tap the **Settings** icon.
4. Click **Choose whether camera can use location information**.
5. Tap **Yes** to switch applications.
6. Enable the **Location service** switch.



7. Return to the camera application and tap the image capture button.

### To capture an image using the controller camera

You can capture an image using the controller's integrated camera from within the Origin software. Images captured using the controller's integrated camera are typically saved to the **Pictures** folder. For some devices the location these files are saved to can be changed, but Spectra Geospatial recommends you save the files to the **Pictures** folder because the Origin software monitors the **Pictures** folder and moves images saved to the Pictures folder to the **<job name> Files** folder. If the files are saved to another location, the software cannot detect the arrival of new files and cannot move them.

**NOTE** - If the controller is an Android device, you **must** open the controller camera application from within the Origin software for Origin to be able to detect when an image is saved to the **Pictures** folder. If you have already opened the camera application, close it and open it from within Origin.

1. Tap **≡** and select **Instrument / Camera**. The camera application in the controller opens.
2. If the screen shows an image of you then the front-facing (selfie) camera is selected. To change to the rear-facing camera, tap the **Switch camera** icon in the top left.
3. To change the camera or image settings, tap the **Settings** icon and make your changes. For more information, refer to the documentation for your controller.
4. Position the controller to capture the required image and then tap the camera button or the **OK** button on the controller to capture the image.
5. To close the camera, tap the screen and then tap **X** in the top right.

If you selected the **Show with new media file** option when you configured the media file settings, the media file screen appears showing a thumbnail of the image. This enables the **Link to** method to be changed and, if linking by point name, the point name.

If the **Show with new media file** option was not selected, the image is not shown and is automatically linked to the option you selected in the **Media file** screen of the job properties.





6. Tap **Accept**.

### To draw on an image

You can draw linework, polygons or add text to any image in the job using the **Draw** toolbar. The **Draw** toolbar is available when you view an image file in the **Review job** screen.

**TIP** – When you select a media file in the **Review job** screen, the **Media file** window appears. To make the **Media file** window full-size, click **Expand**.

To draw on the image:

1. Tap **Draw**.
2. From the **Draw** tool bar select the appropriate option to draw items on the image:
  -  freehand linework
  -  lines
  -  rectangles
  -  ellipses
  -  text

**TIP** – To split text onto a new line, press **Shift + Enter** or **Ctrl + Enter**.

3. To reposition the item, tap and hold on the item and then drag it.

To undo an edit, tap .

4. To change the line width, style, and color or the text color, background color, and size of the item, tap and hold the item and then tap **Options**.
5. To save a copy of the original image to the **<project>\<job name> Files\Original Files** folder, tap **Options** and select **Save original image**.

**NOTE** – *If you do not have a job open, images are saved to the current project folder and original images are saved to the **Original Files** folder inside the current project folder.*

To view the original image in the **Review Job** screen, tap **Original**. To return to the edited image, tap **Modified**.

6. Tap **Store**.

## Reviewing data

Origin provides several ways to review data in the current job:

- Select items in the map and then tap **Review** to view details about the selected items.
- Tap ≡ and select **Job data / Review job** to view the log detailing the history of points stored in the job as well as all changes made to job settings. Records are listed in chronological order.
- Tap ≡ and select **Job data / Point manager** to view the database of all the points and observations in the job as well as linked files. Usually point records are listed in ascending order of point name, but if you choose to display records by **Target height**, all observations are listed appear in the order that they occur in the database.

You can add notes to the job, edit target/antenna height records, and edit code records from the **Review job** or **Point manager** screen.

To review media files or occupation warnings, use **Review job**.

To edit point name and coordinate records, or to delete points or features, use **Point manager**.

### Review job

1. Tap ≡ and select **Job data / Review job** or tap ≡ and select **Review job** from the **Favorites** list.
2. Tap a record to select it or use the softkeys or arrow keys to navigate the database.

To move to the end of the database quickly, highlight the first record and press the up arrow key.

To search for a particular item, tap **Search** and select an option. You can search by current record type, or search for points by name, code or class. See [Managing points with duplicate names, page 200](#).

3. To see more information about an item, tap the record. Some fields, for example, **Code** and **Antenna height**, can be edited.

If there are no coordinates shown, check the **Coordinate view** setting. To see grid coordinates in review, the **Coordinate view** must be set to grid, and the coordinate system settings for the job must define a projection and datum transformation.

In conventional surveys, an observation is displayed with null coordinates until the observation to the backsight is stored.

**TIP** – To view the point details alongside the map, select the point(s) in the map and then tap and hold in the map and select **Review**.

### To review and edit media files

1. Select the media file record in the job or in the point record.
2. Tap **Details**. The image appears.
3. Tap **Expand**.
4. To change the **Link to** method and the name of any linked point, tap the **Link** softkey. See [Media files, page 110](#).

**TIP** – To remove the link to the job or a point, select **None**. The media file remains in the project folder.

**NOTE** – *If the image is annotated with an information panel and you edit values defining the measured point for the image such as the code and descriptions, the information panel is not updated if you change the method and point name.*

5. To mark up an image, tap **Draw**. See [To draw on an image, page 185](#).

### To insert a note in the job

1. Select a record.
2. Tap **Note**. The **Note** screen that appears displays the date and time that the current record was created.
3. Enter the note and then tap **Accept**. The note is stored with the current record. In **Review job**, the note appears below the record with the note icon.

### To review warning records

For points measured using a GNSS receiver with an integrated tilt sensor, **Review Job** shows the excess movement, excess tilt, or poor precision warnings given for the point. To view these, expand the point record and then expand the **Quality control / QC1** records.

The following records are available:



- The **Warnings** section shows the warnings were given during the occupation when the point was being measured.
- The **Conditions at storage** section shows the error conditions that were present at the time the

point was stored.

The conditions at storage have a major impact on the measured coordinates of the point.

## Point manager

**Point manager** enables you to easily review observations and the best point and all duplicate points for a selected point.

To open **Point manager**, tap  and select **Job data / Point manager** or tap  and select **Point manager** from the **Favorites** list. The **Point manager** screen shows a tabulated tree structure of all points and observations in the job database and linked files.

Using **Point manager** you can easily edit:

- Target and antenna heights (single or multiple)
- Point names
- Point coordinates
- Codes (single or multiple)
- Descriptions (single or multiple)
- Notes

## Viewing the data

By default, points are listed by name. When there are duplicate points of the same name, the best point always appears first. All occurrences of points of the same name, including the best point, appear in a list below the best point.

**NOTE** – *When the data is in the **Target height** view, all observations are listed in the order that they occur in the database.*

To view more information about a point, you can:

- Tap + to expand the point tree list and reveal all associated points and observations. Expand the subtree to view individual point information. These records can include the point coordinates, observations, antenna or target details, and quality control records.
- Tap a point, or select it and tap **Details** to open the same point details form as seen in **Review job**. This allows you to edit information such as the point code and attributes.

To change the format of the indented coordinates or the observations that appear when you expand the point tree, tap the coordinates or observations displayed, or highlight them and press the space

key. In the list that appears, select the new data view. This allows you to review the raw conventional or GNSS observations and the Grid coordinates at the same time.

To view additional columns, tap **Display** and select the required columns.

To sort data by column value, tap the column header.

To include deleted points in the displayed information, tap **Options** and then select **Display deleted points**. (In portrait mode, swipe right to left along the row of softkeys to view the **Options** softkey.)

To filter data by wildcard search, tap . See [To filter data using wildcard search, page 190](#).



### Adding or editing notes using Point manager

When you edit point records in **Point manager**, the software automatically inserts notes into the job database to record what was edited, the original data, and the time of the edit. You can view the edited records and notes in **Review job**.

To enter a note or change an existing note, tap the **Note** field. Enter the note details and then tap **Accept**.

### To filter data using wildcard search

To filter the displayed information using wildcard matching, do one of the following:

- In the **Point manager** screen, tap .
- Tap  in the **Map** toolbar, select the **Filter** tab and then tap .

The **Wildcard search** screen appears. Enter your search criteria as needed in the **Point name**, **Code**, and **Note** fields and, if enabled, the **Description** fields.

To include wildcard searching, use \* (for multiple characters) and ? (for a single character). The filters specified for the separate fields are processed together and only points that meet the criteria of all the filters will appear. Use \* in any field that you do not want to filter. Filtering is not case sensitive. For example:

Point name	Code	Descr. 1	Descr. 2	Note	Example results
*1*	*	*	*	*	1, 10, 2001, 1a
1*	*	*	*	*	1, 10, 1a
1?	*	*	*	*	10, 1a
*1*	Fence	*	*	*	All points with a name that contains a 1 and where code = Fence

Point name	Code	Descr. 1	Descr. 2	Note	Example results
*1*	*Fence*	*	*	*	All points with a name that contains a 1 and a code that contains Fence
1???	*	*	*	wrong*	All points with a name that starts with 1 and is 4 characters long and a note that starts with wrong
*	Tree	Aspen	25	*	All points where code = tree and Description 1 = Aspen and Description 2 = 25

**TIP** - The search results return points from files linked to the job that meet your search criteria even if they are not currently displayed in the map.

The filter icon is colored yellow to indicate when a filter is applied. To disable the filter, tap **Reset**, or set all fields to \*.

In the Map, filter settings are cleared when you change jobs.

In Point manager, filter settings are remembered, but are not applied if Point manager is closed. To reactivate filter settings, tap  and then tap **Accept**.

### To edit antenna and target height records

You can review and edit target height records after measuring points.

**NOTE** - The target height record refers to conventional target heights and the GNSS antenna heights.

To change a target/antenna height record and automatically update **all** observations using that height record, use **Review job**.

If there are a group of target/antenna height records and only some of them need to be changed, use **Point manager**.

---

 **CAUTION** – Take care when changing target/antenna height records. In particular, be aware of the following:

- When you change target/antenna height record in the database, stakeout deltas, Cogo points, averaged points, calibrations, resections, and traverse results are not automatically updated. Re-observe staked out points, and recalculate Cogo points, averaged points, calibrations, resections, and traverses.
- Offset points that are stored as coordinates are not updated when you change a target/antenna height record in the database.

---

A change in antenna height does not affect any postprocessed points that will be processed using the Survey Office software. Verify the target/antenna height information when you transfer the data to the office computer or transfer postprocessed points directly from the receiver to the office software.

Some conventional measurements use calculated (system) targets, which have a zero height and zero prism constants, for example, Dual-prism offset. You cannot edit the target heights for system targets.

To edit a target/antenna record using *Review job*

1. Tap the target/antenna record. The current target (conventional survey) or antenna (GNSS survey) details appear.
2. Enter the new details.
3. Tap **Accept**.

The current record is updated with the new details, which apply to all subsequent observations using that record.

When you change a target/antenna height record, a note with a time stamp is attached to the record. This note documents the old height details, including when the changes were made.

To edit target/antenna records using *Point manager*

1. Tap  and select **Job data / Point manager**.
2. Tap **Display** and select **Target height** to show the **Target height/Antenna height** column.



3. Tap a record to select it. To select multiple records, press and hold **Ctrl** to select records from anywhere in the list, or press and hold **Shift** to select a group of records from the list.

**TIP –**

- You do not need to select contiguous target and/or antenna heights to edit.
- You cannot edit a selection of antenna heights that includes more than one type of antenna. Select and edit the points in separate groups, according to the type of antenna used.
- You can edit a selection of different targets. The new target heights are applied to each of the different targets but the target numbers remain unchanged.

4. If you have selected:

- one record, the point details screen appears.
- multiple records, tap **Edit** and then select **Targets**.

5. If you are editing the:

- target height, edit the measured target height value, the measurement method (when applicable), and the prism constant.

When measuring to the notch on a [Spectra Geospatial traverse prism base](#), tap ► and then select **S notch**.

- antenna height, edit the measured heights and the measurement method.

**NOTE** – *If your point selection included points with target heights and points with antenna heights, two edit dialogs appear – one to edit antenna heights and one to edit target heights.*

6. Tap **Accept**.

The corrected details are shown in the Point manager.

The software automatically inserts notes into the job database to record what was edited, the original measurement data, and the time of the edit. You can view the edited records and notes in **Review job**.

### To edit code records

You can review and edit code records after measuring points.

When you edit a code record, a note with a time stamp documenting the old code value is attached to the record.

If you are editing:



- a single code, use **Review job** or **Point manager**.
- codes in multiple records, use **Point manager**.

**TIP** – You can edit Descriptions in the same way.

To edit the code for a single point record using **Review job**

1. Tap  and select **Job data / Review job**.
2. Tap the observation record that contains the code you want to edit.
3. Change the code.
4. Tap **Accept**.

To edit codes in multiple point records using **Point manager**

1. Tap  and select **Job data / Point manager**.
2. Tap a record to select it. To select multiple records, press and hold **Ctrl** to select records from anywhere in the list, or press and hold **Shift** to select a group of records from the list.
3. Tap **Edit** and then select **Codes**.
4. Enter the new code(s) or tap  , select the new code and tap **Enter**.
5. Tap **OK**.

If the code has attributes, the attribute entry screen for the code appears. See [To enter attribute values when measuring a point, page 487](#).

6. Enter the attributes. Tap **Store**.

## To edit point name records

You can use the **Point manager** to edit the names of points and observations.

---

 **CAUTION** – If you change the name or coordinates of a record, or delete a point or feature record, the positions of other records that rely on that record could change or disappear. Make sure you have read the topic [Point record changes: effects on other points, page 197](#) and you understand the impact of your changes before you make them.

---

1. Tap  and select **Job data / Point manager**.
2. Tap the record or use the arrow keys to select it.

You cannot edit the name of

- points in linked files
- an observation to the current station if a survey is running
- a backsight observation

3. Tap **Edit** and then select **Point names**.
4. Edit the name.

**TIP** – If you are editing the name of a total station observation which is one of a number of total station observations to the same point name, such as observations taking when measuring rounds, select whether to rename other observations with the same name observed from the same station. If you are renaming an MTA record, then all other observations to the same point from the same station setup will be automatically renamed to match the MTA point name.

5. Tap **OK**.

Details of changes made are automatically saved to the **Note** record.

## To edit point coordinate records

You can use the **Point manager** to edit the coordinates of imported or keyed in points.

---

 **CAUTION** – If you change the name or coordinates of a record, or delete a point or feature record, the positions of other records that rely on that record could change or disappear. Make sure you have read the topic [Point record changes: effects on other points, page 197](#) and you understand the impact of your changes before you make them.

---

1. Tap  and select **Job data / Point manager**.
2. Tap the record or use the arrow keys to select it.

You cannot edit the coordinates of:

- raw observations
- points in linked files
- a range of records at one time

3. Tap **Edit** and then select **Coordinates**.
4. Edit the coordinates.
5. To change the search class for a keyed in point from **Normal** to **Control**, select the **Control point** check box. To change the search class from **Control** to **Normal**, clear the check box.
6. Tap **OK**.

Details of changes made are automatically saved to the **Note** record.

## To delete points or features



If required, you can delete points or job features (lines, arcs, or polylines) in Point manager or from the map. A deleted point or feature is not used in calculations, but it is still in the database.

---

 **CAUTION** – If you change the name or coordinates of a record, or delete a point or feature record, the positions of other records that rely on that record could change or disappear. Make sure you have read the topic [Point record changes: effects on other points, page 197](#) and you understand the impact of your changes before you make them.

---

The search class for deleted points changes to Deleted (normal), Deleted (control), Deleted (staked), Deleted (backsight), or Deleted (check), depending on the original search classification.

When you delete a point or feature, the symbol used for the point or feature record changes to indicate it has been deleted. For example, for a topo point, the  symbol replaces the  symbol. The software records a note with the original point or feature record, showing the time it was deleted.

#### To delete a point or feature record

1. Tap  and select **Job data / Point manager**.
2. Select the point or feature record to be deleted and tap **Details**.
3. Tap **Delete**.
4. Tap **Accept**.

#### To restore a point or feature record

1. Tap  and select **Job data / Point manager**.
2. Tap the point or feature record to be restored.
3. Tap **Undelete**.
4. Tap **Accept**.

#### To delete features from the map

1. Select the required feature(s) using one of these options:
  - Tap the feature(s).
  - Drag a box around the feature(s).
  - Tap and hold on the screen and tap **Select**.

You can only delete points, lines, arcs, or polylines that are in the job database. You cannot delete points or features from a linked map file (for example, a DXF or SHP file).

2. Tap and hold on the screen and select **Delete**.
3. Tap **Delete**.

#### Point record changes: effects on other points

The Origin software uses a dynamic database. If you change the name or coordinates of a record, the positions of other records that rely on that record could change or disappear. Deleting a record can result in null coordinates for records that rely on the deleted record.

If you select a range of records and change their name, all the selected records are renamed to the new name that you entered.

If you rename or edit the coordinates of points, all records that contain computed deltas to other points, for example as-staked, check, and backsight observations, are not updated.

#### Base station or station setup positions

If you rename a point name that is used as a base in a GNSS survey, or as a station setup point in a conventional survey, this does not rename the point name that is referenced in the Base record or Station setup record. You cannot edit the point name referenced in the Base record or Station setup record.

If you rename the base position or station setup position, and another record with the same name

- **does not** exist, then the positions of all records that are computed from that base position or station setup position cannot be computed, and those records will no longer be displayed in the map.
- **does** exist, then the positions of all records that are computed from that base position or station setup position may change, as they will be computed from the next best point with the same name.

If you edit the base position or station setup position, then the positions of all records that are computed from that base position or station setup position will change.

If you edit the azimuth in an a station setup with a keyed-in azimuth to the backsight, then the positions of all records that are computed from that station setup will change.

#### Backsight positions

If you edit or rename the point record that is used as a backsight in a station setup with a computed azimuth to the backsight, then the positions of all records that are computed from that station setup may change.

#### Changes to other positions

Changes to resections, lines, arcs, compute inverse records, and others may also affect other positions. Refer to the table below, where the \* symbol shows the database records that may change if the name or the coordinates of the record that was used to derive their position is modified.

Record	Names	Coordinates
Topo points (GNSS)	*	*
Rapid points	*	*

Record	Names	Coordinates
FastStatic points	*	*
Observed control points	*	*
Face 1 Topo points (Conv.)	*	*
Face 2 Topo points (Conv.)	*	*
Mean turned angle	*	*
As-staked points	*	*
Check points	*	*
Continuous points	*	*
Construction points	*	*
Laser points	*	*
Lines	*	*
Arcs	*	*
Compute inverse	*	*
Resection points	-	-
Adjusted points	-	-
Averaged points	-	-
Cogo points (computed) (see note below)	* 1	* 1
Intersection points	-	-
Offset points	-	-
Roads	-	-
Alignments	-	-
Calibration points	-	-
Compute area	-	-

1 - Cogo points can change if the point they are computed from is modified, but it depends on how the Cogo points were stored. If they were stored as a vector, for example Az HD VD and the base point is moved, then the Cogo point will also move.

## Deleted items

A deleted point, line, arc, or polyline is not used in calculations, but it is still in the database.

Deleting points, lines, arcs, or polylines does not make a job file smaller.

Some points, such as continuous offset points and some intersection and offset points, are stored as vectors from a source point. If you delete a source point, any point stored as a vector from that point has null (?) coordinates when you review the database point record.

When you delete an observation that has been recorded during a [Station setup plus](#), a [Resection](#), or [Measure rounds](#) operation, the mean turned angle records and station or round residuals records will not be updated. Deleting an observation that has been used to compute an average does not automatically update the average. Use **COGO / Compute average** to recompute the average.

You cannot delete points from a linked file.

Use File Explorer to delete alignment files, road files, map files, or any other file type stored on the controller.

## Managing points with duplicate names

This topic explains the **database search rules** applied by the software when managing points of the same name.

If you configure the **Duplicate point tolerance** options in the survey style to allow points of the same name in the job, then make sure you are familiar with these rules. If your job does not contain points of the same name, then the search rules are not used.

## Dynamic database

The Origin software includes a dynamic database. This stores networks of connected vectors during RTK and conventional surveys, making the positions of some points dependent on the positions of others. If you change the coordinates of a point that has dependent vectors (for example, an instrument station, a backsight point, or a GNSS base station), this affects the coordinates of all points that depend on it.

**NOTE** - *Editing the name of a point that has dependent vectors can also affect the coordinates of points that depend on it. If you change the point name, the following could occur:*

- *positions of other points could become null*
- *if another point with a matching name exists, that one could be used to coordinate the dependent vectors*

The software uses database search rules to resolve the coordinates of dependent points, based on the new coordinates for a point they depend on. If the coordinates of a point with dependent points move by a certain amount, the dependent points are shifted by the same amount.



When two points of the same name exist, the software uses search rules to determine the best point.

### Search rules

The software lets multiple points with the same point name (point ID) exist in the same job.

To distinguish between points of the same name and to decide how these points are to be used, the software applies a set of search rules. When you ask for the coordinates of a point in order to perform a function or calculation, these search rules examine the database according to:

- the order in which the point records were written to the database
- the classification (search class) given to each point

### Order in the database

A database search starts at the beginning of the job database and works down to the end of the job, looking for a point with the specified name.

The software finds the first occurrence of a point of that name. It then searches the rest of the database for points of the same name.

The rules generally followed by the software are:

- If two or more points have the same class and the same name, it uses the first point.
- If two or more points have the same name but different classes, it uses the point of higher class, even if this is not the first occurrence of the point.
- If two or more points (one from the job database and one from an attached linked file) have the same name, the software uses the point in the job database, regardless of the classification of the point in the linked file. However, you can add points to a stakeout list from the linked file using the **Select from file** option, and the point from the linked file will be used even when the point already exists in the current job. For more information, see [Linked files and their search rules](#).

### Search class

The software gives most **Coordinates** and **Observations** a classification. It uses this classification to determine the relative importance of points and observations stored in the job database.

Coordinates have priority over Observations. If a Coordinate and an Observation of the same name have the same class, the Coordinate will be used regardless of its order in the database.

## Coordinate classes

The **Coordinate Classes** are arranged in a descending hierarchy, as follows:

- Control – (the highest class) can only be set when a point is keyed in or transferred.
- Averaged – is given to grid positions stored as a result of an average position computation.
- Adjusted – is given to points that are adjusted in a traverse computation.
- Normal – is given to keyed-in and copied points.
- Construction – is given to all points measured using Fastfix, which are typically used in the computation of another point.
- Deleted – is given to points that have been overwritten, where the original point had the same (or a lower) search class than the new point.

Deleted points are not displayed in point lists and they are not used in calculations. However, they do remain in the database.

## Control class

Control class is used in preference to other coordinate classes. It can only be set by you. Use control class for points that you want to use in preference to points of the same name in the same job database. See [Assigning control class to a point](#).

**NOTE** – *You cannot overwrite a control class point with a measured point, or use a control class point in an average position computation.*

In general, if there are multiple observations with the same name, the best point is determined by the point that has the highest classification.

## Observation classes

The **Observation Classes** are arranged in a descending hierarchy, as follows:

- Mean Turned Angle (MTA) \*, Normal, Backsight, and Stakeout
- Construction
- Check
- Deleted

Deleted observations are not displayed in point lists and they are not used in calculations. However, they do remain in the database.

If there are multiple observations of the same name which also have an equivalent classification (that is, normal and backsight are equivalent), then the best is the one that is found first in the database.

\* Within a single station setup, a Mean Turned Angle observation is better than all the other classes – it is treated as an equivalent classification to the other classifications that are listed only when the observations appear in different station setups.

### Example

If a point named "1000" is entered as the start point when calculating a from-a-baseline offset, the software searches for the first occurrence of point "1000". It then searches the rest of the database for any point named "1000", under the following rules:

- If no other point of this name is found, it uses the one it has to calculate the offset.
- If another point "1000" is found, the software compares the classes of the two points. It uses the point "1000" that has the highest classification. Remember that a Coordinate class point (for example, keyed-in) is higher than an Observation class point.

For example, if both points were keyed in, one was given a normal classification and the other a control classification, the Origin software uses the control class point to calculate the offset, regardless of which record the search finds first. If one point was keyed in and one was observed, the Origin software uses the keyed-in point.

- If the points are of the same class, the Origin software uses the first one. For example, if both points named "1000" were keyed in, and both were given a normal classification, the first one is used.

### Exceptions to the search rules for GNSS surveys

Normal search rules are not used in the following situations:

- In a GNSS calibration

Calibration searches for the highest class point stored as grid coordinates. This grid point is used as one of a pair of calibration points. The software then searches for the highest class GNSS point stored as **Global** coordinates or as a **Global** vector. This point is used as the GNSS part of the point pair.

- When starting an RTK rover

When you start a rover survey, if the broadcast base point is called, for example, "BASE001", choosing **Start survey** causes the software to search for the highest class GNSS point of that name stored as **Global** coordinates. If there is no GNSS point stored as **Global** coordinates, but "BASE001" exists stored as grid or local coordinates, the software converts the grid or local coordinates of the point into **Global** coordinates. It uses the projection, datum transformation, and current calibration to calculate the point. It is then stored, as "BASE001", with **Global** coordinates and is given a check class classification so that the original grid or local coordinates will still be used in calculations.

**NOTE** – *The **Global** coordinates of the base point in the database are the coordinates from which GNSS vectors are solved.*

If there is no base point in the database, the position broadcast by the base receiver is stored as a normal class point and it is used as the base coordinates.

#### Exceptions to the search rules for conventional surveys

Normal search rules are not used in the following situations:

- Face 1 or face 2 from one station setup and an MTA from another station setup

If you observe a point on more than one face, the face 1 observation and the face 2 observation are combined to create an MTA record. In this situation, the MTA is used to coordinate the point. However, if there is an observation to a point on face 1 or face 2 only, from an earlier station setup, and later a station setup (that could be at the same station as the first) to that same point creates a new MTA, then the MTA is deemed to be of the same class as the earlier face 1 or face 2 observation. In this situation, the order in the database rule is invoked, and the first point in the database is deemed the best point.

- Observations that coordinate a point are better than those that do not

An angles and distance observation that coordinates the point, is better than an angles-only observation that does not coordinate a point. This rule applies even when the angles-only observation is earlier in the database, and is of a higher class, for example, an MTA.

## Linked files and their search rules

Comma Delimited (\*.csv or \*.txt) files or (job) files can be linked to the current job to access external data.

The search rules do not operate across linked files. Points in the current job are **always** used in preference to a point of the same name in the linked file, regardless of the classification. For example, if point 1000 in the current job has an As-staked classification, and point 1000 in a linked job file has a Normal coordinate classification, then the search rules will select the As-staked class point in preference to the Normal class point. If both points were in the current job, then the search rules would select the Normal class point.

**NOTE** – *You can add points to the stakeout list using the **Select from file** option even if the point in the linked file already exists in the current job. When a point of the same name exists in the current job, this is the only way that you can stake a point from a linked file.*

When points of the same name exist in a single CSV file, the software uses the first point.

When points of the same name exist in multiple CSV files, the software uses the point in the first CSV file. The first CSV file is the first one in the file selection list. To change the order of the CSV files, tap the tabs at the top of the file selection screen. If you change the order of the CSV files, this may change the order in which files are selected.

When you accept a CSV file selection, and you then go back and select more CSV files, all subsequent files are appended to the initial selection, using the rules. This assumes that the original selection is not altered.

Spectra Geospatial recommends that you do not use multiple CSV files that contain points of the same name.

## Finding the best point in the database

To find the point with the highest classification, use the **Point manager**. In the **Point manager**, the highest class point always appears at the first level in the tree structure. If there is more than one point of the same name, the tree structure has a second level, which contains all points of the same name. The point with the highest classification appears at the top, followed by the other points of the same name, in the order in which they were observed.

## Duplicate point tolerance settings and overwriting

Duplicate point tolerance settings are configured in the survey style. When storing points, these settings are used to compare the coordinates of the point to be stored with points of the same name that already exist in the database. If the coordinates are outside the duplicate point tolerances defined in the survey style, the **Duplicate point out of tolerance** dialog appears.

**NOTE** – This warning appears only if the new point is out of tolerance with the original point. If you have changed the tolerance values, the message may not appear. See [Duplicate point tolerance options, page 362](#).

Of the options displayed in the **Duplicate point out of tolerance** dialog, **Overwrite** and **Average** are the only two options that might result in a point being 'promoted' – thus changing the coordinates for the best point.

In a conventional survey, observations from one station setup to the same point are combined to create an MTA record. You do not see the "duplicate point out of tolerance" warning.

If you store a face 2 observation to a point that already has a face 1 observation, the face 2 observation is checked to see if it is within tolerance of the face 1 observation and then stored. For more information about face 1 and face 2 observations, see [Measuring a point in two faces](#).

### The overwrite rules

Overwrite deletes points, and results in a change to the coordinates of the best point. Deleted points remain in the database and have a search class of Deleted. See [Search class](#).

If the **Overwrite** option does not appear in the software, this means that an overwrite would not result in changes to the coordinates of the best point.

Select **Overwrite** to store the new point and delete all existing points of the same class or below:

- Observations can overwrite and therefore delete Observations.
- Coordinates can overwrite and therefore delete Coordinates.
- Observations cannot overwrite Coordinates.
- Coordinates cannot overwrite Observations.

One exception to these rules is when a Rotate, Scale or Translation is performed. When one of these transformations is applied, the original observations are deleted and replaced by the translated points.

That does not mean that all Observations can overwrite all other Observations of the same name, and all Coordinates can overwrite all Coordinates of the same name. The [Search class](#) rules still apply.

### Overwrite examples

- If you measure a point with a name that already exists in the database, you can choose to overwrite it when you store the new one. All previous Observations of the same name, and with the same or a lower search class, are deleted.

If a point stored as a Coordinate existed, then overwrite would not have been an option, because overwriting the observations would not have changed the best point.

- If you key in a point with a name that already exists in the database, you can choose to overwrite it when you store the new one. All previous points stored as Coordinates, of the same name, and with the same or a lower search class, are deleted. Points of the same name stored as Observations are not affected.

### Storing another does not change the best point

If you measure or key in a point with a name that already exists in the database, you can choose to store both points in the database, and both are transferred with the job. The Origin search rules ensure that the point with the highest class is used for calculations. If there are two points of the same class, the **first** is used.

### Averaging overwrites another average

If you measure a point and use a name that already exists in the current job, you can choose to average all points of that name. To store the observation and an averaged grid coordinate, select **Average**. Where an averaged position of that name already exists, the new averaged position will overwrite the existing averaged position. Averaged points have a coordinate classification. Coordinates have a higher classification than observations, so the stored averaged position is used in preference to any observations. You can also choose to Auto-average when the point is within tolerance. See [Auto average tolerance, page 362](#).

### Assigning control class to a point

Control class is the highest classification that you can give to a point. Any high-accuracy point that you use as a fixed standard in a job can be a control point.

If you specify control search class when you key in the coordinates for a point, you can be sure that those coordinates will not change until you key in another point of the same name and the same search class (control) and choose to overwrite the first point.

The Origin software never elevates measured points to control class. This is because measured points have measurement errors and may change or be measured again during the course of the job. If the keyed-in point "CONTROL29" is control class, generally you would not want the coordinates of that point to change. A control class point is held fixed for the job.

The Origin software can measure **observed** control points, but it does not give them control classification. This is because, in calibration, the measured point often has the same name as the keyed-in control point. This makes it easier to set up the calibration. It also makes it easier to

manage your data, for example, if you know that all references to point "CONTROL29" on the ground are also references to point "CONTROL29" in the database.

### Point storage and classification

How you record a point determines how it is stored in the Origin software. Points are stored either as vectors or as positions. For example, RTK points and conventionally observed points are stored as vectors, while keyed-in points, real-time differential points, and postprocessed points are stored as positions.

To review details about a stored point, tap  $\equiv$  and select **Job data / Review job**. A point record contains information about the point, such as the point name, the code, the method, the coordinates, and the GNSS data file name. The **Method** field describes how the point was created.

The coordinates are expressed as Global, local, or grid coordinates, depending on the setting in the **Coordinate view** field.

To change the coordinate view settings, do one of the following:

- From the **Job data** menu, tap **Review job**. Open the point record and then tap **Options**.
- From the **Key in** menu, tap **Points** and then tap **Options**.

**NOTE** – Define a datum transformation and/or a projection if you want to display local or grid coordinates for a GNSS point. Alternatively, calibrate the job.

Each point record uses the antenna height given in the previous antenna height record. From this, the software generates a ground height (elevation) for the point.

The following table shows how the point is stored in the **As Stored** field.

Value	What the point is stored as
Grid	Grid coordinates
Local	Local geodetic coordinates
Global	View as <b>L, L, H</b> coordinates in the <b>Global reference datum</b> at the <b>Global reference epoch</b> .
ECEF (Global)	View as Earth-Centered, Earth-Fixed <b>X, Y, Z</b> coordinates in the <b>Global reference datum</b> at the <b>Global reference epoch</b> .
ECEF deltas	View as an Earth-Centered, Earth-Fixed <b>X, Y, Z</b> vector in the <b>Global reference datum</b> at the <b>Global reference epoch</b> .
Polar	Azimuth, horizontal distance, and vertical distance. This is a vector.
HA VA SD	A horizontal circle reading, vertical circle reading (a zenith angle), and slope distance. This is a vector.



Value	What the point is stored as
HA VA SD (raw)	A horizontal circle reading, vertical circle reading (a zenith angle), and slope distance with no corrections applied. This is a vector.
Mag.Az VA SD	A magnetic azimuth, vertical (zenith) angle, and slope distance vector.
MHA MVA MSD	A meaned horizontal angle from the backsight, meaned vertical angle (a zenith angle), and meaned slope distance. This is a vector.
USNG/MGRS	USNG/MGRS string and elevation

Read the **As Stored** field in conjunction with the **Method** field.

The **Global reference datum** and the **Global reference epoch** are shown in the **Select coordinate system** screen of the job properties. See [Coordinate system, page 73](#).

For points calculated using **Cogo/Compute point**, you can choose how to store that point. The available options depend on the selected coordinate system and the type of observation used in computing the point.

**NOTE** – *Points stored as vectors are updated if the calibration or coordinate system of the job changes, or the antenna height of one of the source points is changed. Points stored as Global coordinates (for example, an offset point calculated using the **From a baseline** method) are not updated.*

For GNSS points, Quality Control (QC) records are stored at the end of the point record.

#### Point classification

When points are stored they have either one or two classifications:

- Points that have been measured using GNSS have an observation class and a search class.
- Points that have been keyed in, computed, or measured with a conventional instrument or laser rangefinder have only a search class.

#### Observation class

The following table lists the observation classes and resulting solutions.

Observation class	Result
RTK	A real-time kinematic solution.
L1 Fixed	An L1 fixed real-time kinematic solution.
L1 Float	An L1 float real-time kinematic solution.

Observation class	Result
L1 Code	An L1 code real-time differential solution.
Autonomous	A postprocessed solution.
SBAS	A position that has been differentially corrected using SBAS signals.
Network RTK	A real-time kinematic solution using Network RTK.
RTX	A position that has been generated by the Trimble Centerpoint RTX correction service.
WA Fixed	A fixed solution using wide-area processing.
WA Float	A float solution using wide-area processing.

**NOTE** – For postprocessed surveys, the observation class is autonomous and no precisions are recorded.

### Search class

A search class is applied to a point when it is measured, keyed in, or computed. The search class is used by the software when details of a point are required for stakeout or calculations (for example, for Cogo calculations). See [Database search rules](#).

### Coordinate view settings

You can change the **Coordinate view** settings when viewing a point in the **Review job** screen or the **Point manager** or when keying in a point.

### Available coordinate view options

Option	Description
Global	View as <b>L, L, H</b> coordinates in the <b>Global reference datum</b> at the <b>Global reference epoch</b>
Local	View as local ellipsoidal latitude, longitude, and height.
Grid	View as northing, easting, and elevation.
Grid (local)	View as northing, easting, and elevation relative to a transformation.
ECEF (Global)	View as Earth-Centered, Earth-Fixed <b>X, Y, Z</b> coordinates in the <b>Global reference datum</b> at the <b>Global reference epoch</b> .
ITRF 2014	View as <b>X, Y, Z</b> , and <b>T</b> (time/epoch of measurement) coordinates in the ITRF 2014 reference frame.

Option	Description
Station and Offset	View as station, offset, or vertical distance relative to a line, arc, alignment, or road.
Az VA SD	View as azimuth, vertical angle, and slope distance.
HA VA SD (raw)	View as horizontal angle, vertical angle, and slope distance.
Az HD VD	View as azimuth, horizontal distance, and vertical distance.
HA HD VD	View as horizontal angle, horizontal distance, and vertical distance.
Delta Grid	View as differences in northing, easting, and elevation from the instrument point.
USNG/MGRS	View as USNG/MGRS string (based on the local ellipsoid) and elevation.

**NOTE -**

- The **Global reference datum** and the **Global reference epoch** are shown in the **Select coordinate system** screen of the job properties. See [Coordinate system, page 73](#).
- When keying in a point, and for all options except **Grid** or **Grid (local)**, the computed grid coordinates are also displayed. To select **Grid (local)**, the **Advanced Geodetic** option must be enabled in the **Cogo settings** screen.

## Null coordinate values

If the coordinate value when viewing a point is **?**, one of the following situations may have occurred:

- The point may be stored as a GNSS point but with the **Coordinate view** field set to **Local** or **Grid** and a datum transformation and projection not defined. To correct this, change the **Coordinate view** setting to **Global**, define a datum transformation and/or projection, or calibrate the job.
- The point may be stored as a **Grid (local)** point and with the **Coordinate view** field set to **Grid**, but a transformation has not been defined to convert the **Grid (local)** to a **Grid**.
- The point may be stored as a polar vector from a point which has been deleted. To correct this, restore the point.
- In a 2D survey, a projection may have been defined with the project height as null. To correct this, set the **Project height** to approximate the site elevation.

To view Grid (local) coordinates

**NOTE** – To select **Grid (local)**, the **Advanced Geodetic** option must be enabled in the **Cogo settings** screen.

1. In **Point manager** or **Review job**, tap **Display** and then select **Grid (local)**.
2. To select the Grid (local) transformation for coordinate display, or to create a transformation, select **Options**.
3. Do one of the following:
  - To view the original Grid (local) values, select **Display original grid local** and then tap **Accept**.
  - To create a new display transformation, select **Create new transformation**. Tap **Next** and complete the required steps. See [Transformations, page 261](#).
  - To select an existing display transformation, select **Select transformation**. Select the display transformation from the list. Tap **Accept**.

**NOTE –**

- The 'input' transformation transforms a point from the original entered Grid (local) coordinates to database grid coordinates.
- The 'display' transformation transforms a point, regardless of how it was stored, from the database grid coordinates to display computed Grid (local) coordinates.
- When viewing the original Grid (local), points not stored as Grid (local) appear as null North (local), East (local), and Elev (local).
- When you select a display transformation, all database grid points appear using the current display transformation. If the display transformation is different from the original transformation, the computed Grid (local) coordinates are different from the original entered Grid (local) coordinates. To see the original Grid (local) coordinates, set the **Coordinate view** to **As Stored. Transformation (as stored)** is displayed when reviewing Grid (local) and the **Coordinate view** is set to **As Stored. Transformation (display)** is displayed when reviewing Grid (local) and the **Coordinate view** is set to **Grid (local)**.
- A point entered as a Grid (local) point is stored in its original format to the job as a Grid (local) point. Typically, the input transformation to transform the point to a database grid point is assigned at the time the point is entered, but the transformation can be created later and then assigned to the point(s) using **Point manager**.

To view coordinates by station and offset

To view points by station and offset relative to an item such as a line, arc, polyline, alignment, or road:

1. Tap  and select **Job data / Point manager**.
2. Tap **Display** and then select **Station and offset**.
3. Tap **Options**.
4. Select the item **Type** and the item name. If you select **Road** in the **Type** field, then you must select the **Road format** before you select the **Road name**.
5. Tap **Accept**.

If the **Coordinate view** is set to **Station and offset** relative to a road or alignment, then the station and offset for the point is to the intersection point of two horizontal alignment elements when:

- the horizontal alignment includes consecutive elements that are non tangential;
- the point is beyond the end tangent point of the incoming element but before the start tangent point of the next element; and
- the point is on the **outside** of the horizontal alignment.

The exception to this behavior is if the distance from the point to the intersection point is greater than the distance to another element in the horizontal alignment. In that case, the station and offset for the point is to the closer element.

Where the point is on the **inside** of the horizontal alignment, then the station and offset is relative to the closest horizontal element.

Where the point is before the start of the horizontal alignment or beyond the end of the alignment, the station and offset for the point is null.

To change the term used for distances in the software to **Chainage** instead of the default **Station**, tap  and select **Settings / Language**.

## Data quality graph

The **QC graph** screen displays a graph of quality indicators that are available from data in a job. To change the type of data to display, tap **Display**. To scroll along the graph, use the arrow buttons. To view basic details of a point, tap the graph. For more information, double tap the graph to access **Review**.

You can view a graph of:

- Horizontal precision
- Vertical precision
- Tilt distance
- Satellites
- PDOP
- GDOP
- HA standard error
- VA standard error

- SD standard error
- Elevation
- Target height
- Attributes

**NOTE** – *Attributes can be filtered by **Feature code** and **Attributes** but only feature codes that contain numeric or integer attributes are displayed.*

Tap a point to see details for that point. Tap again to review the point.

To aid point selection, tap a point and then tap **Prev** or **Next** to select the previous or next point.

To add a note to a point, tap the bar in the graph to select the point, and then tap the **Note** softkey.

To navigate to a point, tap the point and swipe right to left along the row of softkeys and then tap **Navigate**.

To define the Y axis range, tap near the Y axis and from the pop-up menu define the **Minimum** and **Maximum** Y axis values.

## Key in & Cogo

To create entities such as points, lines, arcs, or polylines use the functions available from the **Key in** menu or the tap and hold menu in the map.

To change coordinate geometries or to compute coordinate values, use the functions available from the **Cogo** menu or the tap and hold menu in the map.

### Construction points

Typically, a construction point is used in Cogo functions or when keying in lines, arcs, or polylines.

To quickly measure and automatically store a construction point, tap ► next to the **Point name** field in the Cogo or Key in screen and then select **Fast fix**:

- In a conventional survey, wherever the instrument is pointing, that position is stored.
- In a real-time GNSS survey, **Fast fix** uses the **Rapid point** method.

Construction points are stored in the database with autopoint names that increment from Temp0000. They are classified higher than check points and lower than normal points. For more information, see [Database search rules](#).

To view construction points in a map or list, Tap ⌘ in the **Map** toolbar to open the **Layer manager**. Select the **Filter** tab and make sure construction points are set to selectable. See [To manage data filters, page 123](#).

### Keying in data

Use the **Key in** menu to enter coordinates for new points from the keypad.

You can also access some key in methods from the tap and hold menu in the map.

The selected **Key in** screen appears alongside the map. To select points, enter the point name or tap in the appropriate field in the **Key in** screen and then tap the point in the map. For other ways to select points, tap ► and select an option. See [To enter a point name, page 112](#).



## To key in points

1. To open the **Key in point** screen, do one of the following:
  - Tap  and select **Key in / Points**.
  - In the map, tap and hold the location for the point and then select **Key in point**.
2. Enter the **Point name** and, if required, the **Code**.
3. Enter the coordinate values. To configure the **Coordinate view** settings, tap **Options**.
4. If you key in a **Station and offset** value, select from the **Type** field the item the station and offset values are relative to.
5. If you key in a **Grid (local)** value, select or create the transformation to apply. To define the transformation later, select **None**.
6. To set the search class for the point to **Control**, select the **Control point** check box. Leave the check box unselected to set the search class to **Normal**.

You can change the search class after the point has been stored using the **Point manager**.
7. Tap **Store**.

**TIP** – When keying in points from the map:

- If you are keying in multiple points, for each point you can tap in the **Northing** or **Easting** field in the **Key in point** form and then tap in the map to define the coordinates for the point. The **Coordinate view** option must be set to **Grid** or **Grid (local)**. **Grid (local)** is available only when the **Advanced geodetic** option is enabled.
- If the map is in **Plan** view (2D), the **Elevation** field is set to null (?), and a value is optional. If the map is in one of the 3D views, the value in the **Elevation** field is calculated with reference to the ground plane, surface or IFC file. You can edit this value if required.
- The **Key in point** option is not available from the tap and hold menu if you are viewing the map in 3D and the map does not include a ground plane or surface.
- If the **Coordinate view** option is set to **Station and offset** and the **Type** is set to **Road**, then if the road format is:
  - **RXL** or **GENIO** and the point is on the road, a **V.Dist** value is applied relative to the elevation at the entered station and offset. If the point is off the road you can enter an elevation.
  - **LandXML** and the point is either on or off the road you can enter an elevation.
- If the **Coordinate view** option is set to **Station and offset** and the **Type** is set to **Tunnel**, then if the tunnel has templates assigned the **V.Dist** value is always applied relative to the elevation of the vertical alignment at the entered station.

To key in a line

1. Tap  and select **Key in / Line**.

Alternatively, if you are creating a line from two points, you can select the points in the map and then from the tap and hold menu select **Key in line**.

2. Enter the name of the line and, if required, the code for the line.
3. Select the point(s) to define the line. See [To enter a point name, page 112](#).

4. Define the line using one of the following methods:

- [Two point method, page 219](#)
- [Bearing-distance from a point method, page 219](#)

5. Tap **Calc.**

6. Tap **Store.**

#### Two point method

1. In the **Method** field, select **Two points**.
2. Select the start point **(1)** and end point **(2)**.

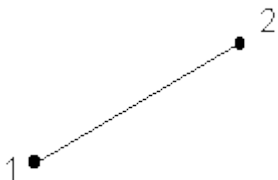

3. Enter values for the **Start station** and the **Station interval**.

#### Bearing-distance from a point method

1. In the **Method** field, select **Brng-dist from a point**.
2. Enter the name of the start point **(1)**, the azimuth **(2)**, and the length of line **(3)**.

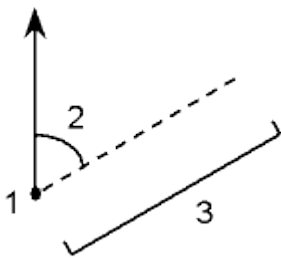

3. Enter the **Grade** between the start and end points.
4. To change how distances are calculated, tap **Options**. See [Cogo settings, page 99](#).
5. Enter values for the **Start station** and the **Station interval**.

## To key in a polyline

Polylines are two or more lines or arcs connected together.

1. Tap  and select **Key in / Polyline**.

Alternatively, you can select the points, lines, arcs, or other polylines in the map from which to create a new polyline and then, from the tap and hold menu, select **Key in polyline**.

2. Enter the **Polyline name**.
3. If required, enter the **Code** for the polyline.
4. Enter the **Start station** and **Station interval**.

5. To enter the point names that define the polyline:

Enter...	To...
1,3,5	Create a line between points 1 to 3 to 5
1-10	Create lines between all points from 1 through 10
1,3,5-10	Create a line between points 1 to 3, to 5, and 5 through 10
1(2)3	Create an arc between points 1 and 3, through point 2

1(2,L)3 Create an arc that turns to the left from the start point (1) to the end point (3), with point 2 as the center point.

The direction (L or R) defines whether the arc turns to the left (counterclockwise) or right (clockwise) from the start point (1) to the end point (3).

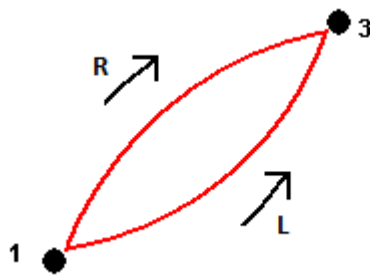

Enter...	To...
1(100,L,S)3	<p>Create a small arc with a radius of 100 that turns to the left from the start point (1) to the end point (3).</p> <p>The direction (L or R) defines whether the arc turns to the left (counterclockwise) or right (clockwise) from the start point <b>(1)</b> to the end point <b>(3)</b>.</p> <p>The size L (large) or S (small) defines the size of the arc.</p>

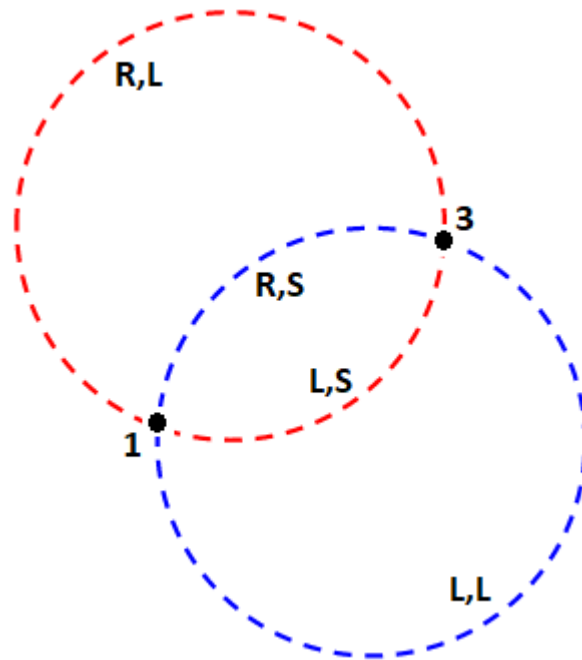

6. Tap **Store**.

#### To key in an arc

1. Tap  $\equiv$  and select **Key in / Arcs**.
2. Enter the arc name and, if required, the code for the arc.
3. Define a new arc using one of the following methods.
4. To change how distances are calculated, tap **Options**. See [Cogo settings, page 99](#).

5. Tap **Calc.**
6. Tap **Store.**

#### Two points and radius method

1. In the **Method** field, select **Two points and radius.**
2. Select the start point **(1)** and end point **(2)**, and enter the radius **(3)** of the arc.

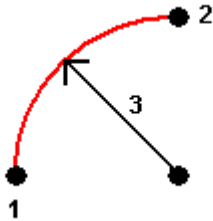

3. Specify the direction of the arc.
4. Enter values for the **Start station** and the **Station interval.**
5. If required, select the **Store center point** check box and then enter a point name for the centre point.

#### Arc length and radius method

1. In the **Method** field, select **Arc length and radius.**
2. Select the start point **(1)**, the back tangent **(2)**, the radius **(3)** and the length of the arc.

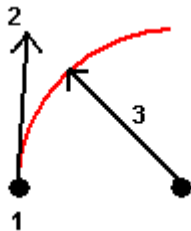

3. Specify the direction of the arc and the grade between the start and end points.
4. Enter values for the **Start station** and the **Station interval.**
5. If required, select the **Store center point** check box and then enter a point name for the centre point.

### Delta angle and radius method

1. In the **Method** field, select **Delta angle and radius**.
2. Enter the name of the start point **(1)**, the back tangent **(2)**, the radius **(3)** and the turned angle **(4)** of the arc.

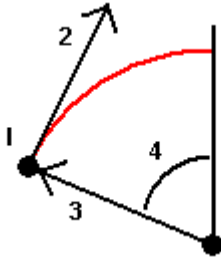

3. Specify the direction of the arc and the grade between the start and end points.
4. Enter values for the **Start station** and the **Station interval**.
5. If required, select the **Store center point** check box and then enter a point name for the centre point.

### Intersect point and tangents method

1. In the **Method** field, select **Intersect point and tangents**.
2. Select the intersection point **(1)**, and enter the back tangent **(2)**, the forward tangent **(3)** and the radius **(4)** of the arc.

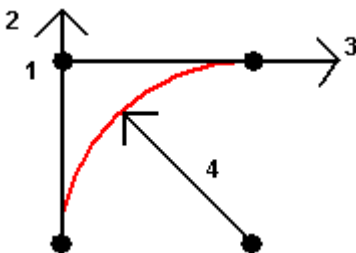

3. Enter values for the **Start station** and the **Station interval**.
4. If required, select the **Store center point** check box and then enter a point name for the centre point.



### Two points and center point

1. In the **Method** field, select **Two points and center point**.
2. Specify the direction of the arc.
3. Select the **Start point (1)**, **End point (2)**, and **Center point (3)** of the arc.

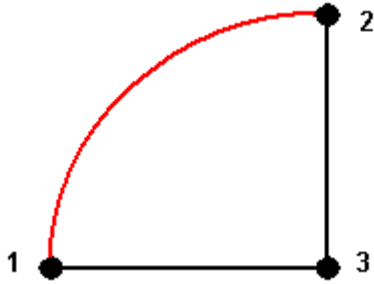

4. Enter values for the **Start station** and the **Station interval**.

### Three points method

1. In the **Method** field, select **Three points**.
2. Select the **Start point (1)**, the **Point on arc (2)**, and the **End point (3)** of the arc.

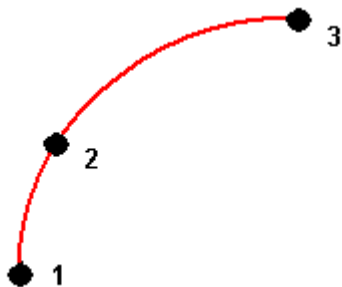

3. Enter values for the **Start station** and the **Station interval**.
4. If required, select the **Store center point** check box and then enter a point name for the centre point.

### Features of an arc

The features of an arc are indicated below.

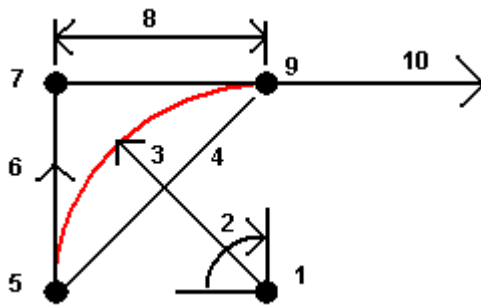

**1**

Center point

**2**

Delta angle

**3**

Radius

**4**

Chord length

**5**

From point

**6**

Back tangent

**7**

Intersection point

**8**

Tangent length

**9**

To point

**10**

Forward tangent

The back tangent value **(6)** is related to the direction (right in the above diagram) in which the station or chainage increases. For example, when you stand at the intersection point **(7)** looking in

the direction of increasing station or chainage, the forward tangent (**10**) is in front of you and the back tangent (**6**) is behind you.

The direction field defines whether the arc turns to the left (counterclockwise) or right (clockwise) from the start point (**1**) to the end point (**2**). The following diagram shows both a left (**3**) and right (**4**) arc.

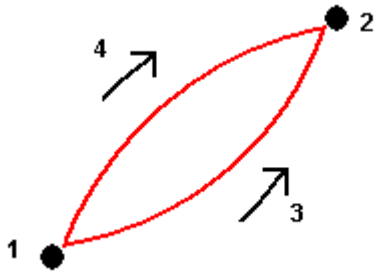

The grade of the arc is determined by the elevations of the arc start and end points.

#### To key in a note

1. To add a note to:
  - the job, tap  $\equiv$  and select **Key in / Notes**, or press **Ctrl + N** on the keypad.
  - the current record in **Review Job**, tap **Note**.
  - a point record in **Point manager**, tap in the **Note** column for the point.
2. Enter the note text. To insert a line break in the text, tap **New line**.
3. To generate a record of the current time, tap **T/Stamp**. (In portrait mode, swipe right to left along the row of softkeys to view the **T/Stamp** softkey.)
4. To enter codes from the feature library in the note, press the **Space** key *twice* in the **Note** screen. Select a code from the list or type in the first few letters of the code.
5. To attach the note to the:
  - previous point in the job, tap **Prev**.
  - next point in the job, tap **Next**.

**NOTE** - The note is stored only if another observation is stored during the current survey. If the survey ends before another observation is stored the note is discarded.

6. Tap **Store**.

## Cogo calculations

To calculate distances, azimuths, point positions and other coordinate geometry (cogo) functions by various methods use the options in the **Cogo** menu.

You can store the results of cogo functions in the job.

**TIP** – The **Snap-to** toolbar provides a simple way to select locations on objects in the map by snapping onto a specific point, even if no point exists. For example, you can use the **Snap-to** toolbar to accurately select the end point of a line or the center of an arc from linework in a map file, such as an IFC or DXF file. If a point does not already exist at the selected location, Origin calculates a point. See [Snap-to toolbar](#).

### Coordinate systems for cogo calculations

When storing points calculated from cogo functions, tap **Options** and use the **Coordinate view** field to specify if the calculated point is to be stored as **Global**, **Local** or **Grid** coordinate values. See [Coordinate view settings, page 210](#).

For some calculations, you must define a projection, or select a **Scale factor-only** coordinate system. If the points were measured using GNSS, the coordinates of the point can only be displayed as grid values if a projection and a datum transformation are defined.



**WARNING** – In general, do not compute points and then change the coordinate system or perform a calibration. If you do, these points will be inconsistent with the new coordinate system. An exception to this is points computed using the **Brng-dist from a point** method.

---

### Calculating distances

To change whether distances are displayed and calculated with reference to the ellipsoid, or to grid or ground coordinates, tap **Options** and change the selection in the **Distances** field.

If you are connected to a laser rangefinder, you can use it to measure distances or offsets. See [To measure points using a laser rangefinder, page 428](#).

### Compute point

To calculate the coordinates of an intersection point from one or more points, a line, or an arc:

1. Tap and select **Cogo / Compute point** and then select the method to use for the calculation.
2. Enter the name of the point and, if required, the code for the point.
3. Define the new point as required for the selected method:

For the **Bearing and distance** method:

- a. Select the start point **(1)**.
- b. In the **Start point** field, tap ► to select the **Radial** or **Sequential** measurement method.

When **Sequential** is selected, the **Start point** field is automatically updated to the last stored intersection point.

Radial:

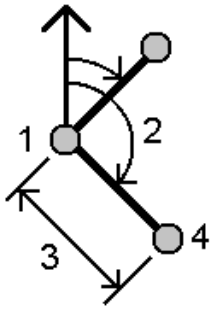

Sequential:

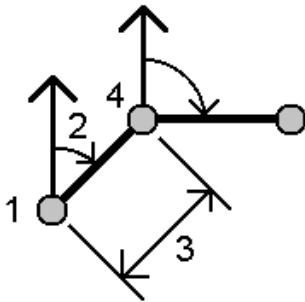

- c. Set the **Azimuth origin** to Grid 0°, True, Magnetic, or Sun (GNSS only).
- d. Enter the azimuth **(2)** and the horizontal distance **(3)**.

To adjust the azimuth value:

- In the **Azimuth** field, tap ► to adjust the azimuth by +90°, -90°, or +180°.
  - Enter a value in the **Delta azimuth** field. The **Computed azimuth** field displays the azimuth adjusted by the delta azimuth.
- e. Tap **Calc**. The software calculates the intersection point (4).
  - f. Tap **Store**.

For the **Turned angle and distance** method:

- a. Select the start point **(1)**.
- b. In the **Start point** field, tap ► to select the **Radial** or **Sequential** measurement method.

When **Sequential** is selected, the **Start point** field is automatically updated to the last stored intersection point. The reference orientation for new points moving forward is the computed reverse azimuth from the previous turned angle.

Radial:

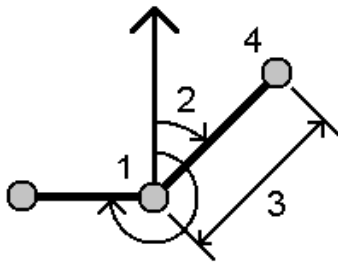

Sequential:

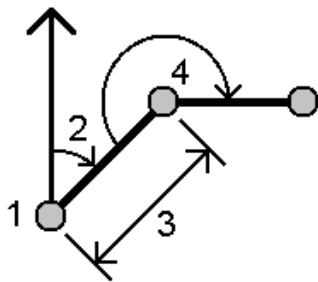

- c. To define the reference orientation:
  - a. Select the **End point**. Alternatively, tap ► in the **End point** field and select **Azimuth** and then enter the azimuth **(2)**.
  - b. Enter the **Turned angle**.
- d. Enter the horizontal distance **(3)**.
- e. Tap **Calc**. The software calculates the intersection point **(4)**.
- f. Tap **Store**.

For the **Bearing-distance intersection** method:

- a. Select point 1 **(1)** and point 2 **(3)**, and enter the azimuth **(2)** and the horizontal distance **(4)**.

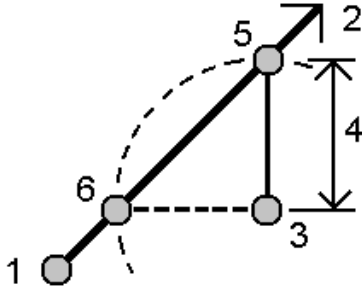

- b. Tap **Calc.** There are two solutions **(5,6)** for this calculation.
- c. To view the second solution, tap **Other**.
- d. Tap **Store**.

For the **Bearing-bearing intersection** method:

- a. Select point 1 **(1)** and point 2 **(3)**, and enter the azimuth from point one **(2)** and point two **(4)**.

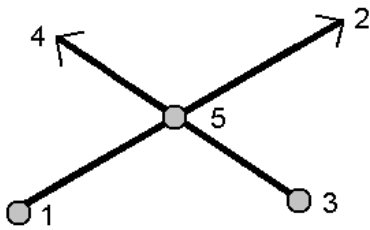

- b. Tap **Calc.** The software calculates the intersection point **(5)**.
- c. Tap **Store**.

For the **Distance-distance intersection** method:

- a. Select point 1 (**1**) and point 2 (**3**), and enter the horizontal distance from point one (**2**) and point 2 (**4**).

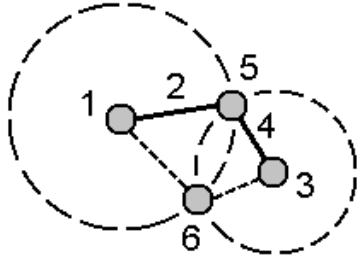

- b. Tap **Calc.** There are two solutions (**5,6**) for this calculation.
- c. To view the second solution, tap **Other**.
- d. Tap **Store**.

For the **Four-point intersection** method:

- a. Select the start point of line 1 (**1**), the end point of line 1 (**2**), the start point of line 2 (**3**) and the end point of line 2 (**4**).

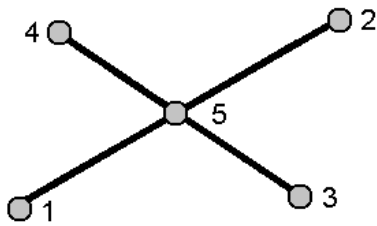

- b. Enter any change in the vertical position as a vertical distance from the end of line 2.
- c. Tap **Calc.** The software calculates the offset point (**5**).

The two lines do not have to intersect, but they must converge at some point, as shown below.

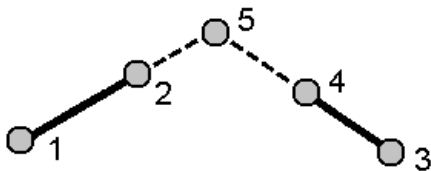

- d. Tap **Store**.



**NOTE** – If you use the **Four point intersection** method or the **From a baseline** method and then change the antenna height record for one of the source points, the coordinates of the point will not be updated.

For the **From a baseline** method:

- a. Select the start point **(1)** and the end point **(2)** of the baseline.

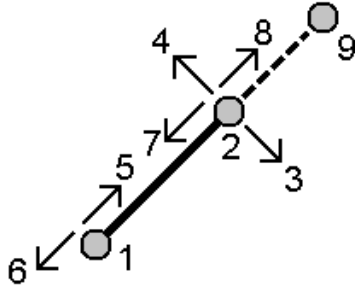

- b. Enter a **Distance** and select the **Distance direction** method (**5, 6, 7, or 8**).
- c. Enter the offset distance and select the **Offset direction**(**3 or 4**).
- d. Enter the vertical distance.

The vertical distance is dependent on the **Distance direction**. If the direction is relative to the start point, the elevation of the computed point is the elevation of the start point plus the vertical distance. Similarly, if the direction is relative to the end point, the elevation of the computed point is the elevation of the end point plus the vertical distance.

- e. Tap **Calc**. The software calculates the offset point **(9)**.

**NOTE** – If you use the **Four point intersection** method or the **From a baseline** method and then change the antenna height record for one of the source points, the coordinates of the point will not be updated.

For the **Project point to line** method:

To compute a point at a position along a line that is perpendicular to another point:

- a. Enter the **Point to project (1)**.

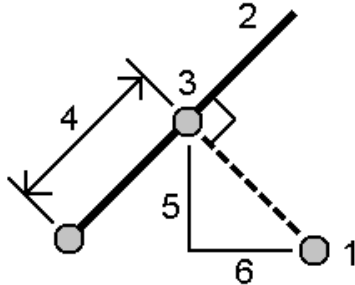

- b. Enter the **Line name(2)** or select the **Start point** and **End point** to define the line.

- c. Tap **Calc.**

The software calculates the following values:

- coordinates of the point **(3)**
- horizontal distance along the line **(4)**
- horizontal and slope distance, azimuth, grade, vertical distance, and delta north **(5)** and east **(6)** values from the selected point **(1)** to point **(3)**

- d. Tap **Store.**

For the **Project point to arc** method:

To compute a point at a position along an arc that is perpendicular to another point:

- a. Enter the **Point to project (1)**.

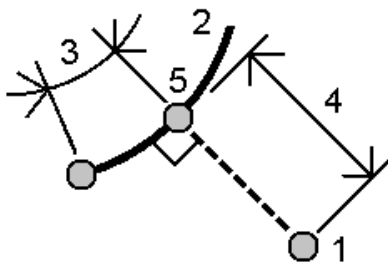

- b. Enter the **Arc name** or key in a new arc.

c. Tap **Calc.**

The software calculates the following values:

- coordinates of the point **(5)**
- horizontal distance along the arc **(3)**
- horizontal distance from the arc **(4)**

d. Tap **Store.**

**TIP –**

- When selecting reference points, select them from the map or tap ► for other selection methods. See [To enter a point name, page 112](#).
- To change how distances are calculated, tap **Options**. See [Cogo settings, page 99](#).

### Compute inverse

Use the **Compute inverse** cogo function to compute the inverse between points.

1. To open the **Computeinverse** form, you can:

- In the map, select the points and then from the tap and hold menu, select **Compute inverse**.
- Tap ≡ and select **Cogo / Compute inverse** Select the **From point(1)** and **To point(2)**. See [To enter a point name, page 112](#).

The software calculates the following values:

- azimuth **(3)**
- horizontal distance **(4)**
- the change in elevation, slope distance and grade between the two points
- delta north **(5)** and east **(6)**

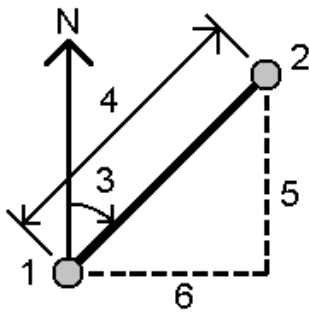

2. Tap **Store**.

### Compute distance

You can compute a distance using keyed-in data, points stored in the job, or data in a map layer. For keyed in data or points stored in the job, the compute distance results are stored in the job. For data in a map layer, compute distance results are stored as a note record.

1. To open the **Compute distance** form, you can:

- Tap  $\equiv$  and select **Cogo / Compute distance** and then select the method to use for the calculation.
- In the [calculator](#), tap **Distance**.
- In the map, select the point and the line or arc. Tap and hold in the map and select **Compute distance**.

**NOTE** - If you select two points in the map, **Compute distance** is not available from the tap and hold menu. Select **Compute inverse** instead.

2. Calculate the distance as required for the selected method:

For the **Between two points** method:

Select the **From point** and the **To point**.

The distance between the two points is calculated.

**TIP** - You can compute a distance between two points in the job directly in a distance field. To do this, enter the point names in the distance field, separated by a hyphen. For example, to compute the distance between points 2 and 3, enter "2-3". This method works with most alphanumeric point names, but it does not support point names that already contain a hyphen.

For the **Between point and line** method:

If required, enter the **Point name (1)** and the **Line name (2)**.

If the line does not already exist, tap **▶** and select **Two points**. Enter the start point and end point to define the line.

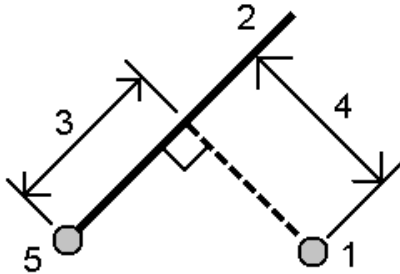

The distance along the line (**3**) and the perpendicular distance (**4**) to the line is calculated. The distance along the line is from the point specified (**5**).

For the **Between point and arc** method:

If required, enter the **Point name (1)** and the **Arc name (2)**.

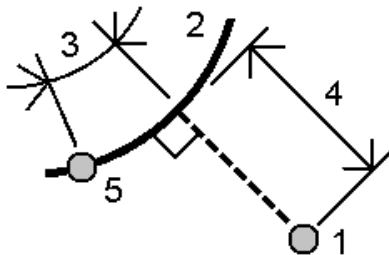

The distance along the arc (**3**) and the perpendicular distance (**4**) to the arc is calculated. The distance along the arc is from the point specified (**5**).

**TIP -**

- When selecting reference points, select them from the map or tap **▶** for other selection methods. See [To enter a point name, page 112](#).
- You can enter data in different units. For example, if you add a distance in meters to a distance in feet, the answer is returned in the format you specified in the job properties.

## Compute volume

You can calculate volumes from surfaces stored in triangulated terrain model (TTM) files.

You can import TTM files from your office software or generate them from the map in General Survey. See [To create a surface, page 173](#).

1. Tap  and select **Cogo / Compute volume**.

Alternatively, to create a surface at the same as time as computing a volume. select at least three 3D points in the map and then from the tap and hold menu, select **Compute volume**. Enter the name for the surface and tap **Accept**. The surface appears in the map.

2. In the **Compute volume** screen, select the required calculation method:

- **Above an elevation** method

Calculates the volume of a single surface above the specified elevation. Only the cut volume is computed.

- **Void volume** method

Calculates the volume of material needed to fill a surface up to the specified elevation.

- **Surface to elevation** method

Calculates the cut and fill volumes between a single surface and the specified elevation.

Where the surface is below the elevation, fill will be computed; where the surface is above the elevation, cut will be computed.

- **Surface to surface** method

Calculates the cut and fill volumes between two surfaces. The **Initial surface**, is the original surface and **Final surface** is the design surface or surface after excavation. Where the **Initial surface** is above the **Final surface**, then cut is computed; where the **Initial surface** is below the **Final surface**, then fill is computed.

**NOTE** - *Volumes are computed only in areas where the initial and final surfaces overlap.*

- **Stockpile/depression** method

This works in a similar way to **Surface to surface** except with only one surface. The selected surface is treated as the final surface and the initial surface is defined from the perimeter

points of the selected surface. Where the surface is above the perimeter surface, then cut is computed (stockpile); where the surface falls below the perimeter surface, then fill is computed (depression).

- **Surface area** method

Calculates the surface area, and using the specified depth can calculate the volume.

3. Select the surface to use.

4. If required, enter the **Haul bulkage** or **Shrinkage** factor to apply to the calculation.

A **haul bulkage** factor allows for the expansion of cut material as it is excavated. Haul bulkage is defined as a percentage. The **Adjusted cut** volume is the cut volume with the haul bulkage factor applied to it.

A **shrinkage** factor allows for compaction in fill material. Shrinkage is defined as a percentage. The **Adjusted fill** volume is the fill volume with the shrinkage factor applied to it.

5. Tap **Calc.**

After haul bulkage and/or shrinkage have been applied, the software shows the **In situ volume** (original volume) and the **Adjusted volume**:

- The **Adjusted cut volume** is the cut volume with the haul bulkage factor applied to it.
- The **Adjusted fill volume** is the fill volume with the shrinkage factor applied to it.

## Compute azimuth

You can compute an azimuth using keyed-in data or points stored in the job and store the results in the job.

1. To open the **Compute azimuth** form, do one of the following:

- Tap  and select **Cogo / Compute azimuth**.
- From the [calculator](#), tap **Azimuth**.

2. Calculate an azimuth using one of the methods below.

Between two points method

1. In the **Method** field, select **Between two points**.
2. Select the **From point (1)** and the **To point (2)**.

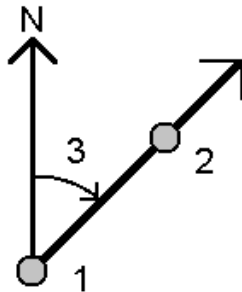

The software calculates the azimuth between the entered values **(3)**.

3. Tap **Store**.

**TIP** - You can compute an azimuth from two points in the job directly in an azimuth field. To do this, enter the point names in the **Azimuth** field, separated by a hyphen. For example, to compute the azimuth from point 2 to point 3, enter "2-3". This method works with most alphanumeric point names, but it does not support point names that already contain a hyphen.

Bisected azimuths method

1. In the **Method** field, select **Bisected azimuths**.
2. Enter values for **Azimuth 1 (1)**, and **Azimuth 2 (2)**.

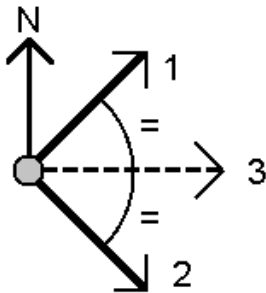

The software calculates the following values: the azimuth halfway between the entered values **(3)** and the computed angle, measured clockwise between azimuth 1, and azimuth 2.

3. Tap **Store**.



Bisected corner method

1. In the **Method** field, select **Bisected corner**.
2. Select the **Side point 1 (1)**, **Corner point (3)**, and **Side point 2 (2)**.

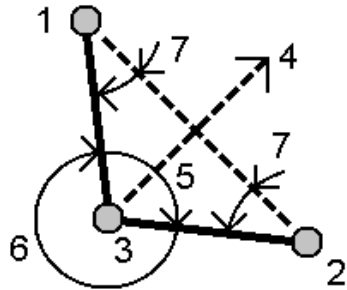

The software calculates the following values:

- azimuth **(4)**, halfway between **Side point 1** and **Side point 2**, from the **Corner point**
  - inside angle **(5)** and outside angle **(6)**
  - distance from the corner point to the two side points and the distance from one side point to the other
  - azimuth from the corner point to the two side points
  - angle between the corner point and each side point, as well as the opposite angle **(7)**
3. Tap **Store**.

Azimuth plus angle method

1. In the **Method** field, select **Azimuth plus angle**.
2. Enter the **Azimuth (1)** and the **Turned angle (2)**.

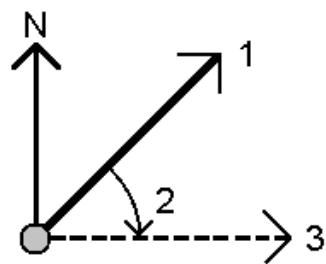

The software calculates the sum of the two values **(3)**.

3. Tap **Store**.

#### Azimuth to line offset method

1. In the **Method** field, select **Azimuth to line offset**.
2. Select the line **(1)**, and enter the station **(2)** and the horizontal offset **(3)**.

If the line does not already exist, tap **►** and select **Two points**. Enter the start point and end point to define the line.

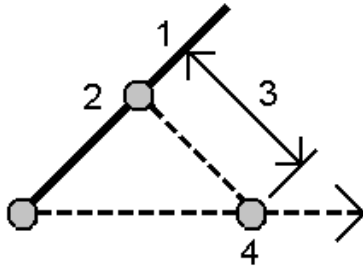

The software calculates the following values: computed azimuth **(4)**, from the start point of the line to the offset point, and the computed angle, measured clockwise between the line and the azimuth **(4)**.

3. Tap **Store**.
3. When selecting reference points, select them from the map or tap **►** for other selection methods. See [To enter a point name, page 112](#).

**TIP** – You can enter data in different units. For example, you can add an angle in degrees to an angle in radians, the answer is returned in the format you specified in the job properties.

#### Compute average

You can compute and store the averaged position for the same point if it has been measured more than once.

There are two methods available:

- **Points with the same name**

Origin allows you to **Store another** when you store a point with the same name as an existing point, and you can average these points.

**NOTE** – Points stored as control points cannot be used to compute an average using the **Points with the same name** method.

**TIP** – You can average two or more angles-only observations from two different known points only when they are measured and stored **with the same point name**.

- **Points selected in the map**

If you measure and store points at the same location but give them different names, you can calculate a new averaged point with a new name using the **Points selected in the map** method.

**TIP** – To automatically average duplicate points, enable **Auto average** in the **Duplicate point tolerance** section of the survey style.

To compute an average

1. Tap  and select **Cogo / Compute average**.
2. Select the **Method**.

For the **Points with same name** method:

- a. Select the **Point name**.
- b. In the **Code** field, enter the code to use for the averaged point.

The Origin software averages all positions in the job with the same name, except control points. Once computed, the average point grid position appears, along with the standard errors for each ordinate.

**NOTE** – *Any Mean Turned Angle (MTA) observed to the point is ignored and the original observations are used to compute the average position.*

For the **Map selected points** method:

- a. If you have not already selected the points in the map, select them by tapping each point or by drawing a box around them in the map.
- b. In the **Averaged point name** field, enter the name to use for the new averaged point.
- c. In the **Code** field, enter the code to use for the new averaged point.

The software averages the positions and the averaged point appears on the map.

3. To include or exclude specific positions from the average computation, tap **Details**.

The residuals from the average position to each individual position are shown.

4. To change the averaging method, tap **Options**. The default method is **Weighted**.

For more information on the available options and how the averaging is calculated, see [Averaging, page 107](#).

5. Tap **Store**.

If an averaged position for the point already exists in the database, the existing point is automatically deleted when the new average position is stored.

**NOTE** – *An averaged position is not automatically updated if the positions used to compute the average are changed. For example, if the calibration is updated, if observations are transformed or deleted, or if new observations of the same name are added, recompute the averaged position.*

### Area calculations

You can compute an area defined by points, lines or arcs. If required, you can subdivide the computed area using a parallel line or a hinge point.

**NOTE** – To compute a **surface area** you must use [Compute volume](#).

1. To compute an area:

From the map:

- a. Select the points, lines, or arcs that define the perimeter of the area to be calculated.

**TIP** – Select items in the order that they occur on the perimeter. When selecting lines or arcs, select them in the correct direction.

- b. Tap and hold in the map and then select **Area calculations**.

From the menu:

- a. Tap ☰ and select **Cogo / Area calculations**.

- b. Select the points that define the area perimeter, in the order that they occur on the perimeter.

**TIP** – You can only select points to define the area when you open the **Area calculations** screen from the menu.

- c. Tap **Calc**.

The computed area and perimeter are shown. The arrows on the lines indicate the order in which the points were selected.

2. To change how distances are calculated, tap **Options**. See [Cogo settings, page 99](#).
3. Enter a name for the area in the **Name** field.
4. To store the area without subdividing it, tap **Store**.

5. To subdivide the area:
  - a. Tap the subdivide method – **Parallel** or **Hinge**.
  - b. In the **New area** field, enter the size of the new area, which will be subtracted from the total area.
  - c. If you selected:
    - The **Parallel** method, tap the line that defines the parallel line.
    - The **Hinge** method, tap the point that defines the hinge point.

The **New area** that you entered is shaded blue. New intersection point(s) are displayed with a red circle, and labeled Pt1, Pt2, and so on.

See the example of an area subdivided using the **Hinge** method below:

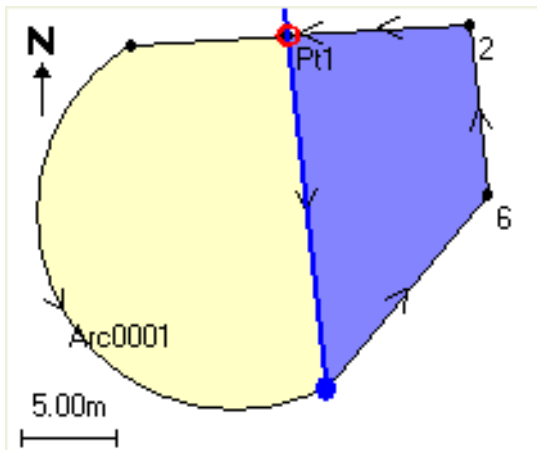

**NOTE** – If lines intersect or cross over, the software attempts to compute the correct area and subdivide the area, but in some cases may give the wrong results. Make sure that the graphical representation looks correct and then double-check the results if you have concerns that they may not be correct.

- d. If the subdivided area you require is the complement of the area displayed, tap the **Swap area** button to switch areas.
- e. Tap **Continue**.

- f. To store the intersection point(s), enter their name(s) and then tap **Save**.
- g. If you do not want to save the intersection point(s), do not name them. Tap **Close**.

To view details about the original area and perimeter, new area and perimeter, intersection points, and an image of the area, go to **Review job**.

### Arc solutions

To calculate an arc or to compute points on an arc, tap  and select **Cogo / Arc solutions**.

#### To calculate arc solutions

You can calculate an arc when two parts of the arc are known.

1. In the **Arc values** group, use the two **Method** fields to set the entry type for the arc values you have.

The first known part of the arc is defined by one of the following:

- **Radius** – is the radius of the arc.
- **Delta** – is the delta or deflection angle.
- **Degree arc** – is the deflection angle (delta) that results in an arc length of 100 units.
- **Degree chord** – is the deflection angle (delta) that results in a chord length of 100 units.

The second known part of the arc is defined by one of the following:

- **Delta** – is the delta or deflection angle.
- **Length** – is the arc length.
- **Chord** – is the chord length.
- **Tangent** – is the distance from the PC or PT to the PI.
- **External** – is the shortest distance between the Point of Intersection (PI) and the arc.
- **Mid ordinate** – is the distance between the arc and the chord at the mid point of the arc.

2. Tap **Calc**.

The results for the horizontal arc, and a graphical representation of the arc are shown. Entered data appears as black text; computed data appears as red text.

Results

The following values are computed for an arc.

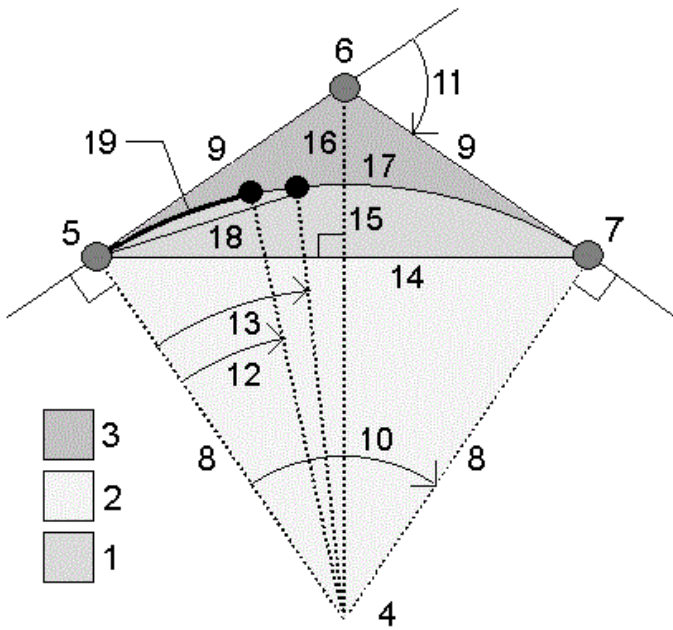

Item	Value	Definition
1	Segment area	The area between the arc and the chord.
2	Sector area	The area between the arc and the two edge radii.
3	Fillet area	The area between the arc and the tangents.
4	Center point of the arc	The center point of the arc.
5	Point of curvature (PC)	The start of the arc.
6	Point of Intersection (PI)	The point at which the tangents intersect.
7	Point of tangency (PT)	The end of the arc.
8	Radius	The radius of the arc.
9	Tangent	The distance from the PC or PT to the PI.
10	Delta angle	The delta angle.
11	Deflection angle	The deflection angle.
12	Degree arc	The deflection angle that results in an arc length of 100 units.

Item	Value	Definition
13	Degree chord	The deflection angle that results in a chord length of 100 units.
14	Chord length	The chord length.
15	Mid ordinate	The distance between the arc and the chord at the mid point of the arc.
16	External	The minimum distance between the PI and the arc.
17	Arc length	The arc length.

### To compute points on the arc

1. Tap **Layout** to compute points on the arc at any station along the arc.
2. Select one of the methods in the **Layout method** field.

#### PC deflection method

Provides the deflection angle and distance to each specified station on the arc as if you are occupying the PC point and backsighting the PI point.

Tap **Calc** to view the computed arc with these additional details:

- **Station** – is the specified station along the arc.
- **Deflection** – is the deflection angle from the tangent line (PC point to PI point) to the current station point on the arc.
- **Chord** – is the distance to the current station point on the arc from the PC point.
- **Previous station** – is the previously specified PC deflection station.

This is available only if the immediately previous point was computed using the PC deflection method.

- **Short chord** – is the chord distance from the current PC deflection point on the arc to the previous PC deflection point on the arc.

This is available only if the immediately previous point was computed using the PC deflection method.



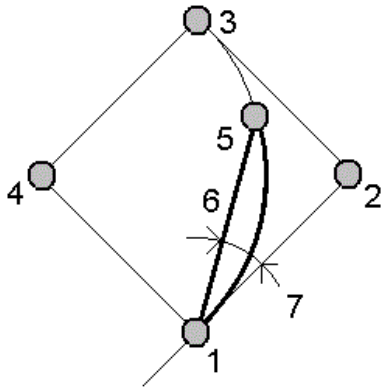

**1**

Point of curvature (PC)

**2**

Point of Intersection (PI)

**3**

Point of tangency (PT)

**4**

Center point of the arc

**5**

Current station

**6**

Chord

**7**

Deflection angle

### PI deflection method

Provides the deflection angle and distance to each specified station on the arc as if you are occupying the PI point and backsighting the PC point.

Tap **Calc** to view the computed arc with these additional details:

- **Station** - is the specified station along the arc.
- **Deflection** - the deflection angle from the incoming tangent line to the current station point on the arc.
- **PI to station** - the distance to the current station point on the arc from the PI point.

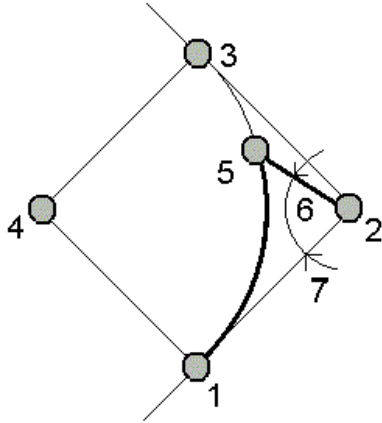

**1**

Point of curvature (PC)

**2**

Point of Intersection (PI)

**3**

Point of tangency (PT)

**4**

Center point of the arc

**5**

Current station

**6**

PI to station

**7**

Deflection angle

### Tangent offset method

Provides the perpendicular offset information from the tangent line (the line from the PC point to the PI point) to each specified station on the arc.

Tap **Calc** to view the computed arc with these additional details:

- **Station** – is the specified station along the arc.
- **Tangent dist (TD)** – is the distance along the tangent line from the PC point toward the PI point where the perpendicular offset to the arc point occurs.
- **Tangent offset** – is the perpendicular offset distance from the tangent line to the current station point on the arc.
- **Tangent** – is the length of the tangent line (the distance from the PC point to the PI point).
- **Tangent - TD** – is the remainder distance along the tangent line (the distance from the point of the perpendicular offset to the PI point).

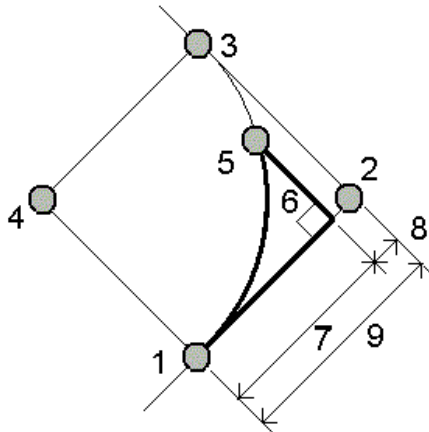

- 1  
Point of curvature (PC)
- 2  
Point of Intersection (PI)
- 3  
Point of tangency (PT)
- 4  
Center point of the arc
- 5

Current station

**6**

Tan offset

**7**

Tan distance (TD)

**8**

Tangent - TD

**9**

Tangent

### Chord offset method

Provides the perpendicular offset information from the long chord (the line from the PC point to the PT point) to each specified station on the arc. The PC deflection information is also provided.

Tap **Calc** to view the computed arc with these additional details:

- **Station** – is the specified station along the arc.
- **Chord dist** – is the distance along the long chord from the PC point (toward the PT point) where the perpendicular offset to the arc point occurs.
- **Chord offset** – is the perpendicular offset distance from the long chord to the current station point on the arc.
- **PC deflection** – is the deflection angle from the tangent line (PC point to PI point) to the current station point on the arc.
- **Chord length** – is the distance to the current station point on the arc from the PC point.

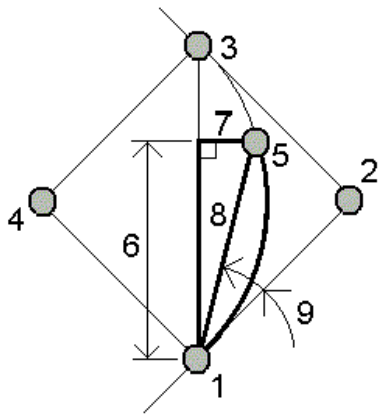

- 1  
Point of curvature (PC)
- 2  
Point of Intersection (PI)
- 3  
Point of tangency (PT)
- 4  
Center point of the arc
- 5  
Current station
- 6  
Chord distance
- 7  
Chord offset
- 8  
Chord length
- 9  
PC deflection

3. To save the results to the job, tap **Store**.  
To hide the **Layout** fields from the screen, tap **Arc**.

To add the arc and the points defining the arc to the job

1. Tap **Add**.
2. Select the start point for the arc, back tangent, and the back tangent direction.
3. Tap **Calc**.
4. Tap **Store**.

The following information is added to the job:

- calculated arc
- point defining the end point of the arc
- point defining the center point of the arc

### Triangle solutions

1. To calculate a triangle, tap  and select **Cogo / Triangle solutions**.
2. Use keyed in data and select the appropriate method to compute the triangle:

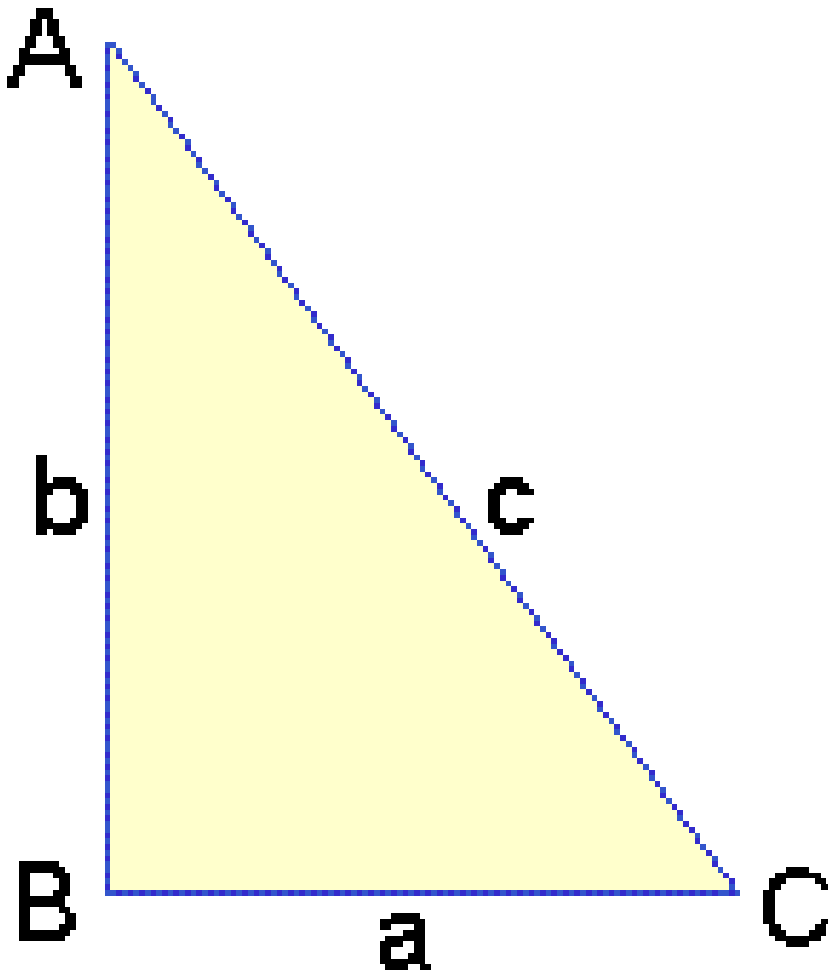

Select...	And then enter...
Side-Side-Side	The distances for sides a, b, and c.
Angle-Side-Angle	Angle A, the distance for side b, and angle C.
Side-Angle-Angle	The distance for side a, angle B, and angle A.
Side-Angle-Side	The distance for side a, angle B, and the distance for side c.
Side-Side-Angle	The distances for sides a and b, and angle A.

3. Tap **Calc.**

The lengths of sides a, b, and c, the angles of A, B, and C, the area of the triangle, and a graphical representation of the triangle are shown.

Entered data is shown as black text; computed data as red text.

4. If the **Other** softkey appears, there are two solutions to the triangle. Tap **Other** to toggle between the two possible solutions so that you can select the correct one.
5. Tap **Store**.

### Subdivide a line

1. To open the **Subdivide a line** form, you can:
  - In the map, select the line to be subdivided. Tap and hold in the map and select **Subdivide a line**.
  - Tap  $\equiv$  and select **Cogo / Subdivide a line**. Enter the name of the line.  
If the line does not already exist, tap  $\blacktriangleright$  and select **Two points**. Enter the start point and end point to define the line.
2. To set the code of the created points, tap **Options** and select the name or code of the line that is to be subdivided in the **Subdivide points code** field.
3. Subdivide the line using one of the following methods:

For the **Fixed segment length** method:

1. In the **Method** field, select **Fixed segment length**.
2. Enter the segment length **(2)**, and any horizontal offset **(3)** and vertical offset from the line.

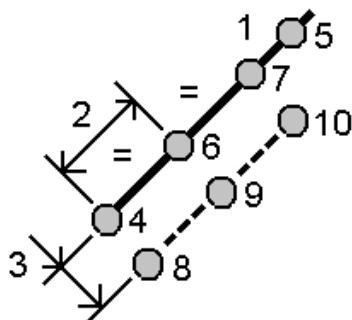

3. Enter the **Start at station(4)**, the **End at station(5)**, and the **Start point name**.



4. Tap **Start**. The software calculates the new points (**4, 6, 7, or 8, 9, 10**).

The names of the created points are incremented from the **Start point name** and are stored in the job.

For the **Fixed number of segments** method:

1. In the **Method** field, select **Fixed number of segments**.
2. Enter the number of segments, and any horizontal offset (**2**) and vertical offset from the line.

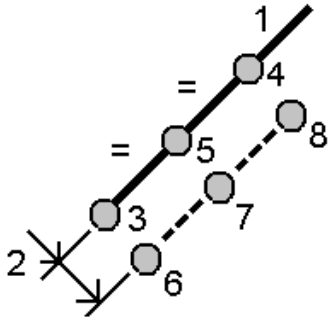

3. Enter the names of the **Start at station(3)**, the **End at station(4)**, and the **Start point name**.
4. Tap **Start**. The software calculates the new points (**3, 5, 4, or 6, 7, 8**).

The names of the created points are incremented from the **Start point name** and are stored in the job.

## Subdivide an arc

1. To open the **Subdivide an arc** form, you can:
  - In the map, select the arc to be subdivided. Tap and hold in the map and select **Subdivide an arc**.
  - Tap  $\equiv$  and select **Cogo / Subdivide an arc**. Enter the name of the arc.
2. To set the code of the created points, tap **Options** and select the name or code of the arc that is to be subdivided in the **Subdivide points code** field.
3. Subdivide the arc using one of the following methods:

For the **Fixed segment length** method:

1. In the **Method** field, select **Fixed segment length**.
2. Enter the segment length (**2**), and any horizontal offset (**3**) and vertical offset from the arc.

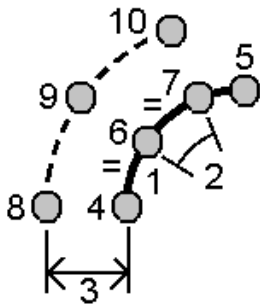

3. Enter the **Start at station (4)**, the **End at station (5)**, and the **Start point name**.
4. Tap **Start**. The software calculates the new points **(4, 6, 7, or 8, 9, 10)**.

The names of the created points are incremented from the **Start point name** and are stored in the job.

For the **Fixed number of segments** method:

1. In the **Method** field, select **Fixed number of segments**.
2. Enter the number of segments, and any horizontal offset **(2)** and vertical offset from the arc.

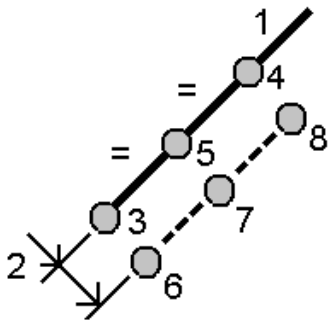

3. Enter the **Start at station (3)**, the **End at station (4)**, and the **Start point name**.
4. Tap **Start**. The software calculates the new points **(3, 5, 4, or 6, 7, 8)**.

The names of the created points are incremented from the **Start point name** and are stored in the job.

For the **Fixed chord length** method:

1. In the **Method** field, select **Fixed chord length**.
2. Enter the chord length **(2)**, and any horizontal offset **(3)** and vertical offset from the arc.

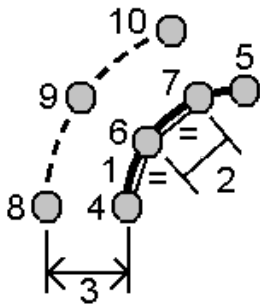

3. Enter the **Start at station (4)**, the **End at station (5)**, and the **Start point name**.
4. Tap **Start**. The software calculates the new points **(4, 6, 7, or 8, 9, 10)**.

The names of the created points are incremented from the **Start point name** and are stored in the job.

For the **Fixed angle subtended** method:

1. In the **Method** field, select **Fixed angle subtended**.
2. Enter the **Angle subtended (2)**, and any horizontal offset **(3)** and vertical offset from the arc.

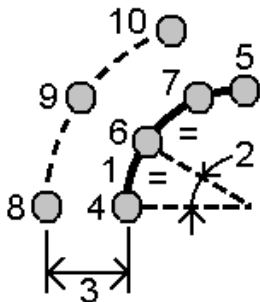

3. Enter the **Start at station (4)**, the **End at station (5)**, and the **Start point name**.
4. Tap **Start**. The software calculates the new points **(4, 6, 7, or 8, 9, 10)**.

The names of the created points are incremented from the **Start point name** and are stored in the job.

### Fix station setup

Use the **Fix station setup** Cogo Adjust function if you need to apply corrections to the station setup and all measured points using the same station setup. The **Fix station setup** function can be used to reorient and translate a station setup where temporary or incorrect azimuth or station coordinates have been used.

**NOTE** – Only station setups with a keyed in azimuth to the backsight can be reoriented or translated. A keyed in azimuth to a backsight is used when the coordinates for the station or backsight point are not known.

1. To open the **Fix station setup** form, tap  $\equiv$  and select **Cogo / Adjust / Fix station setup**.
2. From the **Station setup** field, select the point that you want to adjust. Only stations in the job that have a keyed in azimuth to the backsight can be selected.
3. Select the transformation type. Choose one or both of the following:
  - Select **Reorient station setup** to adjust the orientation of the station setup.
  - Select **Translate station** to translate the coordinates of the station to the correct coordinates.
4. Tap **Accept**.
5. If you selected the **Reorient station setup** option:
  - a. From the **Method** field, choose one of the following:
    - Select **Enter new backsight azimuth** and then enter the **New backsight azimuth** value.
    - Select **Enter rotation value** and then enter the new **Rotation** value.
  - b. Tap **Apply**.

The map updates the station and any measured points using the same station setup. The original backsight azimuth is also updated.
  - c. To save the changes to the job, tap **Confirm**. If the changes do not look correct, tap **Esc** to undo the changes.
6. If you selected the **Translate station** option:
  - a. From the **Method** field, choose one of the following:
    - Select **Two points** and then select the **From point** and the **To point**.
    - Select **Deltas** and then enter the delta **Northing**, **Easting**, and/or **Elevation**. The delta is the distance the point must be shifted.
    - Select **Key in coordinates** and then enter the new coordinates for the point.
  - b. Tap **Calc**.

An arrow on the map indicates the point that will shift and where it will move to.

c. Tap **Apply**.

The map updates the station and any measured points using the same station setup. The original occupy point is also moved.

d. To save the changes to the job, tap **Confirm**. If the changes do not look correct, tap **Esc** to undo the changes.

## Transformations

You transform point coordinates using cogo transformations or local transformations.

### Cogo transformations

Use a cogo transformation to transform a single point, or a selection of points, using one or a combination of rotation, scale or translation.

A cogo transformation deletes the original point(s) and stores new grid points of the same name.

**TIP** – To reorient and translate a station setup use the **Fix station setup** Cogo Adjust function. [Fix station setup, page 259](#) allows you to update the azimuth to your backsight, or update station coordinates, and retains all observations from the station.

### Local transformations

Use a local transformation to transform Grid (local) points to Grid points.

**NOTE** – *Local transformation support is available only when the **Advanced Geodetic** option is enabled in the **Cogo settings** screen of the job properties.*

There are often occasions in surveying where existing points to be tied into or staked out have grid coordinates defined in one or more coordinate or reference systems, which are different from the current job's coordinate system. These other coordinate or reference systems may be defined based on old base lines where the coordinates are effectively station and offset values from the base (reference) line. Or they may be referenced to a completely arbitrary reference system. For example, an architect may provide coordinates for a building foundation that needs to be positioned and transferred into a real coordinate system on site.

Unlike a cogo transformation, a local transformation does not change the coordinates of the original points. Instead, points can be created as Grid (local), and a relationship to Grid is defined that provides the transformation to the local coordinate system.

**NOTE** – *Grid (local) points cannot be displayed in the map if a transformation to grid has not been defined.*

### Applying local transformations

Origin lets you compute and store one or more local transformations that will transform on-the-fly between the grid coordinates and sets of local grid coordinates. Transformations can be applied and used when:

- Keying in points
- Linking files to the job
- Staking out points from a linked CSV or TXT file
- Reviewing the job
- In **Point manager**
- Importing a comma delimited file
- Exporting as Grid (local)

A point stored as a Grid (local) can only ever have one 'input' transformation that defines the relationship to database Grid positions. However, when viewing with **Review job** or **Point manager**, and when exporting as Grid (local), you can select a different local transformation, which changes the displayed computed Grid (local) coordinates.

You can, for example, key in a Grid (local) point referenced to one baseline or reference system, and transform to the database grid, and then, if required, use another 'display' transformation to display the point with computed Grid (local) values referenced to a different baseline or reference system. This is analogous to how any point can be displayed as station and offset to any line, arc, alignment, or road.

### TIP -

- To select a different input transformation, use **Point manager**.
- To copy transformations to other jobs, use **Copy between jobs**.

### Types of local grid transformations

In Origin you can create and apply the following types of local grid transformation:

- The **Line** transformation type is a 2D transformation that allows you to select or key in two database grid points and match them up with the local grid coordinates for the same positions.
- The **Helmert** transformation type can be a 2D Helmert transformation or a 3D transformation performed as a 2D Helmert transformation and a 1D inclined plane transformation. You can select

up to 20 identical point pairs to compute a best fit transformation between the database grid points and the local grid coordinates for the same positions.

- The **Seven parameter** transformation type is a 3D transformation that allows you to select up to 20 identical point pairs to compute a best fit transformation between the database grid points and the local grid coordinates for the same positions.

A Seven parameter transformation will provide a better solution than a Helmert transformation if the two coordinate systems are not defined with respect to the same horizontal plane.

#### To rotate, scale, or translate points

Rotate, scale, and translate transformations change the stored coordinates of a point. Only points that can be displayed as grid coordinates can be transformed.

1. Tap  and select **Cogo / Adjust / Transformations**.
2. Select **Rotate / scale / translate points**. Tap **Next**.
3. Select the transformation type. Choose one or more of the following:
  - Select **Rotate** to rotate a selection of points about a specified origin point.
  - Select **Scale** to scale the distances between the origin point and the selected points.
  - Select **Translate** to move a selection of points on a grid surface.

***NOTE** – When performing more than one transformation, the order is always rotate, scale, then translate.*

4. Tap **Next**.
5. Fill out the fields required for the selected transformation method(s):
  - **To rotate points:**
    - a. Select the **Origin point**.
    - b. Enter the **Rotation** angle or, to compute the rotation as the difference between two azimuths, tap  and select **Two azimuths**.

- **To scale points:**

- a. Select the **Origin point**.

When transforming by both rotate and scale, the origin for the scale defaults to the origin for the rotate.

- b. Enter the **Scale factor**.

- **To translate points**, from the **Method** field, choose one of the following:

- Select **Deltas** and then enter the delta **Northing**, **Easting**, and/or **Elevation**. The delta is the distance the point must be shifted.

You can select a single delta, for example a northing, or any combination of deltas for the transformation.

- Select **Two points** and then select the **From point** and the **To point**.

6. Tap **Next**.

7. Select the point(s) to transform.

Points selected in the map automatically populate the list of points to be transformed. To add points to the list, see [Selecting points, page 112](#).

**NOTE** – *If you select a base point to be transformed, then vectors flowing from this base become null.*

8. Tap **Accept**.

9. To start the transformation, tap **OK**.

10. Tap **OK**.

To create a Line transformation

**NOTE** – *Local transformation support is available only when the **Advanced Geodetic** option is enabled in the **Cogo settings** screen of the job properties.*

1. Tap  and select **Cogo / Adjust / Transformations**.

1. Select **Manage local transformations**. Tap **Next**.

2. Select **Create new transformation**. Tap **Next**.



3. Set the **Transformation type** to **Line** and then enter the **Transformation name**.
4. Select the **Start point** and then enter the corresponding Grid (local) coordinates in the **North (local)** and **East (local)** fields.
5. Select the **End point** and then enter the corresponding Grid (local) coordinates in the **North (local)** and **East (local)** fields.
6. Tap **Calc**.
7. Check the computed transformation distances and then select a **Scale factor type** to fit the local grid positions to the database grid positions. If you select:

- **Free** – The computed scale factor is applied to the Grid (local) values in both local axes.
- **Fixed to 1.0** – No scaling is applied.

The Grid (local) values are used in the transformation but have no scaling applied to them. The start point is the origin point of the transformation.

- **Along the local northing axis only** – The computed scale factor is applied to the Grid (local) northing values only during the transformation.

***NOTE** – 'Grid points' do not have to be stored as grid points, but the Origin software must be able to compute grid coordinates for the point.*

8. Tap **Store**.

The transformation appears in the map as a black dashed line between the start grid point and the end grid point.

To create a Helmert transformation

***NOTE** – Local transformation support is available only when the **Advanced Geodetic** option is enabled in the **Cogo settings** screen of the job properties.*

1. Tap  and select **Cogo / Adjust / Transformations**.
1. Select **Manage local transformations**. Tap **Next**.
2. Select **Create new transformation**. Tap **Next**.
3. Set the **Transformation type** to **Helmert** and then enter the **Transformation name**.
4. Set the **Scale factor type** to one of the following:

- **Free** – The computed best fit scale factor is used in the transformation.
  - **Fixed**– The scale factor you enter is used in the transformation.
5. Set the **Vertical adjustment** to one of the following:
    - **None** – No vertical adjustment is carried out.
    - **Constant adjustment only** – The average vertical correction computed from the elevations of the point pairs is used for vertical adjustment in the transformation.
    - **Inclined plane** – A vertical correction plus a best fit correction plane is used for vertical adjustment in the transformation.
  6. Tap **Next**.
  7. Tap **Add** to select the **Grid point name** and **Local grid point name** pairs of points and then set the **Use** field to one of the following:
    - **Off** – Do not use this point pair in the computation of the transformation parameters.
    - **Vertical only** – Use this point pair only in the computation of the vertical adjustment parameters.
    - **Horizontal only** – Use this point pair only in the computation of the horizontal adjustment parameters.
    - **Horizontal & vertical** – Use this point pair in the computation of both the horizontal and the vertical adjustment parameters.
  8. Tap **Accept** to add the pair to the list and then tap **Add** again to add more pairs of points.
  9. To view the result of the transformation, tap **Results**.
  10. Tap **Store**.

**NOTE** – *If you change the coordinates of a point used to define a Helmert transformation, you must recompute the Helmert transformation the new transformation to use the new coordinates.*

To create a Seven parameter transformation

**NOTE** – *Local transformation support is available only when the **Advanced Geodetic** option is enabled in the **Cogo settings** screen of the job properties.*

1. Tap **☰** and select **Cogo / Adjust / Transformations**.
1. Select **Manage local transformations**. Tap **Next**.
2. Select **Create new transformation**. Tap **Next**.
3. Set the **Transformation type** to **Seven parameter** and then enter the **Transformation name**.
4. Tap **Next**.
5. Tap **Add** to select the **Grid point name** and **Local grid point name** pairs of points and then set the **Use** field to one of the following:
  - **Off** – Do not use this point pair in the computation of the transformation parameters.
  - **Horizontal & vertical** – Use this point pair in the computation of both the horizontal and the vertical adjustment parameters.
6. Tap **Accept** to add the pair to the list and then tap **Add** again to add more pairs of points.  
Residuals will only start to be displayed once 3 point pairs have been defined.

**NOTE** – *The Seven parameter transformation is a three-dimensional transformation only. You cannot use 1D or 2D points in the point pairs used to compute the transformation parameters. If a Seven parameter transformation is applied to 1D or 2D Grid, or Grid (local) point, the transformed position will have null coordinates.*

7. To view the result of the transformation, tap **Results**.
8. Tap **Store**.

**NOTE** – *If you change the coordinates of a point used to define a Seven parameter transformation, you must recompute the transformation to use the new coordinates.*

### Traverse calculations

In a conventional survey, if you have surveyed a series of points using traverse stations, then you can use the **Traverse** function to calculate closed-loop traverses or open traverses that start and end on pairs of known points.

A valid traverse station has one or more backsight observations to the previous traverse station, and one or more observations to the next traverse station. To compute a traverse closure, there must be at least one distance measurement between successive points used in the traverse.

If the software calculates a misclosure then you can adjust it using either a Transit or Compass (also known as Bowditch) adjustment. The software calculates an angular adjustment and then a distance adjustment.

**NOTE** – The **Azimuth** fields do not have to be completed for points used in the traverse. If the foresight azimuth is null in a loop traverse but all angles have been observed, you can compute an angular and distance adjustment. However, if the backsight azimuth is null, the traverse cannot be oriented, adjusted coordinates cannot be stored, and an angular adjustment cannot be computed on an open traverse (you must compute a distance adjustment).

To calculate the traverse closure

1. Tap **☰** and select **Cogo / Adjust / Traverse**.
2. Enter the **Traverse name**.
3. In the **Start station** field, tap **List**.
4. From the list of valid traverse points, select the point to use as the start station. Tap **Enter**.

A valid start station has one or more backsights and one or more observations to the next traverse station.

5. Tap **Add**.

When there is only one valid traverse station, it is added automatically.

6. If there is more than one valid traverse station, select the next station in the traverse.

**TIP** –

- To view the observed azimuth and distance between two points in the list, select the first point and tap **Info**.
- To remove points from the list, select the point and tap **Remove**. All points after the selected point are also removed.

7. Continue to add points until all points in the traverse have been added.

A valid end station has one or more backsights, and one or more observations to the previous traverse station.

**NOTE –**

- *You cannot add more points after selecting a control point.*
- *You can use station setup plus type station setups within a traverse. However, the averaged orientation computed as part of the station setup is not used in the traverse computation and the resulting adjusted coordinates for the station means that the station orientation is changed.*
- *You cannot include a resection station setup (including a standard resection, Helmert resection or Refline station setup) within a traverse, but it can be used as the start or end station in a traverse.*

8. Tap **Close** to compute the traverse closure.

9. To store the closure results, tap **Store**.

To adjust the traverse

1. To select the adjustment method, tap **Options**. Select the **Transit** or **Compass** method (also known as Bowditch) then select the error distribution method for angles and elevations.
2. To adjust the angular misclosure, tap **Adj. Ang**.
3. To store the angular adjustment details, tap **Store**.
4. To adjust the distance misclosure, tap **Adj. dist**.
5. To store the distance adjustment details, tap **Store**.

When the adjusted traverse is stored, each point used in the traverse is stored as an adjusted traverse point with a search classification of adjusted. If there are any previously adjusted traverse points of the same name, they are deleted.

## Traverse options

Use these options to specify how a traverse calculation is adjusted.

Field	Option	What it does
Adjustment method	Compass	Adjusts the traverse by distributing the errors in proportion to the distance between traverse points
	Transit	Adjusts the traverse by distributing the errors in proportion to the northing and easting ordinates of the traverse points
<b>Error distribution</b>		
Angular	Proportional to distance	Distributes the angular error among the angles in the traverse based on the sum of the inverses of the distances between traverse points
	Equal proportions	Distributes the angular error evenly among the angles in the traverse
	None	Does not distribute the angular error
Elevation	Proportional to distance	Distributes the elevation error in proportion to the distance between traverse points
	Equal proportions	Distributes the elevation error evenly among the traverse points
	None	Does not distribute the elevation error

**NOTE** – The **Compass** option is the same as the *Bowditch method of adjustment*.



## Taped distances

Use the **Taped distances** function to quickly add points that define rectangular structures, such as a building or building foundations.

To start, key in or measure two points to define the first side, orientation, and location of the object. Subsequent points are created at 90° angles to or parallel to the first side. To use a different angle, store the object, and then create a new side.

Lines are created automatically and stored in the job as points are created. These lines appear in the map and can be used to stake out lines. If required, you can close the object back onto the start point to complete the rectangular shape.

**NOTE** – *To use taped distances the job must use a fully defined coordinate system, because new points created with taped distances are stored as polars. This function will not work correctly if you have selected **Scale factor only** or **No projection/no datum**.*

1. Tap  and select **Cogo / Taped distances**.
2. To define the first side:
  - a. Select or measure the **Start point** and **End point**. See [To enter a point name, page 112](#).
  - b. Enter the elevation. To select the elevation from the **Start point** or **End point**, tap  next to the **Elevation** field.
  - c. Tap **Accept**.
3. To define the next side:
  - a. To set the angle for the next point, tap beside the previous point in the direction you want the side to follow.  
  
The dashed red line shows the current direction for the next side. To change sides, in the map tap at a 90° or 180° angle to the point.
  - b. Tap **Add**.
  - c. Do one of the following:
    - In the **Length** or **H. Dist** field, enter the distance to the next point using the angle defined in the map.

If you are using a laser rangefinder, tap ► and select **Laser**. [Measure the distance with the laser.](#)

- In the **Point name** field, select a point in the job. To measure a point using the connected receiver or instrument, tap ► and select **Fastfix** or **Measure**.

The software calculates the distance to the selected or measured point.

d. Tap **OK**.

4. Continue to define the sides of the shape using the steps above.

5. When you reach the final side, do one of the following:

- To close back onto the start point, tap **Close**. A horizontal distance is computed and displayed. Use this as a check against your plan or your taped distance. Tap **Accept**.
- Enter the final length and save the end point using a different name from the start point. This may result in the final corner of the object not being at an exact right angle. After tapping **Store**, compute an inverse between the start point and the end point. This method gives more detailed information on the quality of the close.

6. Tap **Store**.

**NOTE** – *Once the feature has been stored, you cannot edit the lengths of the sides. To change a keyed in distance before the feature is stored, tap **Edit**, and then select the end point of the side to edit. When you adjust the distance, the plan view updates. You can then continue to add more sides.*

### Compute center point

You can compute the center point of a surface in an [IFC file](#). This is useful to find the center point of a bolt or cylinder so you can then stake it out.

1. You can choose whether selecting surfaces in the map selects **Individual faces** or selects the **Whole object**. To change the **Surface selection mode**, tap ☰ and select **Settings**. In the **IFC** group box, select your preferred option from the **Surface selection mode** field. See [Map settings, page 139](#).
2. In the map, tap the surface to select it.
3. Tap and hold in the map and select **Compute center point**.



The coordinates for the computed point are shown.

4. Enter the **Point name**.
5. If required, enter the code for the point in the **Code** field.
6. Tap **Store**.

### Compute intersection

To compute and store points at the intersection of features in the map:

1. In the map, select the items to intersect. You can select:
  - two points and a line
  - two lines
  - two arcs
  - two points and an arc
  - a line and an arc
2. Tap and hold in the map and select **Compute intersection**.
3. If required, enter a horizontal and/or vertical offset for each item. Tap ► to select the appropriate offset direction.

The horizontal offset direction is relative to the selected direction of the item.

4. In the **Assign elevation using** field, select how the elevation for the intersection point will be calculated.

The available options depend on the items selected but can include:

- **None** – the elevation will be null
  - **Line/Arc 1** – the elevation is computed using the grade of the first line/arc
  - **Line/Arc 2** – the elevation is computed using the grade of the second line/arc
  - **Average** – the average of the elevations is computed using the grade of the first and second line/arc
5. Tap **Calc**.

When one or both items are an arc, two intersections may be computed. You can store both points. If you don't want to store the first point, tap **Skip**.

6. Tap **Store**.

### Compute centerline

You can compute the centerline of a pipe, cylinder or ducting in an [IFC file](#). The software computes a polyline that runs along the center of the surface.

1. You can choose whether selecting surfaces in the map selects **Individual faces** or selects the **Whole object**. To change the **Surface selection mode**, tap  and select **Settings**. In the **IFC** group box, select your preferred option from the **Surface selection mode** field. See [Map settings, page 139](#).

2. In the map, tap the surface to select it.
3. Tap and hold in the map and select **Compute centerline**.

The computed centerline is shown in the map.

4. Enter the **Polyline name**.
5. If required, enter the code for the line in the **Code** field.
6. Tap **Store**.

**NOTE** – When the **Surface selection mode** is set to **Whole object**, any hidden parts of the object, such as parts that are used to join the object to another object, are also selected. This may result in a longer centerline for the surface than when the **Surface selection mode** is set to **Individual faces**.

### Calculator

To use the calculator, tap  and select **Cogo / Calculator**.

To perform a calculation from a numeric field:

1. Tap  and select **Calculator**.

If the numeric field contains a number, that number is automatically pasted into the calculator.

2. Enter the numbers and functions.
3. Tap  to calculate the result.
4. Tap **Accept**.

If you opened the calculator from a numeric field, the calculated result is pasted into that numeric field.

Tap **Azimuth** to open the **Compute azimuth** form. See [Compute azimuth](#).



Tap **Distance** to open the **Compute distance** form. See [Compute distance](#).

Tap **V. Dist** to open the **Compute vertical distance** form. Select the **From point** and the **To point**. To copy the calculated value to the calculator for use in other calculations, tap **Accept**.

Tap  to change calculator options:

- Select units (degrees, mils, gons).
- Select **Standard** or **RPN** (Reverse Polish Notation) mode.
- Select **Decimal places** to select the number of decimal places to use.

Calculator functions are described below.

Symbol	Function
+	Add
-	Subtract
×	Multiply
÷	Divide
+/-	Change sign of number being entered
=	Equals
$\pi$	Pi
	Enter
	Show all values on the stack
	Back space
<input checked="" type="checkbox"/>	Options Tap to set the angle method, calculator mode (Reverse Polish Notation (RPN) or Standard), and decimal place display.
$y^x$	Raise Y to the power of X
$x^2$	Square
$\sqrt{x}$	Square root
$10^x$	Raise 10 to the power of X

Symbol	Function
<b>E±</b>	Enter exponent or change exponent sign
$1/x$	Reciprocal
<b>x↔y</b>	Swap X with Y
<b>sin</b>	Sine
<b>sin<sup>-1</sup></b>	Arc Sin
<b>cos</b>	Cosine
<b>cos<sup>d</sup></b>	Arc Cosine
<b>tan</b>	Tangent
<b>tan<sup>-1</sup></b>	Arc Tangent
<b>log</b>	Log base 10
<b>shift</b>	Switch Shift state
(	Open parenthesis
)	Close parenthesis
<b>C</b>	Clear all
<b>CE</b>	Clear entry
<b>mem</b>	Memory functions
<b>P→R</b>	Polar to rectangular coordinate conversion
<b>R→P</b>	Rectangular to polar coordinate conversion
<b>R↓</b>	Rotate stack down
<b>R↑</b>	Rotate stack up
<b>° ' "</b>	Insert degrees, minutes, or seconds separator
<b>DMS-</b>	Subtract angles of the form DD.MMSSsss
<b>DMS+</b>	Add angles of the form DD.MMSSsss
<b>→D.dd</b>	Convert from DD°MM'SS.sss or DD.MMSSsss to angle units
<b>→DMS</b>	Convert from current angle units to DD°MM'SS.sss

## Conventional surveys

In a conventional survey, the controller is connected to a conventional instrument such as a total station or spatial station. For a list of the conventional instruments that can be connected, see [Supported equipment, page 6](#).

The steps for completing measurements using a conventional instrument are:

1. Configure the survey style.
2. Set up the instrument and position your targets at the site.
3. If it is not already connected, connect the Origin software to the instrument.
4. Start the survey.
5. Complete the station setup.
6. Measure or stake out points.
7. End the survey.

All surveys in Spectra Geospatial Origin are controlled by a survey style. Survey styles define the parameters for configuring and communicating with your equipment, and for measuring and staking points. This whole set of information is stored as a template and used each time you start a survey. The type of conventional survey you will use will depend on the available equipment and the results required. Configure the style only if the default settings do not suit your needs.

### To configure the conventional survey style

1. Tap  and select **Settings/ Survey styles**.
2. Do one of the following:
  - Tap **<Style name>** and then tap **Edit**.
  - Tap **New**. Enter a name for the style and then tap **Accept**.

3. Select each of the options in turn, and set them to suit your equipment and survey preferences.

To...	See...
configure settings for the instrument	<a href="#">Instrument configuration, page 278</a>
set parameters for topo points	<a href="#">Conventional point options, page 282</a>
configure the software to warn when duplicate points are measured	<a href="#">Duplicate point tolerance options, page 362</a>
configure stakeout settings	<a href="#">Stakeout options, page 359</a>
use a laser rangefinder	<a href="#">Laser rangefinders, page 426</a>
use an echo sounder	<a href="#">Echo sounder instruments, page 429</a>

4. Tap **Store**.

### Instrument configuration

To configure instrument settings, tap  and select **Settings / Survey styles / <Style name> / Instrument**.

The fields shown in the **Instrument** page of the survey style depend on the instrument manufacturer and model selected at the top of the screen. If you are using an instrument from a third-party manufacturer, see [To select a third-party total station, page 282](#).

#### Baud rate and parity

When you change the instrument type, the baud rate and parity settings automatically change to the default settings for the selected instrument.

Use the **Baud rate** field to configure the software baud rate to match that of the conventional instrument.

Use the **Parity** field to configure the software parity to match that of the conventional instrument.

#### HA VA status rate

Use the **HA VA status rate** field to set how often the software updates the horizontal and vertical angle display in the status line with information from the conventional instrument.

**NOTE** – Some instruments beep when communicating with the software. You can turn off the beep in the instrument or set the **HA VA status rate** to Never.

### Measurement mode

The **Measurement mode** field appears if the selected instrument type has more than one measurement mode that can be set by the Origin software. Use this mode to specify how the EDM measures distances. Options vary according to the instrument type. To change the measurement mode during the survey, tap the instrument icon in the status bar and then tap the first tile in the **Instrument functions** screen.

If you select:

- **STD**, the instrument is in EDM Standard mode, where it averages the angles while a standard distance measurement is taken.
- **FSTD**, the instrument is in EDM Fast Standard mode, where it averages the angles while a fast standard measurement is taken.
- **TRK**, the instrument is in EDM Tracking mode, where it constantly measures distances and updates them in the status line.

To always use the same setting as set on the instrument, select the **Instr. default**.

### Averaged observations

Use the **Averaged observations** method to:

- increase the measurement precision with a predefined number of observations
- view the associated measurement standard deviations

While the instrument is carrying out the measurements, standard deviations are displayed for the horizontal (HA) and vertical (VA) angles, and the slope distance (SD).

### Auto face 1 / face 2

When using a servo or robotic instrument, select the **Auto face 1 / face 2** check box to automatically measure a point or stakeout a position on face 2 after the face 1 observation.

When **Auto face 1 / face 2** is selected, once the face 1 measurement is completed, the instrument automatically turns to face 2. The point name does not increment, which allows a face 2 observation to be measured with the same point name as the face 1 observation. Once the face 2 measurement is completed, the instrument returns to face 1.

Auto face 1 / face 2 does not work when starting on face 2, or when the measurement method is set to:

- Angle offset
- H. Angle offset
- V. Angle offset
- Single dist. offset
- Dual-prism offset
- Circular object
- Remote object

#### Measure distance on face 2

The **Measure distance on face 2** option is used in:

- Measure topo, when **Auto face 1 / face 2** is selected
- Measure rounds, Station setup plus, and Resection, when a distance observation is not required on face 2

When the **Measure distance on face 2** check box is selected, if the face 1 measurement method included a distance measurement, then the measurement method for face 2 is automatically set to **Angles only** after the face 1 measurement. After the face 2 measurement, the instrument returns to the method used on face 1.

#### Autolock off for offsets

When the **Autolock off for offsets** check box is selected, Autolock technology is automatically disabled for the offset measurement and then re-enabled after the measurement.

#### Set backsight

The **Set backsight** field appears if you can set the horizontal circle reading on the instrument when the backsight is observed. The options are **No**, **Zero**, and **Azimuth**. If you select the **Azimuth** option, when you observe the backsight the horizontal circle reading is set to the computed azimuth between the instrument point and the backsight point.

#### Instrument precision

Instrument precisions are used to compute the observation weights as part of the Standard resection and Station Setup Plus computations.

Do one of the following



- Enter the values provided by the instrument manufacturer
- Leave the instrument precision value fields as null

If you leave the instrument precision value fields as null, the following default values are used:

Observation	Default value
Horizontal angle precision	1"
Vertical angle precision	1"
EDM	3 mm
EDM (ppm)	2 ppm

### Centering errors

A centering error can be specified for the instrument and backsight.

The centering error is used to compute the observation weights as part of the Standard resection and Station Setup Plus computations. Set a value appropriate to the estimated accuracy of your instrument/backsight setup.

### Servo/Robotic

The **Servo/Robotic** settings control whether the instrument automatically turns to known points, and also controls the perspective used when measuring offsets and performing stakeout. When the **Automatic** switch is set to **Yes**, the software automatically applies servo settings when connected using Bluetooth, cable or a clipped on controller, and automatically applies robotic settings when connected using Wi-Fi or Cirronet radio.

When Automatic is used	Servo setting	Robotic setting
Auto turn	HA & VA	Off
Offset & Stakeout directions	Instrument perspective	Target perspective

### Auto turn

- You can set the **Auto turn** field to **HA & VA**, **HA only**, or **Off**. If you select **HA & VA** or **HA only**, the instrument automatically turns to the point during stakeout, and when a known point is entered into a point name field.
- When the **Auto turn** field in the survey style is set to **Off**, the instrument does not turn automatically. This is desirable if you are working robotically and wish the instrument to remain

autolocked onto the target. To turn the instrument to the angle indicated on the screen, tap **Turn**.

### Offset & Stakeout directions

- **Instrument perspective:** In/out and left/right navigation directions assume you are standing behind the instrument looking toward the target.
- **Target perspective:** In/out and left/right navigation directions assume you are standing at the target looking towards the instrument.

**TIP** – Measurements are always stored and displayed relative to the instrument position. The perspective cannot be changed in **Review job**.

### To select a third-party total station

In addition to supported Spectra Geospatial instruments, you can carry out a conventional survey when connected to a total station made by one of the following manufacturers:

- Leica
- Nikon
- Pentax
- Sokkia
- Topcon
- Zeiss

When using third-party instruments, you must disable auto-connect. Some commands used by auto-connect can interfere with the communication of third-party instruments. See [Auto-connect settings, page 437](#).

To key in measurements, select **Manual** in the **Manufacturer** field of the survey style.

### Conventional point options

As part of configuring the survey style for a conventional survey, you can configure the settings for topo points measured during the survey.

To configure these settings, tap  and select **Settings / Survey styles / <style name> / Topo point**.

In the **Measure display** field, select how the observations are displayed on the controller. For a list of the available options and the corrections that are applied, see [Instrument corrections, page 290](#).

In the **Auto point step size** field, set the increment size for automatic point numbering. The default is **1**, but you can use larger step sizes and negative steps.

Select the **View before storage** check box to view observations before they are stored.

### Stakeout options

To configure stakeout options in the survey style, tap  and select **Settings / Survey styles / <Style name> / Stakeout**.

**TIP** – To change the stakeout options during stakeout, tap **Options** in the stakeout screen.

### As-staked point details

**As-staked point details** are shown in stakeout reports generated from the **Export** screen, and they are shown on the **Confirm staked deltas** screen that appears when you enable **View before storage**.

To configure **As-staked point details**, see [As-staked point details, page 511](#).

### Display

Use the **Display** group to configure the appearance of the navigation display during stakeout.

#### To configure the display for a conventional survey

Set the **Show stakeout graphics** switch to **Yes** to show the navigation graphics in the navigation screen. Setting the switch to **Yes** enables the other fields in the **Display** group.

**TIP** – If you are using a controller with a smaller screen, or you want to fit more navigation deltas on the screen, set the **Show stakeout graphics** switch to **No**. The other fields in the **Display** group are hidden when the switch is set to **No**.

The **Display mode** determines what the navigation display shows during navigation. Select from:

- **Direction and distance** – the stakeout navigation display shows a large arrow pointing in the direction you have to move. When you are close to the point, the arrow changes to the in/out and left/right directions, relative to the instrument.
- **In/out and left/right** – the stakeout navigation display shows in/out and left/right directions, with the conventional instrument as a reference point.

**TIP** – By default the software automatically gives in/out and left/right directions from the **Target perspective** in a robotic survey, and from the **Instrument perspective** when connected to a servo instrument using a face plate or cable. To change this, edit the **Servo/Robotic** settings in the **Instrument** screen of the survey style. See [Instrument configuration, page 278](#).

Use the **Distance tolerance** field to specify the allowable error in distance. If the target is within this distance from the point, the software indicates that the distance is correct.

Use the **Angle tolerance** field to specify the allowable error in angle. If the conventional instrument is turned away from the point by less than this angle, the software indicates that the angle is correct.

Use the **Grade** field to display the grade of a slope as an angle, percent, or ratio. The ratio can be displayed as **Rise:Run** or **Run:Rise**. See [Grade, page 91](#).

To configure the display for a GNSS survey

Set the **Show stakeout graphics** switch to **Yes** to show the navigation graphics in the navigation screen. Setting the switch to **Yes** enables the other fields in the **Display** group.

**TIP** – If you are using a controller with a smaller screen, or you want to fit more navigation deltas on the screen, set the **Show stakeout graphics** switch to **No**. The other fields in the **Display** group are hidden when the switch is set to **No**.

The **Display mode** determines what remains fixed in the center of the screen during navigation. Select from:

- **Target centered** – the selected point stays fixed in the center of the screen
- **Surveyor centered** – your position stays fixed in the center of the screen

The **Display orientation** determines the reference the software orientates to during navigation. Select from:

- **Direction of travel** – the software will orientate so that the top of the screen points in the direction of travel.
- **North / Sun** – the small orientation arrow shows the location of North or the sun. The software will orientate so that the top of the screen points toward North or the sun. When using the display, tap the **North/Sun** softkey to toggle the orientation between north and the sun.
- **Reference azimuth:**
  - For a point the software will orientate to the **Reference azimuth** for the job. The **Stake** option must be set to **Relative to azimuth**.
  - For a line or road the software will orientate to the azimuth of the line or road.

**NOTE** – If, when staking a point, the **Display orientation** is set to **Reference azimuth** and the **Stake** option is **not** set to **Relative to azimuth** the display orientation behavior will default to **Direction of travel**. For Stake options, see [GNSS stake methods, page 517](#).

## Deltas

Deltas are the information fields showing during navigation that indicate the direction and distance you need to travel to the entity you want to stake out. To change the deltas shown, tap **Edit**. See [Stakeout navigation deltas, page 508](#).

## DTM

To display the cut or fill relative to a DTM during stakeout, in the **DTM** group box select the DTM file. If required, in the **Offset to DTM** field, specify an offset to the DTM. Tap  and select whether the offset is to be applied vertical or perpendicular to the DTM. The **V.Dist DTM** value is to the offset position.

## Conventional

In a conventional survey, if you do not want the total station EDM set to **TRK** mode when you enter stakeout, clear the **Use TRK for stakeout** check box.

## GNSS

In a GNSS survey, to automatically start measuring when the **Measure** key is tapped, select the **Auto measure** check box.

## Compass

If your Spectra Geospatial controller includes an internal compass, you can use it when staking out a position or navigating to a point. To use the internal compass, select the **Compass** check box.

Spectra Geospatial recommends you **disable** the compass when you are near magnetic fields that may cause interference.

## Removed staked point from list

To automatically remove points from the stake out points list after they have been staked, select the **Remove staked point from list** check box at the bottom of the **Options** screen.

## Duplicate point tolerance options

The duplicate point tolerance options in the survey style determine what happens if you attempt to store a point with the same name as an existing point, or if you measure a point that is very close to an existing point that has a different name.

When configuring these settings, make sure you are familiar with the database search rules applied by the software when managing points of the same name. See [Managing points with duplicate names, page 200](#).

## Same point name options

In the **Same point name** group, enter the maximum horizontal and vertical distances or angles that a new point can be from an existing point of the same name. A duplicate point warning appears only if the new point is outside the tolerance set. To always receive a warning if you measure a point with the same name, enter zero.

## Auto average tolerance

To automatically compute and store the average position of points that have the same name, select the **Auto average** within tolerance option. An averaged position has a [higher search class](#) than a normal observation.

When the **Auto average** option is selected, and an observation to a duplicate point is within the specified duplicate point tolerance settings, the observation and the computed average position (using all the available point positions of the same name) are stored.

You can select the averaging method in the **Cogo settings** screen.

The Origin software computes an averaged coordinate by averaging the grid coordinates computed from the underlying coordinates or observations. Observations that do not allow a grid coordinate to be resolved (for example, angles only observations) are not included in the average coordinate.

If the new point is further from the original point than the tolerance specified, you can choose what to do with the new point when you store it. The options are:

- **Discard** – discard the observation without storing.
- **Rename** – rename to a different point name.
- **Overwrite** – Overwrite and delete the original point, and all other points of the same name and the same (or lower) search class.
- **Store as check** – Store with a lower classification.

- **Store and reorient** – (This option only appears if you are observing a backsight point.) Store another observation that will provide a new orientation for subsequent points measured in the current station setup. Previous observations are not changed.
- **Store another** – Store the point, which can then be averaged in the office software. The original point is used in preference to this point.

If the Store another option is used with multiple observations to a point with the same name and from the same station setup, then when measuring topo points the software automatically computes and records a Mean Turned Angle (MTA) observation to the point. This MTA observation provides the preferential position for the point.

- **Average** – Store the point and then compute and store the averaged position.

When you select **Average**, the current observation is stored and the computed average position appears, along with the computed standard deviations for the north, east, and elevation ordinates. If there are more than two positions for the point, a **Details** softkey appears. Tap **Details** to view the residuals from the average position to each individual position. You can use the **Residuals** form to include or exclude specific positions from the average computation.

#### Face 1 and face 2 observation tolerance

In a conventional survey, when you attempt to measure a point on face 2 that already exists as a face 1 measurement, the software does not warn that the point already exists.

When you carry out two-face observations in a conventional survey during **Station setup**, **Station Setup Plus**, **Resection**, or when measuring **Rounds**, the software checks that the face 1 and the face 2 observations to a point are within a preset tolerance.

If the new point is further from the original point than the tolerance specified, you can choose what to do with the new point when you store it. The options are:

- **Discard** – discard the observation without storing.
- **Rename** – rename to a different point name.
- **Overwrite** – Overwrite and delete the original point, and all other points of the same name and the same (or lower) search class.

- **Store as check** – store with a classification of Check.
- **Store another** – store the observation.

Once you have completed the **Station Setup Plus**, **Resection**, or **Round** measurements, the software saves the Mean Turned Angles to each of the observed points. The software does not check for duplicate points at this stage.

#### Different point name options

To enable proximity check for points with different names, enable the **Proximity check** switch. Enter the horizontal and vertical distance that the new point can be from any existing point.

#### **NOTE –**

- *The vertical tolerance is only applied when the new observed point is within the horizontal tolerance. Use the vertical tolerance to avoid the proximity check warning when new points are measured above or below existing points but are legitimately at a different elevation, for example the top and bottom of a vertical kerb.*
- *The proximity check is only performed on observations, not on keyed in points. The proximity check is not performed in stakeout, GNSS Continuous measurement, or Calibration Point, and it is not performed in jobs with a No Projection coordinate system.*

## To set up and connect the instrument

1. Plumb the instrument.
2. Use the tripod legs and the tribrach bubble to roughly level the instrument.
3. Start the instrument.
4. Connect the controller to the instrument. Connection options depend on the instrument you are using.

A cable connection requires no configuration. For other connection types, refer to the appropriate topic:

- [Radio connections, page 436](#)
- [Bluetooth connections, page 433](#)

5. On the controller, start Origin.



If the Origin software does not automatically connect to the instrument, see [Auto-connect settings, page 437](#).

Use the status bar to confirm the software is connected to the instrument.

## To start the conventional survey

1. In Origin, make sure the required job is open.
2. To start the survey, tap  and select **Measure** or **Stakeout**. If there is more than one survey style configured, select a survey style from the list. Select the station setup to use, for example **Station setup**.

When you select a survey style for the first time, the software prompts you to customize the style for your specific hardware.

3. When prompted, use the [electronic level](#) to level the instrument. Tap **Accept**.
4. Set the [corrections](#) associated with the instrument.

If the **Corrections** screen does not appear, tap **Options** and enter the correction information.

For some instruments, the software automatically checks to see if various corrections (PPM, prism constant, and curvature and refraction) are being applied correctly. When you select **Station setup**, messages showing what has or has not been checked are displayed in the status line. If the software finds that the corrections are being applied twice, a warning message appears.

5. Complete the station setup. See [Station setup, page 295](#).
6. Set up targets. See [Targets, page 314](#).
7. Measure or stake out points.

## Instrument corrections

You can set the corrections associated with conventional observations. By default the **Corrections** screen appears automatically after the **Electronic level** screen when you start a survey.

If the **Corrections** screen does not appear, tap **Options** and enter the correction information. To reset the default setting so that the **Corrections** screen appears automatically, tap **Options** and then select the **Show corrections on startup** check box.

**NOTE** - *If you intend to perform a network adjustment in the software using data from a conventional survey, make sure that you enter a pressure, temperature and, curvature and refraction correction.*

Use the **PPM** (Parts Per Million) field to specify a PPM correction to be applied to electronic distance measurements. Key in the PPM correction, or enter the pressure and temperature of the surrounding environment and let the software compute the correction.

Typical pressure ranges are between 500 mbar–1200 mbar, but when you work in an area with over-pressure (for example, a tunnel), larger pressures up to 3500 mbar are possible.

If you are using a that has an internal pressure sensor, the pressure field is set automatically from the sensor in the instrument. To disable this, tap the advanced pop-up arrow and then clear the **From instrument** check box.

Use the **Curvature** and **Refraction** fields to control curvature and refraction corrections. The earth curvature and refraction corrections are applied to vertical angle observations and therefore have an impact on computed vertical distance values. They also affect the horizontal distance values to a very small extent.

The earth curvature and refraction corrections can be applied independently using the options provided. The earth curvature correction is the most significant correction with a magnitude of approximately 16" per km measured distance (subtracted from the zenith vertical angle).

The magnitude of the refraction correction is affected by the refraction coefficient, which is an estimate of the change in air density along the light path from the instrument to the target. Since this change in air density is affected by factors such as temperature, ground conditions, and the height of the light path over ground, it is very difficult to determine exactly which refraction coefficient to use. If you use typical refraction coefficients such as 0.13, 0.142, or 0.2, the refraction correction results in a correction in the opposite direction to the earth curvature correction with a magnitude of approximately one-seventh of the earth curvature correction.

**NOTE -**

- The DC file format only supports a curvature and refraction correction that are both off or both on. When they are both on, they have a coefficient of 0.142 or 0.2. When settings other than these are used in the software, the settings exported to the DC file will be a best match.
- Do not set corrections in both devices. To set them in the software, make sure the instrument settings are null.

For some instruments, the software automatically checks to see if various corrections (PPM, prism constant, and curvature and refraction) are being applied correctly. If it finds that the corrections are being applied twice, a warning message appears.

In the following table, the \* symbol in a field indicates that the correction at the top of that column is applied. The \* symbol applies only to computed coordinates when a station setup has been defined. For an explanation of the correction types, see the definitions below the table.

Displayed/Sorted data	Corrections applied										
	C/R	PPM	PC	SL	Orient	Inst ht	Tar ht	Proj Cor	Stn SF	NA	POC
Status line	-	-	-	-	-	-	-	-	-	-	-
HA VA SD (raw)	-	-	-	-	-	-	-	-	-	-	-
HA VA SD	*	*	*	-	-	-	-	-	-	-	*
Az VA SD	*	*	*	-	*	-	-	-	-	-	*
Az HD VD	*	*	*	-	*	*	*	*	*	-	*
HA HD VD	*	*	*	-	-	*	*	*	*	-	*
Grid	*	*	*	*	*	*	*	*	*	*	*
delta Grid	*	*	*	*	*	*	*	*	*	*	*
Station and offset	*	*	*	*	*	*	*	*	*	*	*
DC file (observations)	-	-	-	-	-	-	-	-	-	-	*

Displayed/Shown data	Corrections applied											
	C/R	PPM	PC	SL	Orient	Inst ht	Tar ht	Proj Cor	Stn SF	NA	POC	
DC file (reduced coordinates)	*	*	*	*	*	*	*	*	*	*	*	*
JobXML (observations)	-	-	-	-	-	-	-	-	-	-	-	*
JobXML (reduced coordinates)	*	*	*	*	*	*	*	*	*	*	*	*
Survey Basic	*	*	*	*	*	*	*	*	*	*	*	*

Correction types

**C/R**

Curvature and/or Refraction correction.

**PPM**

Atmospheric parts per million (PPM) correction. PPM is calculated from temperature and pressure.

**PC**

Prism constant correction.

**SL**

Sea level (ellipsoid) correction. This correction is applied only if a fully defined coordinate system definition is being used; the correction is not applied in the **Scale factor only** definition.

**Orient**

Orientation correction.

**Inst ht**

Instrument height correction.

**Tar ht**

Target height correction.

**Proj Cor**

Projection correction. This includes the application of a scale factor specified in the **Scale factor only** definition.

### **Stn SF**

Station setup scale factor. In any station setup, a scale factor for this setup can be specified or computed. This scale factor is applied in the reduction of all observations from this station setup.

### **NA**

Neighborhood adjustment. In a station setup defined using **station setup plus** or **resection**, a neighborhood adjustment can be applied. The neighborhood adjustment is computed based on the observed residuals to the control points used during the station setup. The adjustment is applied, using the specified exponent value, in the reduction of all observations from this station setup.

### To measure points in two faces

You can observe points using face 1 (direct) and face 2 (reverse) measurements during a station setup and when using the **Measure rounds** or **Measure topo** measurement methods. The software creates Mean Turn Angle (MTA) records for observations to the same point, including paired face 1 and face 2 observations or grouped face 1 only observations.

When measuring points in two faces, consider the station setup method and the new point measurement method together and select the appropriate methods according to how you want to capture and store the data.

To use a single backsight (measured on one or both faces) and measure some topo points (on one or both faces), then use **station setup** and **Measure topo**. When measuring points on both faces, use **Measure topo** to observe the backsight on the other face. Alternatively, use **Measure rounds** and include the observation to the backsight point in the rounds. Otherwise, all foresights on face 2 will be oriented using the face 1 backsight observation.

### **NOTE -**

- *MTAs are not created during **Station setup**, but are created later if you make further observations to the backsight using **Measure topo** or **Measure rounds**.*
- *When you use **Measure topo**, MTAs are calculated and stored on the fly.*
- *Once an MTA record is written to the job database, you cannot change it. You can delete a face 1 and face 2 observation but the MTA records are not updated. You cannot delete MTA records in review.*

To measure multiple backsights, multiple rounds of observations, or to obtain better quality control of your observations, complete the station setup using **Station setup plus** or **Resection**. Either method enables you to:

- measure a single backsight point or multiple backsight points
- measure backsight and foresight points
- pair the face 1 and face 2 observations and create MTA records
- measure face 1 only observations and create MTA records
- measure one or more rounds of observations
- review the quality of the observations and remove bad observations

Use **Resection** if you also need to determine the coordinates of the instrument point by making observations to known backsight points.

After performing the station setup, use **Measure rounds** to:

- measure one or more foresight points
- pair the face 1 and face 2 observations and create MTA records
- measure face 1 only observations and create MTA records
- measure one or more sets of observations per point in one round
- measure one or more rounds of observations
- review the standard deviations of the observations and remove bad observations

If the station setup has:

- a single backsight, you can choose whether or not to include the backsight point in the rounds list.
- multiple backsights, the backsight points are not included in the rounds list.

### **NOTE -**

- *If you do not measure the backsight on face 2, then the horizontal angle face 2 measurements that were observed using **Measure rounds** will not be used when calculating the MTAs.*
- *When you use **Measure rounds** after a station setup with a single backsight, and you do not include the backsight point in the rounds list, all turned angles are calculated using the backsight observation(s) made during the station setup.*
- *When you make topo observations after a **Station setup**, and you subsequently select **Measure rounds**, you must reobserve the backsight to include it in the rounds, generate an MTA to the backsight, and calculate turned angles from the backsight MTA for all foresight points.*
- *When you use **Station setup plus** or **Resection**, all observations are stored when the station setup is complete. MTAs are stored at the end. When you use **Measure rounds**, the observations are stored at the end of each round. In all three options, the MTAs are stored at the end.*
- *You can create MTAs during a station setup using **Station setup plus** and **Resection**, and also after a station setup using **Measure rounds** or **Measure topo**. When you measure the same point (s) using **Measure rounds** or **Measure topo** after **Station setup plus** and **Resection**, the software may produce two MTAs for the one point. When more than one MTA exists for the same point in one station setup, the Origin software always uses the first MTA. To avoid having two MTAs for the same point, do not use both methods to measure a point.*

### To end the survey

If a survey is running, end it before editing the current survey style or changing to a different survey style.

1. Tap  and select **Measure / End conventional survey**.
2. Tap **Yes** to confirm.
3. Turn off the controller.

### Station setup

In a conventional survey, you must complete a **station setup** to orientate the instrument. You must have a current station setup before you can use the **Turn to** or **Joystick** functions to turn a servo or robotic instrument.

To complete a new station setup during a conventional survey, tap  $\equiv$  and select **Measure / New <station setup>**. To perform a different type of setup to the current setup you must first [end the survey](#).

Select the station setup appropriate to your requirements:

- To complete a standard station setup where the instrument is set up on a known point or if you are performing a traverse type survey, select **Station setup**.
- To measure multiple backsights, measure points using multiple rounds of observations, or to obtain better quality control of your observations, select **Station setup plus** or **Resection**. Both methods enable you to:
  - measure multiple backsight points
  - measure backsight and foresight points
  - measure one or more rounds of observations
  - review the quality of the observations and remove bad observations
- To determine the coordinates of the instrument point by making observations to known backsight points, select **Resection**.
- To determine the position of an occupied point relative to a baseline by taking measurements to two known or unknown baseline definition points, select **Refline**.

This method is often used when setting out buildings parallel to other objects or boundaries.

Once this occupation point is defined, all subsequent points are stored relative to the baseline as a station and offset.

- If you are satisfied the last completed station setup in the current job is still valid, and you wish to continue observing points from this station, select **Use last**.
- To use the last completed station setup in a different job, select **Copy last**. This option is useful when, for example, you want to store the topo data in one job and the as-built data in another job, and you don't need to re-observe the station setup in the second job.

**NOTE** - You should only select **Copy last** if you are satisfied that the last completed station setup is still valid and you wish to continue observing points from this station. When using a previous



*station setup, it is good practice to always observe a checkshot to the backsight when you start the survey.*

### To complete a standard station setup

Select **Station setup** to complete a standard station setup to one backsight, or if you are performing a traverse type survey.

1. Tap  and select **Measure** or **Stakeout / <survey style> / Station setup**.
  - a. When prompted, use the [electronic level](#) to level the instrument. Tap **Accept**.
  - b. Set the [corrections](#) associated with the instrument.

If the **Corrections** screen does not appear, tap **Options** and enter the correction information.
  - c. To configure default instrument coordinates, and default point names, heights, and azimuth settings for the instrument point and backsight point, tap **Options**. See [Station setup options, page 301](#).
  - d. Enter the instrument point name and the instrument height. See [Station coordinates and instrument height, page 299](#).
  - e. Tap **Accept**.
2. Set up the backsight:
  - a. Enter the **Backsight point name** and the **Backsight height**.
  - b. If there are no known coordinates for the point, key in an azimuth. If you do not know the azimuth, you can enter an arbitrary value and then edit the azimuth record later, in review. A null azimuth value will affect the software's ability to perform [traverse calculations](#).

**TIP** – If your survey practice does not require you to measure to the backsight, tap **Options** and clear the **Measure backsight** check box.
3. Select the measurement method in the **Method** field:
  - **Angles and distance** – measure horizontal and vertical angles and slope distance
  - **Averaged observations** – measure horizontal and vertical angles and slope distance for a predefined number of observations
  - **Angles only** – measure horizontal and vertical angles

- **H. Angle only** – measure horizontal angle only
- **Angle offset** – measure the slope distance first, the instrument can then be repointed and then measure the horizontal and vertical angles
- **H. Angle offset** – measure the vertical angle and slope distance first, the instrument can then be repointed and then measure the horizontal angle
- **V. Angle offset** – measure the horizontal angle and slope distance first, the instrument can then be repointed and then measure the vertical angle
- **Distance offset** – enter the left/right, in/out or V.Distance offset from the target to the object when a point is inaccessible and then measure horizontal and vertical angles and slope distance to the offset object

4. If you selected an offset method, tap **Options** and then:

- To set the perspective from which objects are offset, tap **Options** and change the settings in the **Servo/Robotic** group box. For more information, see [Servo/Robotic, page 281](#).
- If using Autolock technology, select the **Autolock off for offsets** check box to automatically disable Autolock technology for the offset measurement and then re-enable it after the measurement.

You can also configure these settings in the **Instrument** screen of the survey style. See [Instrument configuration, page 278](#).

5. If you have enabled the **Advanced Geodetic** check box in the **Cogo settings** screen, you can apply an additional scale factor to every conventional station setup. All measured horizontal distances are adjusted by this scale factor. To configure the scale factor settings, tap **Options**.
6. Sight the center of the backsight target and then tap **Measure**.

If the **View before storage** check box is selected in the survey style, the software shows the residuals for the station setup, which shows the difference between the known position and the observed position of the backsight point. To change the display, tap the view display button on the left of the measurement information.

7. If **Auto face 1/face 2** is enabled in the survey style or **Options** screen:
  - a. Tap **Store** to store the face 1 observation. The instrument changes face.
  - b. Sight the center of the backsight target and then tap **Measure**.
8. Tap **Store**.

### Station coordinates and instrument height

When performing a station setup at the start of a survey you are prompted to enter the coordinates of the point (station) where you have set up the instrument and the instrument height.

#### Station coordinates

If you have set up the instrument on a known point and the point is available from a linked file, select the linked file for the job and then enter the point name in the **Instrument point name** or **Backsight point name** field. The point is automatically copied to the job.

If the coordinates for the instrument point are not known but there are nearby known points, perform a [Resection](#) to the known points to obtain the coordinates for the instrument point.

If you cannot determine the coordinates for the instrument point and/or backsight point, you can key them in or measure them later using GNSS (provided that there is a valid GNSS site calibration). The coordinates of any points measured from that station are then computed.

If you enter the instrument point later, make sure that you choose to overwrite the original instrument point in the **Duplicate point** form. The coordinates of any points measured from that station are then computed.

You can use the **Point manager** to edit the coordinates of the instrument point and/or backsight point. If you do, then the positions of all records that are computed from that station setup position may change.

### Instrument height

The value you enter in the **Instrument height** field depends on the instrument you are using and whether you are measuring the **true height** of the instrument or to the **Bottom notch** on the instrument. The default method is to measure the true height of the instrument.

When measuring to the notch on a Spectra Geospatial FOCUS instrument, tap **Bottom notch**. Enter the height measured to the top ridge of the notch on the instrument. The Origin software corrects this measured slope value to true vertical and adds the offset (**Ho**) to calculate true vertical to the trunnion axis.

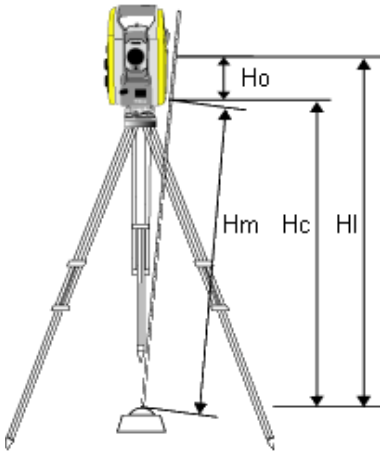

Value	Definition
<b>Ho</b>	Offset from the Bottom notch to trunnion axis. For a FOCUS instrument this value is 0.158 m (0.518 sft).
<b>Hm</b>	Measured slope distance.
<b>Hc</b>	<b>Hm</b> corrected from slope to true vertical.
<b>Hl</b>	<b>Hc + Ho</b> . True vertical instrument height.

### **NOTE –**

- If you select **Bottom notch**, the minimum slope distance (Hm) that you can enter is 0.300 meters. This is approximately the minimum slope distance that can be physically measured. If the minimum is not low enough, you must measure the true height to the top mark.
- For a 2D or planimetric survey, leave the **Instrument height** field set to null (?). No elevations are calculated. Unless you are using a **Scale only** projection, a project height must be defined in the coordinate system definition. The Origin software needs this information to reduce measured ground distances to ellipsoid distances and to compute 2D coordinates.

### Station setup options

Tap **Options** to configure **Station setup** to match the way that you prefer to work.

For other options in this screen, see [To configure the conventional survey style, page 277](#).

### Default point names

The **Default point names** option determines the default values for the instrument and the backsight point name fields each time you perform a station setup. If you:

- Always use the same names for your instrument and backsight points, select **Last used**. Use this method if you always use the default instrument coordinates, or if you repeatedly set up on the same known point.
- Are performing a traverse type survey, select **Traversing**. When you start a new station setup, by default, the instrument uses the first foresight point observed from the last station setup for the **Instrument point name**, and the instrument point name used in the last station setup for the **Backsight point name**.
- Want to key in or select the instrument and backsight point names each time you perform a station setup, select **All null**.
- Want the software to automatically increment the instrument point name, select **Auto increment**.

These are only default values. You should select the option that matches your normal workflow.

You can override the default values for any particular station setup.

**NOTE** – Do not confuse the **Last used** option with the **Use last** survey menu option. The **Last used** option applies to a new station setup. The last values are used even across different jobs. The **Use last** menu option reinstates the last station setup. No new station setup is performed.

### Default heights

The **Default heights** option determines the default values for the **Instrument height** and **Backsight point height** fields each time you perform a station setup.

- If you always use the same heights for your instrument and backsight points, select **Last used**. This option is available only if you set the **Default point names** option to **Last used**.
- If you are using a traverse kit (so that the last measured foresight and instrument heights can be used as the new instrument and backsight heights), select **Move forward**. This option is available only if you set the **Default point names** option to **Traversing**.
- If you want to key in a new instrument and backsight height for each station setup, select **All null**.

### Default instrument coordinates

If the instrument point does not exist, the default instrument coordinates are used. This is particularly useful if you work in a local coordinate system, and always set up your instrument on coordinate (0,0,0) or (1000N, 2000E, 100EI), for example.

If you leave the **Default instrument coordinates** set to null, you can key in coordinates for instrument points that do not exist when you perform a station setup.

**NOTE** – If you always set up your instrument on a known point then leave the **Default instrument coordinates** field set to null. This ensures that you do not accidentally use the default value if you incorrectly enter the name of the instrument point name.

### Default azimuth

This value is used only if an azimuth cannot be computed between the instrument and backsight points.

**NOTE** – Always set up your instrument on a known point, and use a known azimuth, then leave the **Default instrument coordinates** and **Default azimuth** fields set to null. This ensures that you do not accidentally use default values if you incorrectly enter the name of the instrument and/or the backsight point names.

### Measure backsight

The software normally expects you to measure a backsight point to orient your survey. If your survey practice does not require you to measure to the backsight, clear the **Measure backsight** check box. The software automatically creates a virtual backsight, Backsightxxxx (where xxxx is a unique suffix, for example, Backsight0001), using the current instrument orientation as the azimuth.

### Station setup scale factor

When you enable the **Advanced Geodetic** check box in the **Cogo settings** screen, you can apply an additional scale factor to every conventional station setup. All measured horizontal distances are adjusted by this scale factor. To configure the scale factor settings, select **Options** during a station setup, station setup plus, or resection.

This station setup scale factor can be Free (computed) or Fixed. If you have chosen to compute a station setup scale factor, you must observe at least one distance to a backsight during the station setup so that a scale factor can be calculated.

You can also apply a **Neighborhood adjustment** to all conventional foresight observations made from a Station setup plus or Resection, and to all GNSS observations made in a job that has a valid site calibration. See [Neighborhood adjustment](#).

### Station setup plus, resection, and rounds options

Rounds options control the order in which observations are taken, and how many observations are made when measuring rounds.

To configure these settings, tap **Options** in the **Station setup plus**, **Resection**, or **Measure rounds** screen.

### Face order

- **Face 1 only** – observations are taken only on face 1
- **Face1...face 2...** – all face 1 observations are taken to all points and then all face 2 observations are taken to all points
- **Face 1/face 2...** – face 1 and then face 2 observations are taken to the first point, face 1 and then face 2 observations are taken to the next point, and so on

### Observation order

When the **Face order** is set to **Face 1...face 2...**, set the **Observation order** to:

- **123...123** – to take observations on face 2 in the same order as the observations on face 1
- **123...321** – to take observations on face 2 in the reverse order to the observations on face 1

When the **Face order** is set to **Face 1 only** or **Face 1/face 2...**, set the **Observation order** to:

- **123...123** – to take each round of observations in the same order
- **123...321** – to take every alternate round of observations in the opposite order

### Sets per point

This option is not available during **Station setup plus** or **Resection**.

This option can be used to measure multiple sets of face 1 observations, or face 1 and face 2 observations to a point per round of observations. The maximum number of sets of observations per point per round is 10.

**NOTE** – Before using this option make sure this data collection technique matches your QA/QC requirements.

If **Face order** is set to collect face 1 and face 2 observations, the **Sets per point** was set to 3, and the **Number of rounds** was set to 1, then the total number of observations to each point would be;  $2 \times 3 \times 1 = 6$ . Setting the **Sets per point** option to a number greater than 1 enables you to collect more than one set of observations to a point with only one visit to that location.

### Number of rounds

Enter the number of times the software works through the rounds list and takes observations to each point in the list.

### Automate rounds

The **Automate rounds** option is available for Spectra Geospatial servo total stations. When you select **Automate rounds**, the instrument automatically completes all rounds after the rounds list has been built.

**NOTE** – Targets observed without Autolock are automatically paused.

When using **Automate rounds** you can configure the software to automatically skip obstructed foresight targets.

### Monitoring results between automated rounds

When **Automated rounds** is enabled, monitoring controls are also enabled. Enter a value for the time delay between automated rounds. A 3-second delay between automated rounds enables you to check the standard deviations before the next round starts automatically.

With Spectra Geospatial servo total stations, you can automatically measure to non-active targets. To do this, select the **Auto-measure passive targets** check box.



**NOTE** – If you select the **Auto-measure passive targets** check box, manually observed targets are automatically measured rather than paused. If you clear this check box, the software prompts you to aim the instrument to non-active targets.

### Skipping obstructed points

If a target has been blocked, the instrument tries to measure the point for up to 60 seconds. After 60 seconds has elapsed it skips the observation and moves to the next point in the rounds list.

If the instrument cannot measure the point and **Skip obstructed foresights** is **enabled**, it skips that point and moves onto the next point in the rounds list.

If the instrument cannot measure the point and **Skip obstructed foresights** is **disabled**, a message appears after 60 seconds to indicate that the prism is obstructed. The software continues to try to measure to the target until instructed to skip the point. To do this, tap **OK** for the obstructed prism message, tap **Pause** and then tap **Skip**.

If a point is skipped in one round, all subsequent rounds continue to prompt for observations to that point.

When one observation from a pair of face 1 and face 2 observations has been skipped, the unused observation is automatically deleted. Deleted observations are stored in the job and can be restored ("undeleted"). Restored observations can be processed in the office software, but are not automatically used to recompute Mean Turned Angle (MTA) records in the Origin software.

Backsight observations cannot be skipped using the **Skip obstructed foresights** option.

### To complete a station setup plus

Select **Station setup plus** to make observations to one or more backsight points, or to obtain better quality control of your observations.

1. Tap  and select **Measure / <Style name> / Station setup plus**.
  - a. When prompted, use the [electronic level](#) to level the instrument. Tap **Accept**.
  - b. Set the [corrections](#) associated with the instrument.

If the **Corrections** screen does not appear, tap **Options** and enter the correction information.
  - c. Enter the instrument point name and the instrument height. See [Station coordinates and instrument height, page 299](#).
  - d. Tap **Options** to configure the number of observations to make and the order in which to take them. Make sure the **Face order** setting is correct. You cannot change this setting after you

start measuring points. See [Station setup plus, resection, and rounds options, page 303](#).

e. Tap **Accept**.

2. To measure the first point:

a. Enter the first **Point name** and the **Code**, if required.

b. By default the **Backsight** check box is selected.

If the station setup point is a traverse station that you plan to adjust, **do not** measure more than one backsight point. Clear the **Backsight** check box for any additional points so that they are measured as foresights.

c. Enter the **Azimuth**.

d. Choose an option in the **Method** field.

e. Enter the **Target height**.

Make sure the target height and prism constant values are correct as you measure each point. You cannot change these values in subsequent rounds.

f. Sight the target and then tap **Measure**.

The software shows the residual information for the observation.

3. Use the information in the **Residuals** screen to review the quality of the observations and remove poor observations. See [To review observation residuals and setup results, page 310](#).

4. To observe more points, tap **+Point**.

To include foresight points during station setup plus, clear the **Backsight** check box. Foresight points do not contribute to the station setup result.

5. To take further measurements to points already measured (that is, measure rounds of observations):

a. Tap **End face**.

b. If you are using a servo or robotic instrument to measure a known (coordinated) point, tap **Turn**. Alternatively, to automatically turn a servo instrument to the point, set the **Servo auto**

turn field in the survey style to **HA & VA** or **HA only**.

**NOTE** – When using servo or robotic instruments, check that the instrument has sighted the target accurately. When measuring a DR target with a Spectra Geospatial total station with automated rounds, the software pauses to allow you to sight to the target. You **must** manually sight and measure the point to continue.

- c. When the end of the rounds list is reached, if points have been skipped the software prompts you to return to observe the points that were skipped during that round. The observations can be skipped again if required.
6. When you have completed all observations, tap **Results** to view the station setup results.
7. Tap **Store**.

#### To complete a resection

In a conventional survey, the resection function is used to perform a station setup and determine coordinates for an unknown point by making observations to known backsight points. The Origin software uses a least-squares algorithm to compute the resection.

A resection needs at least one of the following:

- Two angles and distance observations to different backsight points
- Three angles-only observations to different backsight points

**NOTE** – Because the resection calculation is a grid calculation, you can only use backsight points that can be viewed as grid coordinates. Do not compute a resection point and then change the coordinate system or perform a site calibration. If you do, the resection point will be inconsistent with the new coordinate system.

#### To complete a resection

1. Tap  and select **Measure / <Style name> / Resection**.
  - a. When prompted, use the [electronic level](#) to level the instrument. Tap **Accept**.
  - b. Set the [corrections](#) associated with the instrument.

If the **Corrections** screen does not appear, tap **Options** and enter the correction information.
  - c. Enter the instrument point name and the instrument height. See [Station coordinates and instrument height, page 299](#).

- d. To compute the station elevation, select the **Compute station elevation** check box  
For a 2D or planimetric survey, clear the **Compute station elevation** check box. No elevations are calculated. To determine the elevation of a point with known 2D coordinates, once you have completed a station setup, see [To determine the station elevation, page 313](#).
- e. Tap **Options** to configure the number of observations to make and the order in which to take them. Make sure the **Face order** setting is correct. You cannot change this setting after you start measuring points. See [Station setup plus, resection, and rounds options, page 303](#).
- f. Tap **Accept**.

2. To measure the first point:

- a. Enter the first **Point name** and the **Code**, if required.
- b. By default the **Backsight** check box is selected.

If you perform a resection or station setup plus while running an [integrated survey](#), you can measure backsight points with GNSS. To do this, tap the **Options** softkey and then select **Auto measure GNSS**. Enter an unknown point name in the point name field. The software prompts you to measure the point with GNSS using the specified point name. The **Measure** softkey shows both a prism and a GNSS symbol. The Origin software first measures the point with GNSS and then measures with the conventional instrument. Make sure that you have a site calibration loaded when combining conventional and GNSS measurements.

- c. Choose an option in the **Method** field.
- d. Enter the **Target height**.

Make sure the target height and prism constant values are correct as you measure each point. You cannot change these values in subsequent rounds.

- e. Sight the target and then tap **Measure**.

The software shows the residual information for the observation.

3. Measure further points.

To include foresight points during station setup plus, clear the **Backsight** check box. Foresight points do not contribute to the station setup result.

In a conventional survey, when two measurements are completed, or when connected to a GNSS receiver or using a controller with internal GPS, the Origin software can provide navigation information for further points. Tap **Navigate** to navigate to another point.

When there is enough data for the software to calculate a resected position, the **Resection residuals** screen appears.

4. Use the information in the **Residuals** screen to review the quality of the observations and remove poor observations. See [To review observation residuals and setup results, page 310](#).
5. To observe more points, tap **+Point**. Repeat steps 2 and 3 to add more points to the resection.
6. To take further measurements to points already measured (that is, measure rounds of observations):
  - a. Tap **End face**.
  - b. If you are using a servo or robotic instrument to measure a known (coordinated) point, tap **Turn**. Alternatively, to automatically turn a servo instrument to the point, set the **Servo auto turn** field in the survey style to **HA & VA** or **HA only**.

***NOTE** – When using servo or robotic instruments, check that the instrument has sighted the target accurately. When measuring a DR target with a Spectra Geospatial total station with automated rounds, the software pauses to allow you to sight to the target. You **must** manually sight and measure the point to continue.*
  - c. When the end of the rounds list is reached, if points have been skipped the software prompts you to return to observe the points that were skipped during that round. The observations can be skipped again if required.
7. When you have completed all observations, tap **Results** to view the resection results.
8. Tap **Store**.

**TIP** – You can use the resection function to perform an **eccentric station setup**, where the station setup is performed in view of a nearby control point and in view of at least one backsight point. For example, use this setup if you cannot set up over the control point, or you cannot see any backsight

points from the control point. An eccentric station setup needs at least one angles and distance observation to a nearby control point and one angles-only observation to a backsight point. Additional backsight points can be observed during an eccentric station setup. You can measure backsight points with angles-only observations or with angles and distance observations.

#### Helmert transformation for resection

When you enable the **Advanced Geodetic** check box in the **Cogo settings** screen, **Resection** has an additional computation method called Helmert transformation. To perform a resection using a Helmert transformation, select **Options** during a **Resection**, and then set the **Resection type** to **Helmert**.

**NOTE** – *The standard resection type is the same as the resection method used when Advanced Geodetic is not enabled.*

For a Helmert transformation, you must measure distances to the backsight points. The resection calculation will not use a backsight point without a distance measurement.

#### To review observation residuals and setup results

Use the observation residual information shown after a station setup plus or resection to review the quality of the observations and remove poor observations. A residual is the difference between the known position and the observed position of the backsight point(s).

#### **NOTE** –

- *During a station setup plus or resection, no observations are stored to the job until you store the station setup.*
- *A foresight point that does not yet exist in the database has null residuals in the **Residuals** screen.*

To view the standard deviations of the observations for each point, tap **Std Dev**. The **Std Dev** softkey is available only after all rounds are complete.

#### Station setup and resection results

To view the station setup results, tap **Results**.

To store the station setup, tap **Results** and then tap **Store**.

To view the details of an observation, select it and then tap **Details**.

To observe more points, tap **+ Point**.

To navigate to a point, tap **+ Point** and then tap **Navigate**.

**TIP** – In a conventional only survey, when one measurement is completed, the Origin software can provide navigation information for further points, and a **Navigate** softkey is available. Tap **Navigate**

to navigate to another point. If connected to a GNSS receiver or using a controller with internal GPS, the Origin software can provide navigation information for any point, and a **Navigate** softkey is available. Tap **Navigate** to navigate to another point.

### Point residuals

To view the mean observed position and the individual observations for a point in the **Point residuals** screen, tap the point.

If the residuals for an observation are high, it may be better to disable the observation from the round.

To disable an observation, highlight it and then tap **Use**. Whenever you make a change in the **Point residuals** screen, the mean observations, residuals, and standard deviations are recalculated. If you have measured face 1 and face 2 observations to a point, when you disable the observation for one face, the corresponding observation on the opposite face is automatically disabled.



**WARNING** – If you turn off some (but not all) of the observations to a backsight point in a resection, the solution for the resection is biased and there is different number of observations to each backsight point.

---

**NOTE** – If the current station setup has a single backsight only, the **Use** softkey is not available for observations to the backsight. Observations to the backsight are used to orientate observations and cannot be deleted.

If you remove observations, the  icon appears. If you skipped observations in a round, no icon appears.

### Point details

The **Point details** screen shows the mean observation to the point.

If required, you can change the target height and prism constant for all observations to that point. If you are viewing the residuals for a resection, you can change the components that are used for the resection calculation if you:

- selected the compute station elevation option
- the observed point has a 3D grid position

To do this, tap **Used for** and select:

- H (2D) to use only the horizontal values for that point in the calculation
- V (1D) to use only the vertical values for that point in the calculation

- H,V (3D) to use the horizontal and vertical values for that point in the calculation

### To create a reference line

Select **Refline** to create a baseline by taking measurements to two known or unknown baseline definition points. All subsequent points are stored relative to the baseline as a station and offset.

**NOTE** – *Because the refline calculation is a grid calculation, you can only use existing points that can be viewed as grid coordinates. You can use 2D and 3D grid coordinates to define the baseline.*

1. Tap  and select **Measure / <Style name> / Refline**.
  - a. When prompted, use the [electronic level](#) to level the instrument. Tap **Accept**.
  - b. Set the [corrections](#) associated with the instrument.

If the **Corrections** screen does not appear, tap **Options** and enter the correction information.
  - c. Enter an **Instrument point name** and **Instrument height**, if applicable.
  - d. Tap **Accept**.
2. Enter the **Point 1 name**, and **Target height**.

If point 1 does not have known coordinates, default coordinates are used. Tap **Options** to change the default coordinates.
3. Tap **Meas 1** to measure the first point.
4. Enter the **Point 2 name**, and **Target height**.

You can use a point with known coordinates for point 2 only if point 1 has known coordinates. If point 1 does not have known coordinates, default coordinates are used. Tap **Options** to change the default coordinates.
5. Enter the **Refline azimuth**.

If point 1 and point 2 have known coordinates the value shown is the computed refline azimuth, otherwise the value is 0°.
6. Tap **Meas 2** to measure the second point.

The instrument point coordinates are shown.
7. Tap **Store**.



The software creates a baseline between the two points, using the naming scheme "<Point 1 name>-<Point 2 name>". You can enter the **Start station** and **Station interval**.

**NOTE** - *If the line between the two points does already exist, the existing station is used and cannot be modified.*

### To determine the station elevation

In a conventional survey, use the station elevation function to determine the elevation of the instrument point by making observations to points with known elevations.

**NOTE** - *The station elevation calculation is a grid calculation. Use only points that can be viewed as grid coordinates. To calculate the station elevation you need at least one angles and distance observation to a known point, or two angles only observations to different points.*

1. Start a survey and perform a station set up.
2. Tap  and select **Measure / Station elevation**.

The instrument point details entered during the station setup are shown.

3. If you did not enter the instrument height during station setup, enter the instrument height now. Tap **Accept**.
4. Enter the point name, code, and target details for the point with the known elevation.
5. Tap **Measure**. Once the measurement is stored, the **Point residuals** screen appears.
6. In the **Point residuals** screen, tap:
  - **+ Point** to observe additional known points
  - **Details** to view or edit point details
  - **Use** to enable or disable a point
7. To view the station elevation result, tap **Results** in the **Point residuals** screen.
8. Tap **Store**.

Any existing elevation for the instrument point is overwritten.

## Targets

You can configure the details of the target at any point during a conventional survey.

**Target 1** and **Target DR** are already created for you. These targets can be edited but cannot be deleted.

You can create up to nine non-DR targets.

**TIP** – Configure settings for searching for, locking onto, and handling obstructed targets in the **Target controls** screen.

### To change targets

When connected to a conventional instrument the number next to the target icon in the status bar indicates the target currently in use.

To change targets, tap the target icon in the status bar or press **Ctrl + P** and then tap the target to use or press the number corresponding to the target in the **Targets** screen.

When connected to a DR instrument, **Target DR** is used to define the DR target height and prism constant. To enable DR, select **Target DR**. To disable DR and return the instrument to its last state, select target 1–9.

### To change the target height

1. Tap the target icon in the status bar.
2. Tap in the **Target height** field for the target you want to edit.
3. Edit the **Target height**.
4. To change the **Target height** measurement method, tap  and select the appropriate option for your survey setup. See [Target height](#).
5. Tap **Accept**.

If required, you can edit target height records for observations already stored in the job. See [To edit antenna and target height records, page 191](#).

### To add a target

1. Tap the target icon in the status bar.
2. In the **Targets** screen, tap **+**. The **Target properties** screen for the selected target appears.
3. Enter the **Target height**.

4. To change the **Target height** measurement method, tap **▶** and select the appropriate option for your survey setup. See [Target height](#).
5. If required, enter the **Display name** for the target. The number of the target is appended to the display name.
6. Tap **Accept**.

The software returns to the **Targets** screen, with the new target selected as the target in use.

7. Tap **Accept**.

**TIP** - To edit target properties, you must change to that target. Then open the **Targets** screen and tap **Edit**.

### Target height

The value you enter in the **Target height** field depends whether you are measuring the true height of the prism or to the notch on a traverse prism base. The default method is to measure the true height of the prism.

When measuring the target height to the notch on a traverse prism base, tap **▶** in the **Targets** screen and select **S notch**. The **S notch** corresponds to the **Bottom notch** on a Spectra Geospatial FOCUS instrument.

The Origin software corrects the measured slope value to true vertical and adds the appropriate offset value to calculate the true vertical height to the center of the prism.

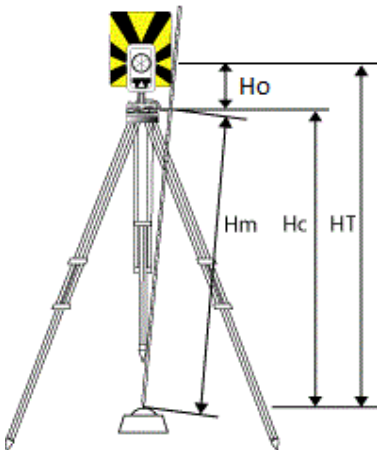

Value	Definition
<b>Ho</b>	Offset from the notch to center of the prism. For the <b>S notch</b> this value is 0.158 m (0.518 sft).
<b>Hm</b>	Measured slope distance.
<b>Hc</b>	<b>Hm</b> corrected from slope to true vertical.
<b>HT</b>	True vertical target height. <b>Hc + Ho</b> .

**NOTE** – If you select **S notch**, the minimum slope distance (*Hm*) that you can enter is 0.300 meters. This is approximately the minimum slope distance that can be physically measured. If the minimum is not low enough, you must measure the true height to the center of the prism.

### Prism constant

When you select a Spectra Geospatial prism in the **Prism type** field of the **Target properties** screen, the prism constant is automatically defined. If you select **Custom** in the **Prism type** field, you must manually enter the prism constant.

Selecting the correct prism type and entering the correct prism constant ensures that the appropriate correction values are applied to the slope distance and vertical angle for geocentric offset and prism constant. The correction is only significant when observing steep vertical angles.

Enter the **Prism constant** in millimeters (mm). Enter a negative value if the prism constant is to be subtracted from measured distances.

When using a Spectra Geospatial total station, all corrections are applied in the Origin software.

For some third-party instruments, the Origin software checks to see if a prism constant has been applied by the instrument **and** the software. When you select **Station setup**, status line messages show what has or has not been checked.

If the software cannot check the setting on the conventional instrument, but:

- If there is a prism constant set on the instrument, make sure that the prism constant in the software is set to 0.000.
- If there is a prism constant set in the software, make sure that the prism constant in the instrument is set to 0.000.

If required, you can edit prism constant records for observations already stored in the job using **Review job** or **Point manager**.

### Target control settings

Configure settings for locking onto targets in the **Target controls** screen.

To access the **Target controls** screen, tap the Instrument icon in the status bar and then tap and hold on the **Autolock** or **Search** button.

The fields shown in the **Target controls** screen depend on the selected **Target lock** method and the connected instrument.

### Target lock

Select the method for locking onto the target. See [Enabling Autolock, page 318](#).

### Predictive tracking time

Use the **Predictive tracking time** setting to pass behind a temporary obstruction and have the instrument continue to turn, based upon the target's horizontal trajectory, when lock to the prism is lost.

### Instrument behavior

If the trajectory is consistent and the prism re-appears from behind the obstruction within the defined **Predictive tracking time** interval, the instrument will be aimed directly at the prism and lock is automatically regained.

If the prism does not reappear after the specified time interval, the software reports that the target is lost.

### Recommended interval

- For standard robotic usage, Spectra Geospatial recommends the default setting (1 s).  
This enables you to pass behind anything small blocking the line of sight between the instrument and the target (for example, trees, electrical posts, or vehicles) and then automatically regain lock.
- In environments with a number of reflective objects, you could set the predictive tracking time to 0s.

With these settings, you are immediately informed if the line of sight to the correct target is obstructed. You can then ensure that you regain lock to the correct target.

- In environments where your target may be blocked for a few seconds at a time, you can use settings of 2 s or 3 s.

This enables you to pass behind larger objects blocking the line of sight between the instrument and the target (for example, small buildings) and then automatically regain lock.

If the instrument fails to regain lock onto the moving target, it returns to the location where it first lost lock and the predictive tracking began.

### Search window

The search window settings control the size and center of the window the software uses when searching for targets.

Configure the tolerance window **Horizontal range** and **Vertical range**.

### GPS search

To use a GPS/GNSS receiver to help point the instrument when searching for targets, see [GPS Search, page 318](#).

### Enabling Autolock

Spectra Geospatial instruments provide Autolock technology for locking onto and tracking remote moving targets.

### To enable Autolock

1. Configure the **Target lock** method and related settings in the **Target controls** screen.
2. Tap the Instrument icon in the status bar to open the **Instrument functions** screen.
3. Tap the button for the configured target lock method to enable it. The **Autolock** button is yellow when enabled.

A search is automatically performed if a measurement is initiated when Autolock is enabled but the instrument is not locked to the target.

When **GPS search** is ready, a GPS-aided search is performed instead of a standard search. To perform a standard search, pause GPS Search, or tap **Search** in the **Joystick** screen.

### GPS Search

During a **robotic survey**, if the instrument loses lock to the target and the software is connected to a GNSS receiver, you can use the GPS/GNSS receiver to help point the instrument to the target.

By default, GPS Search is enabled when Origin is:

- connected to a Spectra Geospatial GNSS receiver and running an integrated survey
- running on a controller with internal GPS

**NOTE** – When using a controller with internal GPS, a connected GNSS receiver is always used in preference to the internal GPS.

**TIP** – To connect the controller to a third-party auxiliary GNSS receiver, see [Auxiliary GPS settings, page 341](#).

If the total station is set up in terms of the defined projection and datum, then GPS Search is ready as soon as the station setup is complete. When GPS Search is ready, the message **GPS Search ready** appears in the status line, and the target icon displays a satellite icon above the prism .

If you do not have a fully define coordinate system, or if you are using a custom auxiliary GNSS receiver, you will need to configure GPS Search before you can use it. You can use GPS Search when connected to an auxiliary GNSS receiver that is outputting NMEA GGA messages at 1 Hz through a serial or Bluetooth port to the controller.

#### To configure GPS search settings

1. Start a robotic survey.
2. Tap  and select **Instrument / Target controls**.
3. In the **GPS Search** group, set the **On** switch to **Yes**.
4. Set the **Enable 3D** check box as required.
  - If **3D** is enabled, a 3D GPS Search position is computed, and the instrument can turn to the point both horizontally and vertically.

If the connected GNSS receiver is initialized in an RTK survey, or if SBAS is available, you can enable **3D** because the GNSS heights from the receiver should be accurate enough to turn the instrument's vertical angle.

- If **3D** is disabled, the instrument can only turn horizontally to the GPS Search position.

If the connected GNSS receiver is producing autonomous positions, or if SBAS is not available, Spectra Geospatial recommends that you disable **3D** to prevent incorrect GNSS heights causing inaccurate turning of the vertical angle.

**TIP** – In an integrated survey, the **Select data source** is automatically set to **Spectra Geospatial GNSS** and the **3D** check box is selected by default.

5. Make sure the value in the **Select data source** is correct. If the software is connected to:
  - A Spectra Geospatial GNSS receiver, select **Spectra Geospatial GNSS**.
  - The controller's internal GPS receiver, select **Internal GPS**.
  - Another type of GNSS receiver, select **Auxiliary GPS**.

6. Make sure the value in the **Receiver type** field is correct. If it is not, tap the **Aux** softkey and then configure the **Auxiliary GPS** settings for the internal or custom receiver. See [Auxiliary GPS settings, page 341](#).
7. Tap **Accept**.

GPS search is now configured. The [relationship between the GNSS positions and local positions](#) must be resolved before you can use GPS search.

#### Resolving the relationship between GNSS positions and local positions

If you have a **fully defined coordinate system**, then an accurate relationship between the GNSS positions and local positions already exists using the coordinate system definition. The software assumes that the total station is set up in terms of the defined projection and datum, and GPS Search is ready as soon as the station setup is complete. If your total station is not set up in terms of the defined coordinate system then using GPS Search will cause the total station to turn incorrectly.

If you do **not** have a defined coordinate system, you must resolve the relationship between GNSS positions and local positions before GPS Search is ready. Once a station setup is complete, the Origin software uses the NMEA positions from the GNSS receiver and the angles tracked by the robotic instrument to determine the relationship between the two positioning systems. GPS Search computes the relationship independently of the job's coordinate system settings.

To determine the relationship, make sure that the GNSS receiver has a clear view of the sky and then, with the instrument locked to the prism, move the pole around the instrument until the relationship between the GNSS positions and local positions is resolved. A minimum of five positions at least five meters apart and at least ten meters from the instrument are required. If the geometry and GNSS positional accuracy is poor, you need more than five positions to resolve the relationship. Poor GNSS positional accuracy may result in an inaccurate relationship being computed.



**NOTE -**

- To view the GNSS status, tap **GPS** on the **Target controls** screen. Alternatively, from the GNSS status screen, tap and hold on the target icon.

**TIP -** If you are going into a bad GNSS environment for an extended period of time, tap pause



to pause GPS Search and stop new positions being added into the GPS Search solution. Tap





to resume GPS Search and start adding points into the GPS Search solution again.

- When GPS search has good data, it can detect bad data and exclude it from its computations. However, if there are more bad positions than good positions, it is difficult for GPS Search to detect and exclude bad positions. Too much bad data in the computations may prevent GPS Search from becoming ready. If this occurs, move to a better GNSS environment and then tap **Reset** to restart the GPS Search.
- If you perform a calibration or change the coordinate system settings, the existing relationship between the GNSS positions and local positions is lost and must be recomputed.

Using GPS Search

The software automatically uses GPS Search when searching for the target. If GPS Search is ready, the instrument turns to the GPS Search position. With a good GNSS position, for example from a Spectra Geospatial SP85 receiver with an RTK fixed solution, and when snap is enabled, the instrument should snap to the target immediately. If the instrument does not snap immediately, it performs a search before locking to the target.

When using GPS Search with a Spectra Geospatial receiver, a cross indicates the position of the GNSS receiver. When using any other receiver and a GNSS position is available, a satellite icon appears in the map. If a GPS Search solution is available, a black satellite icon appears . If a GPS search solution is not available, a red satellite icon appears . To turn to the GNSS position in a conventional survey, make sure that there is nothing selected in the map and then tap and hold briefly in the map. From the menu that appears, select **Turn to GNSS** to turn the instrument horizontally to the GNSS position.

Tap **Search** in the **Joystick** screen to perform a normal search even when GPS Search is ready. Use this when you need to search for a target without using the GPS Search position, such as searching for a backsight target.

To perform a GPS-aided search from the **Joystick** screen, tap **Search**.

**NOTE -** As soon as the instrument locks on to the target, the **Joystick** screen closes.

To perform a standard search throughout the Origin software, pause GPS Search at any time.

## Instrument functions and settings

The **Instrument** menu provides information about the conventional instrument connected to the controller, and is used to configure the settings for the instrument. Available options depend on the type of instrument that is connected.

**NOTE** – If a GNSS receiver is also connected and you are performing an integrated survey, additional items appear in the **Instrument** menu. For more information, see [Receiver functions and settings, page 400](#).

### Instrument functions

To access the **Instrument functions** screen, tap the instrument icon in the status bar.

The functions available depend on the instrument that the controller is connected to. A yellow button indicates the function is enabled.

**TIP** – When in the **Instrument functions** screen, you can use the controller keypad to enter the keypad character (**1-9, 0, -** or **.**) indicated on the tile to enable/disable the function or open the appropriate screen. If you have configured a function key on the controller as a shortcut to an instrument function, you can press the configured function key when viewing any screen in the software.

### EDM and laser pointer controls

To switch EDM measurement mode, tap the first button in the **Instrument functions** screen to cycle through the available modes.

- For most Spectra Geospatial instruments, when you select:
  - **STD**, the instrument is in **EDM Standard mode**, where it averages the angles while a standard distance measurement is taken.
  - **TRK**, the instrument is in **EDM Tracking mode**, where it constantly measures distances and updates them in the status line.

To enable or disable the laser pointer, tap **Laser**. To configure EDM settings, tap and hold the **Laser** button.

To enable or disable DR mode, tap **DR**. To configure EDM settings, tap and hold the **DR** button.

For more information, see [EDM settings, page 324](#).

### Instrument controls

- To view the **Joystick** screen, tap **Joystick**. See [Joystick, page 327](#).
- To view the **Turn to** screen, tap **Turn to**. See [Turn to, page 328](#).
- To change the instrument face, tap **Change Face**. See [To measure points in two faces, page 293](#).

### Target controls

- To enable the tracklight, tap **Tracklight**. To configure Tracklight settings, tap and hold the **Tracklight** button. See [Tracklight, page 326](#).
- To turn on target lock, tap **Autolock**. See [Target control settings, page 316](#).
- To search for the target, tap **Search**. To configure the search window, tap and hold the button. See [Target control settings, page 316](#).

### Instrument setup

- To view the **Electronic level** screen, tap **Level**. See [Electronic level, page 323](#).
- To view the **Survey Basic** screen, tap **Survey Basic**. See [Survey Basic, page 329](#).

### Electronic level

The **Electronic level** screen appears automatically when you start a conventional survey. To view the screen at any time:

- Tap the instrument icon in the status bar and then tap and hold the **Level** button.
- Tap  and select **Instrument / Electronic level**.

### To level the instrument

1. If the instrument is not level enough in the **Electronic level** screen appears, you may get a tilt error. To bring the electronic level into range, use the tripod legs to level the instrument, using the tribrach circular bubble as a guide.
2. When the instrument appears level in the tribrach circular bubble, use the footscrews to level the instrument using the **Electronic level** screen as a guide.



**WARNING** – If accuracy is important, do not disable the compensator. If you do disable the compensator, horizontal and vertical angles in the instrument are not corrected for mis-levelment errors.

---

3. Tap **Accept**.
4. To perform a compensator calibration after leveling the instrument, tap **Calib**. See [Compensator calibration, page 324](#).

### Compensator calibration

Spectra Geospatial recommends that you calibrate the compensator periodically, especially before you take precise measurements.

**NOTE** – If *Origin* is running on a *FOCUS 50*, detach the *FOCUS 50* from the instrument before calibrating the compensator.

1. Level the instrument using the **Electronic level** screen.
2. Tap **Calib**.
3. Tap **Next**.

The instrument slowly rotates through 360°.

When the calibration is complete, a success message appears.

4. Tap **OK**.

If the calibration is unsuccessful, the message **Calibration failed** appears. Tap **Esc**. Check the instrument setup, and re-level the instrument. Repeat the calibration. If it still fails, contact your Spectra Geospatial service provider.

### EDM settings

Use the **EDM settings** screen to configure settings for the electronic distance meter in the instrument. The available settings depend on the type of instrument that the controller is connected to.

To view the **EDM settings** screen:

- Tap  and select **Instrument / EDM settings**.
- Tap the instrument icon in the status bar to view the **Instrument functions** screen and then tap and hold the **Laser** or **DR** button.

## Direct Reflex

Select the **Direct Reflex** check box to enable DR mode.

When the EDM is in DR mode, it can measure to non-reflective instruments. When you turn on DR, the software automatically switches to **Target DR**. When you turn off DR, the software returns to the last used non-DR target.

You can also enable DR mode by tapping **DR** in the **Instrument functions** screen, or by changing the target to **Target DR**.

## Laser pointer

Select the **Laser pointer** check box to enable the laser pointer. You can also enable or disable the laser by tapping **Laser** in the **Instrument functions** screen.

**TIP** – To streamline the process of locating a prism in dark environments, enable the **LaserLock** check box in the **Target controls** screen and enable the laser pointer in the **EDM settings** screen. If the **LaserLock** check box in the **Target controls** screen is not enabled then you must select the **Direct Reflex** check box to enable DR mode and make the **Laser pointer** check box available in the **EDM settings** screen.

## Blink laser

To blink the laser and the tracklight or the target illumination light (TIL) when storing a point measured with DR mode, select the number of times the laser will blink in the **Blink laser** field.

The **Blink laser** field is not available when the **Laser power** field is set to **Extended range flashing** (SX12 only).

## Prism standard deviation / DR standard deviation

To define the acceptable accuracy of a measurement, enter a **Prism standard deviation** or **DR standard deviation** value, depending on the mode the instrument is in. When measuring to diffuse targets the standard deviation is displayed on the status line until the standard deviation satisfies the defined value. Once the standard deviation is satisfied, the measurement is accepted. To accept the measurement before the standard deviation is satisfied, tap **Enter** while the standard deviation is displayed on the status line.

## DR minimum and maximum distance

Enter a suitable DR minimum and maximum distance for your survey. Increasing the maximum distance will increase the time that it takes for a measurement to complete, even if the distance being measured is less than the specified maximum. The default maximum distance provides a balance between measurement time and range. Increase the maximum distance if you are working at longer ranges. To restrict the DR measurement range, enter a minimum and maximum distance to avoid a result from a distant or intermittent object.

### Long range

Use the long range mode when a strong instrument signal is required for measuring to targets more than one kilometer (about 0.6 miles) away.

### Weak signal

To accept measurements at a lower accuracy (that is, below the normal instrument specification), enable **Weak signal**.

### 10 Hz tracking

Use 10 Hz tracking when a faster update rate is required when using **Tracking mode**.

### **NOTE -**

- *This option is only available if you are in both Autolock and Tracking mode. If you select DR or turn Autolock off when tracking, the software will default to normal tracking mode.*
- *Although tracking is faster the precisions will be null for the stored point.*

### Tracklight

The tracklight is a visible light that guides the prism operator on the correct bearing.

**NOTE -** *When storing a point measured with DR mode, the tracklight and the laser blink for the number of times set in the **Blink laser** field of the **EDM settings** screen. See [EDM settings, page 324](#).*

To turn on or turn off the tracklight:

1. Tap the Instrument icon in the status bar to open the **Instrument functions** screen.
2. Tap **Tracklight**.

To set the speed of the tracklight:

1. Tap and hold the **Tracklight** button in the **Instrument functions** screen.
2. Select the **Enable tracklight** check box.
3. In the **Speed** field, select the required speed.

When **Auto** is selected, the Tracklight flashes fast when the target is locked and slow if there is no target.



## Joystick

If you are operating a robotic instrument at the remote end (target), use the **Joystick** softkey to turn the instrument towards the target when lock has been lost.

1. Tap the Instrument icon in the status bar to open the **Instrument functions** screen.
2. Tap **Joystick**.
3. Tap an arrow on the screen or press the up, down, left, or right arrow keys to turn the instrument.

Tapping a diagonal arrow moves the instrument horizontally and vertically. How far the instrument turns depends on how long the arrow is held down.

**TIP** – To increase or decrease the turning speed, tap the left (decrease) or right (increase) speed arrows.

4. To fine-tune the position of the instrument, tap the inner arrows. The inner arrows always turn at half of the minimum speed setting.
5. To change the direction tap the change direction button ( , ).
  - When the instrument icon is to the left of the prism icon, the instrument turns as if you are standing behind the instrument.
  - When the instrument icon is to the right of the prism icon, the instrument turns as if you are standing at the pole facing the instrument.
6. To make the instrument locate and lock on to the target, tap **Search**. The instrument starts searching for the target.

When [GPS Search](#) is ready, the **Search** softkey is available. To perform a GPS-aided search, tap **Search**.

The search results are shown in the status line:

- Target Locked – indicates that the target has been located and tracking locked.
- No Target – indicates that the target was not located.

## Turn to

If using a servo or robotic instrument, you can use the **Turn to** options to control how the instrument moves.

1. Tap the Instrument icon in the status bar to open the **Instrument functions** screen.
2. Tap **Turn to**.
3. To turn the instrument:
  - horizontally  $90^\circ$  to the right or left, or  $180^\circ$  tap the appropriate softkey at the bottom of the screen.
  - to a horizontal or vertical angle, select **HA** or **VA** in the **Method** field and then enter the angle in the **Turn to** field.
  - to a horizontal and vertical angle, select **HA & VA** in the **Method** field and then enter the horizontal angle in the **Turn to HA** field, and the vertical angle in the **Turn to VA** field.
  - to a specified point, select **Point name** in the **Method** field and then enter or select the point in the **Point name** field, or select the point in the map. If more than one point is selected then the instrument will turn to the last selected point.
  - by distance, select **Distance** in the **Method** field and then enter the distance from your current position to the point where the instrument lost lock. This aids the **Search** option to locate the target when you have lost lock.
4. To make the instrument locate and lock on to the target, tap **Search**. The message "Searching..." appears and the instrument starts searching for the target.
5. Tap **Turn**. The instrument turns to the angle(s) or point you entered.

## To navigate to a point

If the controller is connected to a GNSS receiver, or you are using a controller with internal GPS, you can navigate to a point

- during a conventional survey if you lose lock to the target
- before you start a survey.

**NOTE** – *When using a controller with internal GPS, a connected GNSS receiver is always used in preference to the internal GPS.*



The **Navigate to point** function uses the settings in the last used GNSS survey style.

**NOTE** – *If you are using a GNSS receiver that can track SBAS signals, when the radio link is down you can use SBAS positions instead of autonomous positions. To use SBAS positions, set the **Satellite differential field** in the survey style to SBAS.*

1. To navigate to a point, you can
  - Select the point in the map. Tap and hold in the map and select **Navigate to point**.
  - Tap ☰ and select **Instrument** or **Receiver / Navigate to point**.
2. Fill out the other fields as required.
3. To change the display mode, tap **Options**. The display options are the same as the display options in the **Stakeout options** screen. See [Stakeout navigation display, page 504](#).
4. Tap **Start**.
5. Use the arrow to navigate to the point, which is shown as a cross. When you are close to the point, the arrow disappears and a bull's-eye symbol appears. A grid also appears and changes scale as you move closer to the target.

When you are on the point, the bull's-eye symbol covers the cross.

6. If required, mark the point.
7. To store the point, tap **Position** and then tap **Store**.

## Survey Basic

Survey Basic is available when you connect a controller to a Spectra Geospatial instrument.

You can use it as follows:

- If a job was created with a station setup, then Survey Basic can display raw data, and coordinates based on the station setup in the job.
- If a current station setup does not exist, you can:
  - Make simple distance or angular checks.
  - Define the northing and easting coordinates for the instrument point in Survey Basic, set the horizontal circle and then display coordinates for points observed using Survey Basic.

- Key in the elevation for the instrument point and then display the elevation for points observed using Survey Basic.
- Observe to a point with a known reference elevation to compute the instrument elevation and then display the elevation for points observed using Survey Basic.

**NOTE** – *You cannot store measurements in Survey Basic.*

### Survey Basic functions

To view the **Survey Basic** screen, tap the instrument icon in the status bar and then tap **Survey Basic**.

Tap the ...	to ...
Instrument icon on the status bar	access the <b>Instrument functions</b> screen
Target icon	set or modify the target height
<b>Zero</b> softkey	set the instrument horizontal circle to 0
<b>Set</b> softkey	set the horizontal circle
	set the target height
	set the reference elevation, and compute the instrument elevation
	set the instrument point coordinates, and instrument elevation
<b>Options</b> softkey	set the instrument height
	modify the correction values used in Survey Basic
<b>Clear</b> softkey	reset the angles back to live and clear the slope distance after a measurement
Display view button	switch the display between HA, VA, SD and HA, HD, VD
Press the ...	to ...
Enter key	measure a distance and fix the horizontal and vertical angles

**NOTE** – When a survey is running you cannot change:

- the instrument's horizontal circle
- the instrument point coordinates
- correction values

To compute the instrument point elevation from a known reference point

1. Ensure that a current station setup does not exist and then start Survey Basic.
2. Tap **Set** and then enter the **Target height**, **Reference elevation**, and **Instrument height**.
3. If required, enter the **Horizontal angle** and instrument point **Northing** and **Easting**.
4. To measure the reference point, tap **Measure**. The instrument point **Elevation** is computed.
5. To return to Survey Basic, tap **Accept**.

To change the view on the data displayed, tap the arrow button.

**NOTE** –

- If the target height **or** instrument height is null, the software cannot calculate a VD.
- If target height and instrument height are **both** null, the software assumes zero for both and can compute the VD, but cannot compute the elevation.
- If a station setup is computed using Survey Basic, a scale only projection of 1.0 is used to calculate coordinates.

To compute the inverse distance between two measurements

Inverse provides the ability to display inverse calculations between two measurements. You can configure inverse to compute Radial inverses from a single measurement to one or more other measurements, or Sequential inverses between successive measurements.

1. From the Survey Basic front screen tap **Inverse**. (In portrait mode, swipe right to left along the row of softkeys to view the more softkeys.)
2. Set the **Method** to Radial or Sequential.
3. Enter a target height, if required.
4. Tap **Meas 1** to measure to the first point.



5. Enter a target height, if required.
6. Tap **Meas 2** to measure to the next point.
7. The inverse results are displayed.
  - Tap **Continue** to measure subsequent points. The process then continues from step 4.
  - Tap **Reset** to return to step 1.
8. To return to Survey Basic, tap **Esc**.

**NOTE -**

- *If there is a survey running, the azimuth for each computed inverse will be displayed, and you will be able to select whether to display Grid, Ground or Ellipsoidal distances using the **Options** softkey, with the computations based on the settings in the current job.*
- *Without a survey running, and therefore no orientation, the azimuth is not available for computed inverses and all computations are based on simple cartesian computations with a scale factor of 1.0.*
- *To configure the format of the grade display, tap **Options**.*

**AT360 eBubble options**

If the active target has built-in tilt sensors and you are performing a conventional survey, an eBubble (electronic bubble) showing tilt information for the target is available. To configure the eBubble, you can:

- Tap  in the **eBubble** window.
- Tap  and select **Instrument / eBubble options**.

You can configure the following settings:

Option	Description
eBubble sensitivity	The bubble moves 2 mm for the specified sensitivity angle. To decrease sensitivity select a large angle.
Tilt tolerance	Defines the maximum radius that the target can tilt and be considered in tolerance. The allowable range is 0.001 m to 1.000 m. The tilt distance shown is calculated using the current target height.

**TIP** – If you have more than one tilt sensor connected, you can also tap the **AT360** softkey from the **eBubble options** screen for a different sensor. Changing the eBubble settings for one sensor changes the eBubble settings for all connected tilt sensors.

### eBubble calibration

To calibrate the eBubble tap the **Calib** softkey and then tap the **Calibrate** button to begin tilt calibration. Level the instrument with the calibrated reference and brace against movement. Tap **Start**. The calibration information is stored in the job.

A well-calibrated eBubble is of vital importance. The accuracy of tilt information used to display the eBubble, and stored with measured points, is totally dependent on the calibration of the tilt sensors inside the active target. Using a poorly-calibrated eBubble will directly degrade the accuracy of the coordinates measured using the eBubble as a level reference. Great care should be taken when you are calibrating the eBubble to ensure the most accurate tilt information is available at all times.

**Bubble reference:** Calibrate the eBubble against a properly calibrated physical bubble. The accuracy of the eBubble depends totally on the accuracy of the physical bubble used to calibrate it.

**Pole stability:** When calibrating the eBubble, the pole the active target is on should be as vertical and as stable as possible. In practice this means using at least a tripod to hold the pole as still as possible.

**Pole straightness:** A bent pole will affect the tilt measured by the sensors in the active target. If you calibrate the eBubble using a bent pole and then change poles, the accuracy of points will be affected. Also, if you calibrate using a straight pole and then change to a bent pole, the target will not be plumb even though the eBubble will say it is, again affecting the accuracy of the measured points.

**Abuse:** If the active target suffers severe abuse such as a pole drop, you should recalibrate the eBubble.

For more information, refer to the active target documentation.

### eBubble display

To display the eBubble, tap the **eBubble** softkey.

Bubble color	Meaning
Green	You are within the defined tilt tolerance.
Red	You are outside the defined tilt tolerance.

### TIP –

- To move the eBubble window to a new position on the screen, tap and hold on the eBubble and drag to a new position.
- To show or hide the eBubble from any screen, press **Ctrl + L**.

### Instrument settings

To view the **Instrument settings** screen:

- Tap ☰ and select **Instrument / Instrument settings**.
- Tap and hold the instrument icon in the status bar.

Depending on the instrument that the controller is connected to, the following functions may be available:

#### Instrument name, type, serial number and firmware version

The instrument name, type, instrument serial number, and firmware version details are stored in the job file, and can be output to a report when [exporting job data](#).

#### Reticule illumination

Use the **Reticule illumination** control to illuminate the crosshair. This is useful when the crosshair is not easily visible, for example when in a tunnel.

#### Target test

The target test is used primarily in Survey Basic when measuring a distance that is to be displayed as a dead record.

If the instrument is moved more than 30 cm from where the last measurement was observed, the HA and VA are updated but the SD reverts to "?" to avoid mistaking the next target's distance for the previously measured target's distance.

#### Auto focus

When the **Auto focus** check box is selected, the instrument automatically focuses whenever it automatically turns to a point.

### **NOTE -**

- *New instruments are shipped with auto focus calibrated in the factory. When upgrading from an older version of the instrument firmware, you must first calibrate auto focus using the **Adjustment / Auto focus calib.** function on the instrument face 2 display.*
- *If heights are not known, the computed slope distance cannot be determined and the instrument will be focused based on the horizontal distance instead.*

### Service information

Conventional instruments should be serviced regularly. To check when the instrument is due for the next service, tap **Instrument / Instrument settings / Service**. For some instruments, a service warning message appears when the instrument is due for service. When this message appears, you can still use the instrument, but you should contact your Spectra Geospatial distributor at your earliest convenience to organize servicing.

### PIN

To enable PIN lock security on the instrument, tap **PIN** and then enter and confirm the PIN. The PIN can be any 4-digit numeric value except 0000.

When the PIN function is enabled, the **Unlock instrument** screen appears when connecting to the instrument. Enter the PIN and then tap **Accept**.

If the instrument is locked and you don't know your PIN, contact your Spectra Geospatial distributor for help.

To change the PIN, tap **Instrument / Instrument settings / PIN**, enter the current PIN and then enter and confirm the new PIN.

To remove PIN lock security, tap **Instrument / Instrument settings / PIN**, enter the current PIN and then tap **None**. The software changes the PIN to 0000, which means that no PIN lock security is set.

**TIP -** PIN lock security can also be enabled using the **Security** option the face 2 display of the instrument.

### Instrument adjustment

Tap  and select **Instrument / Adjust** to perform instrument adjustments. The procedures available in the **Adjust** screen depend on the connected instrument.

**NOTE -** The **Adjust** screen is not available during a survey. End the current survey to perform an instrument adjustment.

Spectra Geospatial recommends carrying out instrument adjustment tests in the following situations:

- Whenever the instrument may have been roughly handled during transport.
- When the ambient temperature differs by more than 10°C (18°F) from the previous collimation test.
- Immediately prior to high precision angle measurements in one face.

This help provides instructions for performing the tests using the Origin software running on the controller. Depending on the instrument, you may also be able to perform these tests through the face 2 menu display. For more information, refer to the documentation for your instrument.

#### To adjust a FOCUS 30/35 total station

1. Set up the instrument on a stable surface.
2. Make sure that the instrument is accurately leveled and that the compensator is enabled.
3. Tap  and select **Instrument / Adjust**.

The procedures available in the **Adjust** screen depend on the connected instrument.

4. Perform each adjustment in turn, using the steps below.

#### Collimation error

1. Position the instrument so that the angle to the point is less than 4°30' (5 gon) from the horizontal plane.
2. Select **Collimation**.

Current adjustment values for the instrument are shown.

3. Tap **Next**.
4. Aim at the point and take the collimation measurement.

**NOTE** – Do not use **Autolock** during collimation or trunnion axis tilt tests.

You must take a minimum of one observation on each face. If you take more than one observation, complete all observations on face 1 first. Between each observation, turn the instrument away and then re-aim.



5. To change face, tap **Chg face** and observe the same number of observations on face 2 as you observed on face 1.
6. When the number of observations is the same for both faces, tap **Results**.  
The current values and the new instrument values are shown.
7. Tap **Accept**.

#### Trunnion axis tilt correction

1. Position the instrument so that the angle to the point is less than  $13^{\circ}30'$  (15 gon) from the horizontal plane.
2. Select **Trunnion axis tilt**.  
Current adjustment values for the instrument are shown.
3. Tap **Next**.
4. Aim at the point and take the trunnion axis tilt measurement.

**NOTE** – Do not use **Autolock** during collimation or trunnion axis tilt tests.

You must take a minimum of one observation on each face. If you take more than one observation, complete all observations on face 1 first. Between each observation, turn the instrument away and then re-aim.

5. To change face, tap **Chg face** and observe the same number of observations on face 2 as you observed on face 1.
6. When the number of observations is the same for both faces, tap **Results**.  
The current values and the new instrument values are shown.
7. Tap **Accept**.

#### Autolock collimation

**NOTE** – Autolock collimation should be performed after the HA VA Collimation adjustment, if available, has been completed.

1. Select **Autolock collimation**.
2. Follow the prompts.

- Sight to a target on face 1 with a slope distance between 20 m and 300 m and within 4°30 (5 gon) of horizontal.

### Data output

You can output measurement data to another device such as an echo sounder or a computer running third-party software.

Data output is supported by any supported conventional instrument. Your equipment setup depends on the equipment you are using. Connect the controller to the instrument and connect the device to the controller to output data from the controller to the device.

To enable data output:

- Tap  and select **Instrument / Data output**.
- Set the **Streamed data** to either **After measurement** or **Continuous**.
- Select the **Streamed format**.

If you select **GDM user defined**:

- Select the GDM data labels to include. See [GDM data output, page 338](#).
  - Select the **End of transmission** character.
  - Select the **Time output**.
- If necessary, configure the **Port details**.
  - Leaving the **Data output** screen open, tap  to access other functions in the software.

Data output remains enabled as long as the **Data output** screen is open.

To stop data output, tap **Stop in the Data output screen**, or close the **Data output** screen.

### GDM data output

If you select **GDM user defined** as the **Streamed format**, you can select from the following labels:

Label	Text	Description
7	HA	Horizontal angle
8	VA	Vertical angle
9	SD	Slope distance
10	VD	Vertical distance

Label	Text	Description
11	HD	Horizontal distance
37	N	Northing
38	E	Easting
39	ELE	Elevation
51	Date	Date
52	Time	Time

Before the system can output northing, easting, and elevation, you must complete a station setup. Otherwise, the system outputs 0, 0, 0.

The northing, easting, elevation, angle and distance units match the Origin software setting.

To set the number of decimal places for the horizontal angle and vertical angle records, in the **Jobs** screen tap **Properties**. Tap the **Units** button and then select the appropriate option in the **Angle display** field.

If streamed output is on and no new distance is available, the HA and VA labels are sent rather than the user defined labels.

When using Autolock mode, the instrument must be locked onto a target for any GDM data to be sent.

### Pseudo NMEA GGA output

Use the **Pseudo NMEA GGA** data output option to stream northing, easting, and elevation values, rather than the standard latitude, longitude, and altitude values, from the controller to the connected instrument. This output format is based on the NMEA (National Marine Electronics Association) standard for interfacing marine electronic devices. A modified version of one of the NMEA 'sentences', the GGA sentence, is generated.

A typical example of an output record is:

```
$GPGGA,023128.00,832518.67,N,452487.66,E,1,05,1.0,37.48,M,0.0,M,0.0,0001*49
```

The fields in this record are as follows:

Field	Description
\$GPGGA	Data type identifier for the NMEA sentence
023128.00	Time field – UTC time of position fix (hhmmss.ss)
832518.67	North coordinate in the currently set units output to 2 decimal places
N	Fixed text indicating preceding value was the north coordinate

Field	Description
452487.66	East coordinate in the currently set units output to 2 decimal places
E	Fixed text indicating preceding value was the east coordinate
1	Fix quality (always output as 1 = GPS fix)
05	Number of satellites (not applicable in this case and always output as 05)
1.0	HDOP value (not applicable in this case and always output as 1.0)
37.48	Elevation value in the currently set units output to 2 decimal places
M	Units identifier for elevation value (also indicates units for north and east values). M or F indicating meters or feet (US survey feet or international feet - both use the F output as there is no means of indicating which feet unit)
0.0	Geoidal separation (always output as 0.0 since an elevation value is being output)
M	Units identifier for the geoidal separation (always output as M)
0.0	Time in seconds since last DGPS update (not applicable in this case and always output as 0.0)
0001	DGPS base station ID (not applicable in this case and always output as 0001)
*49	Record checksum value with * separator.

If there are no coordinate values available for output in the Pseudo NMEA GGA sentence, the north, east, and elevation comma-separated fields in the record are empty.

For information on outputting NMEA from the GNSS receiver, see [NMEA output options, page 364](#).

### SD, Hz, V1(mils) output

Use the **SD, Hz, V1(mils)** data output option to stream slope distance, horizontal angle, and vertical angle values.

A typical example of an output record is: **SD 2.76 Hz 253.49 V1 83.47**

The fields in this record are as follows:

Field	Description
Column 37 and 38 are label <b>SD</b>	Slope distance comes after SD label, output to 2 decimal places, right justified at column 50.
Column 52 and 53 are label <b>Hz</b>	Horizontal angle comes after Hz label, output to 2 decimal places, right justified at column 66.

Field	Description
Column 68 and 69 are label <b>V1</b>	Vertical angle comes after V1 label, output to 2 decimal places, right justified at column 78.

**NOTE** – Slope distance is always output in meters and horizontal angle and vertical angle in mils, independent of the units selected in the job properties.

### Auxiliary GPS settings

Auxiliary GPS devices include GPS devices integrated into tablets or third-party GPS devices connected via Bluetooth. Auxiliary GPS can be used during a conventional survey for GPS search, navigating to a point, and to display the position in the map.

To configure auxiliary GPS settings:

1. Tap  and select **Settings / Connections**.
2. Select the **Auxiliary GPS** tab.
3. Select an auxiliary GPS receiver. Choose from:
  - **None**
  - **Internal GPS** – for supported controllers
  - **Custom** – set the controller port as appropriate
4. To connect the controller to a third-party GPS device connected using Bluetooth, select the **Bluetooth** tab in the **Connections** screen and select the device in the **Connect to auxiliary GPS** field. For more information, see [Bluetooth connections, page 433](#).

To make sure you are getting positions from the internal GPS, tap  and select **Instrument / Position**. Tap **Options** and set the **Coordinate view** to **Global**

### Station setup details

To view the instrument type and current station setup information when the controller is connected to a mechanical instrument:

- Tap the instrument icon in the status bar.
- Tap  and select **Instrument / Station setup details**.

## GNSS surveys

In a **GNSS survey**, the controller is connected to the rover or base GNSS receiver. For a list of the GNSS receivers that can be connected, see [Supported equipment, page 6](#).

The steps for completing measurements using a GNSS receiver are:

1. Configure the survey style.
2. If you are setting up your own base station, set up your survey equipment at the base and start the base survey.
3. Set up the rover receiver equipment.
4. Start the rover survey.
5. If you need to convert **Global** coordinates into local grid coordinates (NEE), perform a [site calibration](#).
6. Measure or stake out points.
7. End the survey.

### GNSS survey styles

All surveys in Spectra Geospatial Origin are controlled by a survey style. Survey styles define the parameters for configuring and communicating with your equipment, and for measuring and staking points. This whole set of information is stored as a template and used each time you start a survey.

The type of GNSS survey you will use will depend on available equipment, field conditions, and the results required. Configure the style only if the default settings do not suit your needs.

**NOTE** – *When you start the survey, the Origin software checks the settings in the survey style to make sure they are appropriately configured for the equipment you are connected to. For example, if GLONASS is enabled in the survey style it checks if the connected GNSS receiver or antenna also supports GLONASS. If the Origin software detects an incorrect setting, or if it detects that the settings in the survey style have not been checked, it prompts you to confirm or correct the settings. Any changed settings are saved to the survey style.*

### Real-Time Kinematic surveys

The default GNSS survey style is **RTK (Real-Time Kinematic)**. Real-time kinematic surveys use a [data link](#) to send observations or corrections from the base station to the rover. The rover then calculates its position in real time. Select the required data link type in the **Data link options** screen when you configure the RTK survey style.

### Network RTK surveys

**Network RTK** systems consist of a distributed network of reference stations communicating with a control center to calculate GNSS error corrections over a wide area. Real-time correction data is transmitted by radio or cellular modem to the rover receiver within the network area. The system improves reliability and operating range by significantly reducing systematic errors in the reference station data. This lets you increase the distance at which the rover receiver can be located from the physical reference stations, while improving on-the-fly (OTF) initialization times.

Select the required **Broadcast format** in the **Rover options** screen when you configure the RTK survey style. Origin supports broadcast formats from the following network RTK solutions:

- FKP (RTCM)
- VRS

To store VRS vectors to the nearest Physical Base Station (PBS) in the VRS network, the VRS system must be configured to output the PBS information. If the VRS system does not output PBS data, VRS data must be stored as positions.

**NOTE** – *If you are using a radio in a VRS system, you must select a two-way radio. You cannot use Spectra Geospatial internal 450 MHz or 900 MHz radios.*

### Other GNSS survey types

To use one of the following survey types, you must create your own survey style:

- **FastStatic** – a postprocessed survey using occupations of up to 20 minutes to collect raw GNSS data. The data is postprocessed to achieve subcentimeter precisions.
- **Postprocessed Kinematic** – postprocessed kinematic surveys store raw stop-and-go and continuous observations. The data is postprocessed to achieve centimeter-level precisions.
- **Real-Time Kinematic and Infill** – allows you to continue a kinematic survey when radio contact with the base station is lost. The infill data must be postprocessed.
- **Real-Time Kinematic and Data Logging** – records raw GNSS data during an RTK survey. The raw data can be postprocessed later, if required.

- **Real-Time Differential Survey** – uses the differential corrections transmitted from a land-based receiver or from SBAS satellites to achieve submeter positioning at the rover.

## To configure the GNSS survey style

1. Tap  and select **Settings/ Survey styles**.
2. Do one of the following:
  - Tap **<Style name>** and then tap **Edit**.
  - Tap **New**. Enter a name for the style and then tap **Accept**.
3. Select each of the options in turn, and set them to suit your equipment and survey preferences.

To...	See...
configure settings for the receiver and survey type	<a href="#">Receiver options and data links, page 344</a>
set parameters for GNSS points	<a href="#">GNSS point options, page 356</a>
configure stakeout settings	<a href="#">Stakeout options, page 359</a>
configure the software to warn when duplicate points are measured	<a href="#">Duplicate point tolerance options, page 362</a>
use a laser rangefinder	<a href="#">Laser rangefinders, page 426</a>
use an echo sounder	<a href="#">Echo sounder instruments, page 429</a>
output NMEA messages	<a href="#">NMEA output options, page 364</a>

4. Tap **Store**.

### Receiver options and data links

Configure receiver settings in the **Rover options** and **Rover data link** screens in the survey style. Depending on the options you select in the **Rover options** screen, other screens and fields become available in the survey style.

If the receiver will operate in Base mode, configure receiver settings in the **Base options** and **Base data link** screens.



### Rover options

The fields available in the **Rover options** screen are similar for all GNSS survey types. All fields that appear in the **Rover options** screen for any GNSS survey type are described below.

### Survey type

Select the type of survey you want to use. The rest of the fields in the screen update to reflect the survey type selected.

Generally, when a GNSS surveying system setup consists of one base and one rover receiver, make sure that the survey type selected in the **Rover options** field and the **Base options** field is the same. However, when there are multiple rovers, you can have various configurations but make sure that if the rover is logging raw data your base station is also logging raw data.

### Antenna settings

Select the correct antenna from the list of antennas. The **Part number** field automatically displays the part number.

Select the correct measurement method for the equipment and type of survey. To set the default antenna height, enter a value in the **Antenna height** field. The **Part number** field automatically displays the part number.

Enter the serial number.

### Tilt functions

When using a Spectra Geospatial SP80 or SP85 receiver, select the **Tilt functions** check box so that the **Tilt warnings** and **Auto-measure** options are available in the appropriate point style settings. Enabling this check box also makes the **Compensated point** measurement method available in the **Measure** screen.

### Elevation mask

You must define an elevation mask below which satellites are not considered. For kinematic applications, the default of  $10^\circ$  is ideal for both the base and rover.

For differential surveys where the base and rover are separated by more than 100 kilometers, Spectra Geospatial recommends that the base elevation mask be lower than the rover setting by  $1^\circ$  per 100 kilometers of separation between the base and rover. Generally, the base elevation mask should be no lower than  $10^\circ$ .

### PDOP mask

Define a PDOP mask for the rover. When the satellite geometry goes above the set PDOP mask, the software issues high PDOP warnings, pauses the time to initialize counter (PPK surveys), and suspends the measurement of a FastStatic point. Initialization and measurement resumes when the

PDOP drops below the mask. The default value is 6.

### Real-time survey settings

#### Broadcast format

The broadcast message format generated by the rover depends on the selected survey type.

- For real-time kinematic surveys, the format of the broadcast message can be CMR, CMR+, CMRx, or RTCM RTK.

The default is CMRx. It is a compressed data format designed to handle the extra load of additional GNSS signals from modernized GPS, GLONASS, Galileo, QZSS, and BeiDou.

The broadcast format RTCM v2.3 must not be used with Spectra Geospatial receivers in the Origin software.

- For network RTK surveys, the broadcast message format can be from the following network RTK solutions: FKP (RTCM), VRS (CMR), VRS (RTCM).
- Networked single base RTK is also supported in the form of "multi station" surveys with both CMR and RTCM formats. These surveys enable you to connect to a network service provider through the Internet, and receive CMR or RTCM data from the nearest physical reference station in the network.
- For RTX surveys, the **Survey type** must be **RTK** and the **Broadcast format** must be **RTX (SV)** or **RTX (Internet)**.

If you select **RTX (Internet)**, in the **Rover data link** screen select the GNSS contact you have set up for the RTX Internet service. This GNSS contact must have the **Use RTX (Internet)** check box selected and the appropriate **Mountpoint name** selected. See [To create a GNSS contact for a rover Internet data link, page 371](#).

- For real-time differential surveys, the **Broadcast format** must be **RTCM** for land-based transmissions. For satellite-based transmissions, select **SBAS**.

#### Satellite differential

When the radio link is down in a real-time survey, the receiver can track and use signals from [SBAS](#).

### Postprocessed survey settings

#### Logging device

With survey types that involve postprocessing, the **Logging device** field is set to the receiver.

### Logging interval

To define the logging interval, enter a value in the **Logging interval** field. The base and rover logging intervals must correspond to (or be multiples of) each other.

When using an RTK and Infill survey type, the **Logging interval** is for the infill session only.

When using an RTK and data logging survey type, the **Logging interval** should be the same for each receiver – typically 5 seconds. The **RTK interval** remains at 1 second.

### Auto file names

To define the logging file name, clear the **Auto file names** check box and then enter the file name in the **Logging file name** field.

### Log data in RTK mode

Select this option to log raw data in the RTK part of an **RTK & infill** survey type. Use this option if you want postprocessed data stored as a backup to your RTK survey. When this option is selected, switching between Infill and RTK modes does not suspend logging.

### GNSS signal tracking

To use observations from a GNSS constellation in a real-time or postprocessed survey, you must enable tracking for each signal type you want to use in both the **Rover options** and the **Base options** screens. See [GNSS signal tracking options, page 349](#).

### Base options

**NOTE** – The **Base options** screen becomes available when you set the **Broadcast format** in the **Rover options** screen to *CMR*, *CMR+*, *CMRx*, or *RTCM RTK* for the RTK survey type.

### Survey type

Select the type of survey you want to use. The rest of the fields in the screen update to reflect the survey type selected.

Generally, when a GNSS surveying system setup consists of one base and one rover receiver, make sure that the survey type selected in the **Rover options** field and the **Base options** field is the same. However, when there are multiple rovers, you can have various configurations but make sure that if the rover is logging raw data your base station is also logging raw data.

### Antenna settings

Select the correct antenna from the list of antennas. The **Part number** field automatically displays the part number.

Select the correct measurement method for the equipment and type of survey. To set the default antenna height, enter a value in the **Antenna height** field. The **Part number** field automatically displays the part number.

Enter the serial number.

### Elevation mask

You must define an elevation mask below which satellites are not considered. For kinematic applications, the default of 10° is ideal for both the base and rover.

For differential surveys where the base and rover are separated by more than 100 kilometers, Spectra Geospatial recommends that the base elevation mask be lower than the rover setting by 1° per 100 kilometers of separation between the base and rover. Generally, the base elevation mask should be no lower than 10°.

### Real-time survey settings

#### Broadcast format

The broadcast message format generated by the base depends on the selected survey type.

- For real-time kinematic surveys, the format of the broadcast message can be CMR, CMR+, CMRx, or RTCM RTK.

The default is CMRx. It is a compressed data format designed to handle the extra load of additional GNSS signals from modernized GPS, GLONASS, Galileo, QZSS, and BeiDou.

The broadcast format RTCM v2.3 must not be used with Spectra Geospatial receivers in the Origin software.

### Postprocessed survey settings

#### Logging device

With survey types that involve postprocessing, the **Logging device** field is set to the receiver.

#### Logging interval

To define the logging interval, enter a value in the **Logging interval** field. The base and rover logging intervals must correspond to (or be multiples of) each other.

When using an RTK and Infill survey type, the **Logging interval** is for the infill session only.

When using an RTK and data logging survey type, the **Logging interval** should be the same for each receiver – typically 5 seconds. The **RTK interval** remains at 1 second.

## GNSS signal tracking

To use observations from a GNSS constellation in a real-time or postprocessed survey, you must enable tracking for each signal type you want to use in both the **Rover options** and the **Base options** screens. See [GNSS signal tracking options, page 349](#).

### GNSS signal tracking options

To use observations from a GNSS constellation in a real-time or postprocessed survey, you must enable tracking for each signal type you want to use in both the **Rover options** and the **Base options** screens. In a real-time survey the tracked signals are sent in the RTK data stream. In a postprocessed survey the tracked signals are saved in the logged data.

### **NOTE -**

- *GNSS signals tracked by the rover receiver must also be tracked by the base receiver.*
- *If you enable tracking of satellite signals that are not being tracked by the base or contained in the RTK messages coming from the base, then those signals will not be used in RTK at the rover.*
- *To save receiver battery power, enable only those signals available in the base data you are going to use.*
- *GNSS surveys with firmware earlier than version 6.00 must contain either GPS or BeiDou observations. If you disable GPS in a GNSS survey, BeiDou is automatically enabled.*

## GPS

In a real-time survey, the **GPS** check box is available only when the **Broadcast format** is set to:

- RTCM RTK
- Multistation RTCM
- CMRx format

To disable the use of GPS in these surveys, clear the **GPS** check box. If GPS signal tracking is disabled, BeiDou signal tracking is automatically enabled because surveys must contain either GPS or BeiDou data.

If you disable GPS at the rover for RTK you can use either the CMRx or RTCM v3.2 MSM broadcast format. Disabling GPS at the base can only be done for the RTCM v3.2 MSM broadcast format. For CMRx transmission from the base, GPS must remain enabled even though GPS can be disabled at the rovers that are using that CMRx base.

For other real-time survey types, the GPS field is read-only.

In a postprocessed survey, the **GPS** check box is always available.

For real-time surveys where the base data contains L2C observations, select the **GPS L2C** check box.

The **Use L2e** setting is read-only.

The **L5** check box is available only when the **Broadcast format** is set to CMRx or RTCM RTK 3.2 (MSM).

## GLONASS

The **GLONASS** check box is always available.

In a real-time survey, you can enable GLONASS satellite tracking at the rover even if the base receiver is not tracking GLONASS. However, the satellites will not be used in the RTK processing.

## Galileo

The **Galileo** check box is available only when GPS signal tracking is enabled.

In a real-time survey, the **Galileo** check box is available only when GPS signal tracking is enabled and the **Broadcast format** is set to:

- CMRx
- RTCM RTK 3.2 (MSM)
- RTX

In a logging survey (Fast static, PPK, RTK, and logging), the **Galileo** check box is available only when the **Logging device** is set to **Receiver**.

**NOTE** – *If you enable Galileo tracking, the satellites will be used in the solution when they are healthy.*

## QZSS

In a real-time survey, the **QZSS** check box is available only when GPS signal tracking is enabled and the **Broadcast format** is set to:

- CMRx
- RTCM RTK 3.2 (MSM)
- RTX

To fall back to QZSS SBAS positioning if your RTK radio link goes down, select **SBAS** in the **Satellite differential** field, and select the **QZSS** option. In this case, the **QZSS** option is only available if the **Broadcast format** is set to **CMRx**.

In a logging survey (Fast static, PPK, RTK, and logging), the **QZSS** check box is available only when the **Logging device** is set to **Receiver**.

## BeiDou

In a real-time survey, the **BeiDou** check box is available only when the **Broadcast format** is set to:

- CMRx
- RTCM RTK 3.2 (MSM)
- RTX

In a logging survey (Fast static, PPK, RTK, and logging), the **BeiDou** check box is available only when the **Logging device** is set to **Receiver**.

When BeiDou signal tracking is enabled in an SBAS differential survey, the BeiDou SVs are used to augment the solution if their corrections are available.

## NavIC

For FastStatic surveys where the base and rover receivers can track IRNSS/NavIC signals, select the *NavIC* check box.

**NOTE** – *NavIC data can only be logged to the receiver. As NavIC satellites are tracked on L5 only they are not included in the point timers which rely on dual-frequency data.*

## RTK survey data links

Real-time kinematic surveys can use a data link to send observations or corrections from the base station to the rover. The rover then calculates its position in real time.

To check the status of the data link during an RTK survey, tap the **Real-time correction** icon in the status bar or the **GNSS functions** screen. You can also configure the data link from the **Data link** status screen.

To obtain RTK data by:

- Radio connected to the controller and communicating with the radio at the base station, use a **radio data link**. See [RTK radio data link, page 366](#).
- Cellular phone or modem connected to an Internet server using an IP address, use an **Internet data link**. See [RTK Internet data link, page 370](#).

## RTX correction service

The Trimble Centerpoint RTX™ correction service is a high-accuracy, precise point positioning (PPP) system that provides real-time centimeter positioning without the need for an RTK base station or VRS network.

Survey using satellite-delivered or Internet-delivered Trimble RTX corrections in open areas where terrestrial-based corrections are not available. When surveying over a great distance in a remote area, such as a pipeline or utility right of way, Trimble RTX technology eliminates the need to

continuously move the base station or, when using satellite-delivered corrections, to maintain connection to cell coverage.

### RTX subscriptions

If you have a Spectra Geospatial receiver that supports Trimble RTX technology and has the appropriate subscription you can use the Trimble Centerpoint® RTX correction service.

The Trimble RTX subscription expiry date is displayed in the **Instrument / Receiver settings** screen. Trimble RTX subscriptions which have been purchased as blocks of hours operate within a validity window, which is the start date and end date between which the number of hours/minutes purchased must be used.

For more information, go to [www.trimble.com/positioning-services](http://www.trimble.com/positioning-services).

### Configuring an RTX survey

To configure an RTX survey, create an RTK survey style with the broadcast format set to satellite **RTX (SV)** or an Internet connection **RTX (Internet)**.

If you select **RTX (Internet)**, in the **Rover data link** screen select the GNSS contact you have set up for the RTX Internet service. This GNSS contact must have the **Use RTX (Internet)** check box selected and the appropriate **Mountpoint name** selected. See [To create a GNSS contact for a rover Internet data link, page 371](#).

### Convergence times

In typical conditions, the RTX convergence time is 30 minutes or less when static. The convergence time varies based on GNSS constellation health, level of multipath, and proximity to obstructions, such as large trees and buildings.

Convergence times given are a guide only. Convergence may take longer in adverse environments.

### Reference frame

Coordinates measured in surveys using the Trimble CenterPoint RTX service are stored in the ITRF 2014 reference frame at the epoch of measurement. When you start an RTX survey, Origin uses the local displacement model, or if no local model is available for your location, the software selects a tectonic plate in the global tectonic plate model, to propagate the ITRF 2014 coordinate from the epoch of measurement to the **Global reference epoch** for the job. Origin then applies a datum transformation to transform the ITRF 2014 coordinate into the **Global reference datum** for the job.



## RTX-RTK offsets

As described above, Origin transforms RTX coordinates into the **Global reference datum** for the job. However, there may be times that RTK data does not fit exactly with RTX data. For example:

- There are residual errors between RTX and RTK positions after the transformation.
- The RTK data is based on a **Here** key.
- The RTK data is based on a base station or VRS network that does not use the same **Global reference datum** as the job.
- You are working in an active deformation zone where the global tectonic plate model or the local displacement model does not give good results.

Origin allows RTK data that is not in terms of the **Global reference datum** to be combined with RTX data in the same job by using an **RTX-RTK offset**. These offsets are computed from a precise RTK point and a precise RTX point in the same physical location, and that difference is applied to all measured RTX points to bring them into terms with the RTK data in the job. The raw RTX measurements are stored, and the offset is applied when viewing coordinates or before performing any operations on those RTX measurements such as cogo calculations and stakeout.

When performing a site calibration using RTX measurements when there is an RTX-RTK offset in the job, the offset is applied to bring the RTX measurements into terms with the RTK data before calculating the site calibration. Spectra Geospatial recommends that you finalize a very precise RTX-RTK offset for the job before performing a site calibration using RTX measurements.

When an RTX-RTK offset is applied to a job, the precision estimates of the RTX measurements are inflated by the precision of the RTX-RTK offset using the propagation of variances principle. The precision of the latest offset in the job is applied to all displayed and stored RTX measurements in the job. When the offset is updated, the precision of the new offset is reapplied to all RTX point measurements in the job.

---

 **WARNING** – Take great care to avoid changing the offset already in a job to a less precise offset, as this action may cause the precision of the points stored in the job to no longer meet the precision tolerances applied when the points were measured.

---



To compute an RTX-RTK offset, see [To compute an RTX-RTK offset, page 385](#).

## SBAS

Satellite-based augmentation system (SBAS) signals provide real-time, differentially corrected positions without the need for a radio link. You can use SBAS in real-time surveys when the ground-based radio link is down.

To use SBAS signals, in the **Rover options** screen of your survey style, set **Satellite differential** to SBAS. In real-time differential surveys, you can set the broadcast format to SBAS to always store SBAS positions without the need for a radio link.

For real-time differential surveys where the rover can track the QZSS signals, select **SBAS** in the **Broadcast format** field, and select the **QZSS** option. This enables the rover receiver to track the QZSS satellite and, if you are within the valid QZSS differential network, to use the QZSS SBAS differential corrections in the real-time differential survey.

When SBAS signals are being received, the radio icon  changes to an SBAS icon , and in an RTK survey, **RTK:SBAS** is displayed on the status line.

In an SBAS survey, QC1 quality control information is available, while QC2 and QC3 are not available. The availability of SBAS signals depends on your location. For example:

- WAAS is available in the Americas.
- EGNOS is available in Europe.
- MSAS and QZSS are available in Japan.

#### PP initialization times

If you have set the **Survey type** field to **PP Kinematic** in the **Rover options** screen, the **PPK initialization times** item appears in the list of configuration screens in the survey style.

To define initialization times, tap **PP initialization times**.

To achieve centimeter-level precisions from a PP kinematic survey when the data is processed, the survey must initialize. With dual-frequency receivers, the on the fly initialization process begins automatically if at least five L1/L2 satellites are being observed.

**NOTE** – In a postprocessed survey, only rely on the *On the fly (automatic) initialization* if you are certain that the receiver will observe at least 5 satellites without interruption for the next 15 minutes, or 6 satellites without interruption for the next 8 minutes. Otherwise, [initialize on a known point](#).

During initialization, enough data is collected so that the postprocessing software can successfully process it. Recommended initialization times are:

Initialization method	4 SVs	5 SVs	6+ SVs
L1/L2 on-the-fly initialization	N/A	15 min	8 min
L1/L2 new point initialization	20 min	15 min	8 min
Known Point initialization	At least four epochs		

**NOTE –**

- Generally the recommended times are appropriate. Reducing any of these times can affect the outcome of a postprocessed survey.
- You cannot initialize if the PDOP is greater than 20.
- The time to initialize counters are paused when the PDOP of the satellites being tracked exceeds the PDOP mask set in the survey style being used. The counters resume when the PDOP falls below the mask.

After initialization, the survey mode changes from **Not initialized** to **Initialized**. The mode remains **Initialized** if the receiver continuously tracks the minimum number of satellites. If the mode changes to **Not initialized**, you must reinitialize the survey.

**On-the-fly initialization and new point initialization**

If you do an On-The-Fly initialization in a postprocessed kinematic survey, you can measure points before initialization is gained. The Survey Office software can process the data later to give a centimeter-level solution. If you do this but lose lock on the satellites while initializing, remeasure any one of the points that you surveyed before lock was lost.

The number of satellites required depends on whether you are using satellites from only one constellation or a combination of constellations. After initialization, a position can be determined and the initialization can be maintained with one satellite less than the number required to initialize. If the number of satellites drops below this number, the survey must be reinitialized.

Satellite systems	Required satellites for initialization	Required satellites to produce positions
GPS only	5 GPS	4 GPS
GPS + QZSS	4 GPS + 1 QZSS	3 GPS + 1 QZSS
GPS + GLONASS	4 GPS + 2 GLONASS	3 GPS + 2 GLONASS
GPS + BeiDou	4 GPS + 2 BeiDou	3 GPS + 2 BeiDou
GPS + Galileo	4 GPS + 2 Galileo	3 GPS + 2 Galileo
BeiDou only	5 BeiDou	4 BeiDou
BeiDou + GPS	4 BeiDou + 2 GPS	3 BeiDou + 2 GPS
BeiDou + GLONASS	4 BeiDou + 2 GLONASS	3 BeiDou + 2 GLONASS

GLONASS only	-	-
Galileo only	-	-

**NOTE** - The QZSS system operates in the same time-base as GPS and therefore is included in the counters as another GPS satellite.

### GNSS point options

As part of configuring the survey style for a GNSS survey, you can configure the parameters for the points measured during the survey.

To configure these settings, tap  $\equiv$  and select **Settings / Survey styles / <style name> / <point type>**.

### Auto point step size

Sets the increment size for automatic point numbering. The default is **1**, but you can use larger step sizes and negative steps.

### Quality control

You can store quality control information with each point measurement except compensated points. Options may include **QC1**, **QC1 & QC2**, and **QC1 & QC3**, depending on the type of survey. All values at 1 sigma level, except horizontal and vertical precision estimates which are shown at the configured confidence level, set in the **Precision display** field of the [Units, page 91](#) screen.

#### Quality control 1: SVs, DOP and Time

Number of satellites (minimum for the occupation, number at time of storage, and list of SVs used in the solution), Flag for Relative DOPs (or not, used for legacy firmware that produced RDOP when static), DOP (maximum for duration of occupation), DOP at time of point storage, Number of GPS positions used in the occupation (this is the number of epochs within precision tolerance observed), Horizontal standard deviation and Vertical standard deviation field are unused (set to null), Start GPS week (the GPS week when you hit Measure), Start GPS time in seconds (the GPS second of week when you hit Measure), End GPS Week (the GPS week the point was stored), End GPS time in seconds (the GPS second of week when the point was stored), Monitor Status (not used, will be null or not visible), RTCMAge (age of corrections used in RTK solution), Warnings (which warning messages were issued during the occupation or in effect when the point was stored).

#### Quality control 2: Variance/Covariance matrix of the RTK solution

Error scale (added trace of covariance matrix divided by PDOP, used to convert DOPs into precisions in legacy systems), VCV xx, VCV xy, VCV xz, VCV yy, VCV yz, VCV zz (these are all a-posteriori variances from the stored epoch of the RTK solution), Unit Variance (standard error of unit weight, always set to 1.0 for HD-GNSS, not available in some legacy systems). All values at 1-sigma level.

#### Quality control 3: Error ellipse of RTK solution

This is in local tangent plane and is calculated directly from VCVs using standard textbook formulae. Sigma north (standard deviation in the north component), Sigma east (standard deviation in the east component), Sigma up (standard deviation in the Up or height component), Covariance east-north (measure of the correlation between the east error and the north error), Semi major axis length of error ellipse in meters, Semi minor axis length of error ellipse in meters, Orientation from north of error ellipse, Unit variance of solution. All values at 1-sigma level.

### Auto-store point

Select the **Auto store point** check box to automatically store the point when the preset occupation time and precisions have been met.

This check box does not appear in the Rapid point measurement options because rapid points are always stored automatically.

### Occupation time and number of measurements

The **Occupation time** and **Number of measurements** together define the time that the receiver is static while measuring a point. The criteria for both must be met before the point can be stored. The **Occupation time** defines the length of clock time for the occupation. The **Number of measurements** defines the number of valid sequential GNSS measurement epochs that meet the currently configured precision tolerance that must occur during the period of the occupation time. When the **Occupation time** and **Number of measurements** criteria have been met, **Store** is available. Alternatively, if **Auto store point** is enabled, the point is stored automatically.

**NOTE** – *For compensated points and observed control points measured during an RTK survey, the horizontal and vertical precisions must also be satisfied before the point can be stored.*

If a point is stored manually when the precision tolerances are not met, the number of measurements that meet the precision criteria will be zero, and this is what will appear in the point record in **Review job**.

The requirement for sequential epochs that meet the precision criteria means the occupation counters will be reset if the precision goes outside the tolerances at any time during the occupation.

In an RTK survey, the RTK engine in the GNSS receiver converges on a solution during the occupation and it is this converged solution that is saved in the job file when the point is stored.

In a FastStatic survey, the default occupation times are satisfactory for most users. If you change an occupation time, choose a setting according to the number of satellites being tracked by that receiver.

**NOTE** – *Changing the occupation times directly affects the outcome of a FastStatic survey. Any changes should increase this time rather than decrease it. If you do not record enough data, the points may not be successfully postprocessed.*

## Precision

In an RTK survey, set the **Auto tolerance** switch to **Yes** to enable the software to calculate horizontal and vertical precision tolerances that meet the GNSS receiver's RTK specifications for the baseline length you are measuring. To enter your own precision settings at which point storage is acceptable, set the **Auto tolerance** switch to **No** and then enter the required **Horizontal tolerance** and **Vertical tolerance**.

If the receiver is an older receiver, the **Store RTK initialized only** check box is available. Select the **Store RTK initialized only** check box to store only Initialized RTK solutions that meet the precision tolerances. Uninitialized solutions that meet the precision tolerances cannot be stored. When **Store RTK initialized only** is not selected, both RTK Initialized and Uninitialized solutions that meet the precision tolerances can be stored.

## Auto-measure

If you are using a GNSS receiver that supports the [GNSS eBubble](#), you can use **Auto-measure** to automatically initiate a measurement from within the **Measure points** screen.

Enable the **Auto-measure** check box in the survey style, or tap **Options** in the **Measure points** screen.

When using **Auto-measure**, the measurement will begin automatically when the pole is within tilt tolerance. If the pole is not within tilt tolerance, the **Status** field shows **Waiting for level**. Use the [GNSS eBubble](#) to level the receiver and make sure the pole is vertical and stationary. When the pole is within tilt tolerance, the status bar shows  and the software automatically begins measuring the point.

## Tilt functions

If you have selected the **eBubble functions** or **Tilt functions** check box in the **Rover options** screen of the survey style, select the **Tilt warnings** check box to display warning messages if the antenna tilts more than the threshold value entered in the **Tilt tolerance** field. You can specify a different **Tilt tolerance** value for each measurement type. See [GNSS eBubble tilt warnings, page 412](#).

## Auto abandon

To automatically abandon points when the position is compromised, such as where excess movement is detected during the measurement process, select the **Auto abandon** check box.

## Store low latency positions

This check box only appears in the **Continuous topo** measurement method options when you do not have Trimble RTX enabled.

When you select the **Store low latency positions** check box, the measurements are made by the receiver in low latency mode. Low latency is more suitable when using continuous topo with distance based tolerances.

When **Store low latency positions** is not enabled, measurements from the receiver are synchronized on the epoch resulting in slightly more accurate positions, and is more suitable when using continuous topo with time-based tolerances.

**TIP** – If using Continuous topo as a static test to check the quality of measured positions make sure **Store low latency positions** is not enabled.

### Stakeout options

To configure stakeout options in the survey style, tap  and select **Settings / Survey styles / <Style name> / Stakeout**.

**TIP** – To change the stakeout options during stakeout, tap **Options** in the stakeout screen.

### As-staked point details

**As-staked point details** are shown in stakeout reports generated from the **Export** screen, and they are shown on the **Confirm staked deltas** screen that appears when you enable **View before storage**.

To configure **As-staked point details**, see [As-staked point details, page 511](#).

### Display

Use the **Display** group to configure the appearance of the navigation display during stakeout.

#### To configure the display for a conventional survey

Set the **Show stakeout graphics** switch to **Yes** to show the navigation graphics in the navigation screen. Setting the switch to **Yes** enables the other fields in the **Display** group.

**TIP** – If you are using a controller with a smaller screen, or you want to fit more navigation deltas on the screen, set the **Show stakeout graphics** switch to **No**. The other fields in the **Display** group are hidden when the switch is set to **No**.

The **Display mode** determines what the navigation display shows during navigation. Select from:

- **Direction and distance** – the stakeout navigation display shows a large arrow pointing in the direction you have to move. When you are close to the point, the arrow changes to the in/out and left/right directions, relative to the instrument.
- **In/out and left/right** – the stakeout navigation display shows in/out and left/right directions, with the conventional instrument as a reference point.

**TIP** – By default the software automatically gives in/out and left/right directions from the **Target perspective** in a robotic survey, and from the **Instrument perspective** when connected to a servo instrument using a face plate or cable. To change this, edit the **Servo/Robotic** settings in the **Instrument** screen of the survey style. See [Instrument configuration, page 278](#).

Use the **Distance tolerance** field to specify the allowable error in distance. If the target is within this distance from the point, the software indicates that the distance is correct.

Use the **Angle tolerance** field to specify the allowable error in angle. If the conventional instrument is turned away from the point by less than this angle, the software indicates that the angle is correct.

Use the **Grade** field to display the grade of a slope as an angle, percent, or ratio. The ratio can be displayed as **Rise:Run** or **Run:Rise**. See [Grade, page 91](#).

To configure the display for a GNSS survey

Set the **Show stakeout graphics** switch to **Yes** to show the navigation graphics in the navigation screen. Setting the switch to **Yes** enables the other fields in the **Display** group.

**TIP** – If you are using a controller with a smaller screen, or you want to fit more navigation deltas on the screen, set the **Show stakeout graphics** switch to **No**. The other fields in the **Display** group are hidden when the switch is set to **No**.

The **Display mode** determines what remains fixed in the center of the screen during navigation. Select from:

- **Target centered** – the selected point stays fixed in the center of the screen
- **Surveyor centered** – your position stays fixed in the center of the screen

The **Display orientation** determines the reference the software orientates to during navigation. Select from:

- **Direction of travel** – the software will orientate so that the top of the screen points in the direction of travel.
- **North / Sun** – the small orientation arrow shows the location of North or the sun. The software will orientate so that the top of the screen points toward North or the sun. When using the display, tap the **North/Sun** softkey to toggle the orientation between north and the sun.
- **Reference azimuth:**
  - For a point the software will orientate to the **Reference azimuth** for the job. The **Stake** option must be set to **Relative to azimuth**.



- For a line or road the software will orientate to the azimuth of the line or road.

**NOTE** – If, when staking a point, the **Display orientation** is set to **Reference azimuth** and the **Stake** option is **not** set to **Relative to azimuth** the display orientation behavior will default to **Direction of travel**. For Stake options, see [GNSS stake methods, page 517](#).

## Deltas

Deltas are the information fields showing during navigation that indicate the direction and distance you need to travel to the entity you want to stake out. To change the deltas shown, tap **Edit**. See [Stakeout navigation deltas, page 508](#).

## DTM

To display the cut or fill relative to a DTM during stakeout, in the **DTM** group box select the DTM file. If required, in the **Offset to DTM** field, specify an offset to the DTM. Tap **▶** and select whether the offset is to be applied vertical or perpendicular to the DTM. The **V.Dist DTM** value is to the offset position.

## Conventional

In a conventional survey, if you do not want the total station EDM set to **TRK** mode when you enter stakeout, clear the **Use TRK for stakeout** check box.

## GNSS

In a GNSS survey, to automatically start measuring when the **Measure** key is tapped, select the **Auto measure** check box.

## Compass

If your Spectra Geospatial controller includes an internal compass, you can use it when staking out a position or navigating to a point. To use the internal compass, select the **Compass** check box.

Spectra Geospatial recommends you **disable** the compass when you are near magnetic fields that may cause interference.

## Removed staked point from list

To automatically remove points from the stake out points list after they have been staked, select the **Remove staked point from list** check box at the bottom of the **Options** screen.

## Duplicate point tolerance options

The duplicate point tolerance options in the survey style determine what happens if you attempt to store a point with the same name as an existing point, or if you measure a point that is very close to an existing point that has a different name.

When configuring these settings, make sure you are familiar with the database search rules applied by the software when managing points of the same name. See [Managing points with duplicate names, page 200](#).

## Same point name options

In the **Same point name** group, enter the maximum horizontal and vertical distances or angles that a new point can be from an existing point of the same name. A duplicate point warning appears only if the new point is outside the tolerance set. To always receive a warning if you measure a point with the same name, enter zero.

## Auto average tolerance

To automatically compute and store the average position of points that have the same name, select the **Auto average** within tolerance option. An averaged position has a [higher search class](#) than a normal observation.

When the **Auto average** option is selected, and an observation to a duplicate point is within the specified duplicate point tolerance settings, the observation and the computed average position (using all the available point positions of the same name) are stored.

You can select the averaging method in the **Cogo settings** screen.

The Origin software computes an averaged coordinate by averaging the grid coordinates computed from the underlying coordinates or observations. Observations that do not allow a grid coordinate to be resolved (for example, angles only observations) are not included in the average coordinate.

If the new point is further from the original point than the tolerance specified, you can choose what to do with the new point when you store it. The options are:

- **Discard** – discard the observation without storing.
- **Rename** – rename to a different point name.
- **Overwrite** – Overwrite and delete the original point, and all other points of the same name and the same (or lower) search class.
- **Store as check** – Store with a lower classification.

- **Store and reorient** – (This option only appears if you are observing a backsight point.) Store another observation that will provide a new orientation for subsequent points measured in the current station setup. Previous observations are not changed.
- **Store another** – Store the point, which can then be averaged in the office software. The original point is used in preference to this point.

If the Store another option is used with multiple observations to a point with the same name and from the same station setup, then when measuring topo points the software automatically computes and records a Mean Turned Angle (MTA) observation to the point. This MTA observation provides the preferential position for the point.

- **Average** – Store the point and then compute and store the averaged position.

When you select **Average**, the current observation is stored and the computed average position appears, along with the computed standard deviations for the north, east, and elevation ordinates. If there are more than two positions for the point, a **Details** softkey appears. Tap **Details** to view the residuals from the average position to each individual position. You can use the **Residuals** form to include or exclude specific positions from the average computation.

#### Face 1 and face 2 observation tolerance

In a conventional survey, when you attempt to measure a point on face 2 that already exists as a face 1 measurement, the software does not warn that the point already exists.

When you carry out two-face observations in a conventional survey during **Station setup**, **Station Setup Plus**, **Resection**, or when measuring **Rounds**, the software checks that the face 1 and the face 2 observations to a point are within a preset tolerance.

If the new point is further from the original point than the tolerance specified, you can choose what to do with the new point when you store it. The options are:

- **Discard** – discard the observation without storing.
- **Rename** – rename to a different point name.
- **Overwrite** – Overwrite and delete the original point, and all other points of the same name and the same (or lower) search class.

- **Store as check** – store with a classification of Check.
- **Store another** – store the observation.

Once you have completed the **Station Setup Plus**, **Resection**, or **Round** measurements, the software saves the Mean Turned Angles to each of the observed points. The software does not check for duplicate points at this stage.

#### Different point name options

To enable proximity check for points with different names, enable the **Proximity check** switch. Enter the horizontal and vertical distance that the new point can be from any existing point.

#### **NOTE –**

- *The vertical tolerance is only applied when the new observed point is within the horizontal tolerance. Use the vertical tolerance to avoid the proximity check warning when new points are measured above or below existing points but are legitimately at a different elevation, for example the top and bottom of a vertical kerb.*
- *The proximity check is only performed on observations, not on keyed in points. The proximity check is not performed in stakeout, GNSS Continuous measurement, or Calibration Point, and it is not performed in jobs with a No Projection coordinate system.*

#### NMEA output options

To output NMEA-0183 format messages from a port on the connected GNSS receiver, configure the settings in the **NMEA outputs** screen of your GNSS survey style.

#### Use job coordinates

Select the **Use job coordinates** check box if you want the selected NMEA messages to be generated by the Origin software so that they use the same coordinates and heights as the job.

Heights are output as antenna phase center (APC) heights.

**NOTE –** *If you are using an SP80 or SP85 receiver, NMEA output during a compensated point measurement remains antenna phase center (APC) heights. There is no tilt compensation applied to positions in the NMEA messages output in either receiver or job coordinates.*

Selecting the **Use job coordinates** check box limits the available NMEA message types to NMEA GGA, GPK, GLL and PJK messages. Clearing this check box makes more NMEA messages available for output.

Clear the **Use job coordinates** check box if you want the selected NMEA messages to be generated by the receiver so that they use the height reference available in the receiver. For orthometric

heights this means the geoid model built into the receiver firmware is used, not the one used by the job.

#### Messages to output

Select the message types to output, and the rate at which each message type is output.

#### Serial port settings

Make sure the serial port settings match those set in the device that is receiving the NMEA messages.

## To set up and connect the GNSS receiver

To set up and connect your surveying equipment when using a Spectra Geospatial integrated GNSS receiver:

1. Assemble and erect the equipment.

At the **rover**:

- a. Mount the receiver onto a range pole. Power for the receiver is supplied by the internal battery in the receiver.

**NOTE** – *In a postprocessed survey you may find it useful to use a bipod to hold the range pole while taking measurements.*

- b. Attach the controller to the holder.
- c. Connect the controller holder to the range pole.

At the **base**:

- a. Set the antenna over the ground mark using a tripod, a tribrach, and a tribrach adaptor.
- b. Use the tripod clip to hang the receiver on the tripod.

Alternatively, place the receiver in its base case. Run the antenna cable out of the portal in the side of the base case to the antenna so that the case can stay closed while the receiver is running.

- c. Assemble and erect the radio antenna.

2. Connect the controller and the receiver using the appropriate cable to Bluetooth. See [Bluetooth connections, page 433](#).
3. If you are using an **RTK radio survey**, connect the controller, receiver, radio and, if required, the power supply. See [To connect a radio to the GNSS receiver, page 367](#).
4. Turn on the receiver.

5. Turn on the controller.
6. If you are using an *RTK Internet survey*, connect the controller to the receiver using Bluetooth or a serial cable.

To connect the controller to the receiver using Bluetooth:

- a. Tap  and select **Settings / Connections**. Select the **Bluetooth** tab.
  - b. In the **Connect to GNSS rover** field, select the receiver.
  - c. Pair with the device.
7. On the controller, start Origin. If the Origin software does not automatically connect to the receiver, see [Auto-connect settings, page 437](#).

**TIP** – If you are using a modem in another device such as a mobile phone, turn on the device and connect it to the controller using Bluetooth or a serial cable before you connect the controller to the receiver.

### RTK radio data link

Use a radio data link if you are receiving RTK data from a radio at the base receiver over a radio channel.

### Radio considerations

Real-time survey methods rely on trouble-free radio transmission.

Sometimes the conditions or topography of a site adversely affect radio transmission, resulting in limited coverage.

To increase site coverage:

- Move the base stations to prominent points around the site.
- Erect the base radio antenna as high as possible.
- Use radio repeaters.

**TIP** – Double the height of the broadcast antenna to increase the coverage by approximately 40 %. To achieve the same effect, it would be necessary to quadruple the radio broadcast power.

### Radio repeaters

Radio repeaters increase the broadcast range of a base radio by receiving the base transmission and then rebroadcasting it on the same frequency.

You can use one repeater with a radio that has a 12.5 kHz channel spacing, and one or two repeaters with a radio that has a 25 kHz channel spacing.

You can configure the internal radio in a Spectra Geospatial GNSS receiver to repeat base data to other rovers while performing a rover survey. This is known as a roving repeater setup. The internal radio can repeat the base signal over its UHF communication link to other rovers while simultaneously performing a rover survey. This option is available in Spectra Geospatial GNSS receivers with internal radios that have the UHF Transmit option enabled. Select this repeater mode when you connect to the internal radio from the **Rover data link** screen in the survey style.

**NOTE** – *To use any of these radios as repeaters, they must be configured as repeaters. To do this, follow the steps above to connect to the radio and then choose a repeater mode, which appears if the radio you are connected to supports being a repeater. Alternatively, if the radio has a front panel, use that to set the repeater mode.*

### Software configuration

To configure a radio data link at the rover or the base, in Origin:

1. Connect the controller, receiver, radio and, if required, the power supply.
2. Configure the RTK survey style for a radio data link.

To start the survey, see [To start an RTK radio survey, page 378](#).

### To connect a radio to the GNSS receiver

When using radio in an RTK survey, you can connect the equipment using cables or Bluetooth.

For information on Bluetooth, see [Bluetooth connections, page 433](#).

To connect the equipment using cables:

1. If you are using a separate GNSS antenna, use the GNSS antenna cable to connect the GNSS antenna to the GNSS receiver port labeled **GPS**.

**NOTE** – *When inserting cables, align the red dot on the plug with the red line on the socket and then insert the plug carefully. Do not force plugs into the receiver ports.*

2. Connect the radio antenna to the radio using the cable attached to the antenna.
3. Connect the radio to the GNSS receiver port 3 using the appropriate cable.
4. For some third-party radios, a separate power supply is needed for the radio. If external power is required, connect the power supply with a 0-shell Lemo connection to port 2 or port 3 on the

receiver.

5. Connect the controller to the GNSS receiver port 1 using the 0-shell Lemo-to-Hirose cable.

To configure a radio data link



1. Connect the controller, receiver, radio and, if required, the power supply. See [To connect a radio to the GNSS receiver, page 367](#).
2. Tap  and select **Settings / Survey styles**. Select the required survey style. Tap **Edit**.
3. If you are setting up the data link for the:
  - rover receiver, select **Rover data link**.
  - base receiver, select **Base data link**.
4. Set the **Type** field to **Radio**.
5. Set the **Radio** field to the radio type you are using.  
If your radio does not appear on the list, select **Custom radio** and then define the receiver port, baud rate, and parity.
6. If the radio is connected:
  - directly to the receiver, clear the **Route through controller** check box. Specify the receiver port number that the radio is connected to, and the baud rate for communications.
  - to the controller, select the **Route through controller** check box. This enables real-time data between the receiver and the radio to pass through the controller. Specify the controller port number that the radio is connected to, and the baud rate for communications.



**NOTE –**

- To connect to and configure the internal settings of the radio you have selected, tap **Connect**.
- If the **Connect** softkey is not displayed, you cannot configure the internal settings for the type of radio you have selected.
- Some TRIMTALK and Pacific Crest radios must be in command mode before they can be configured. Command mode happens momentarily at power up. Follow the prompts to connect to the radio.
- To add a new receive frequency for the rover radio, tap **Add Frq**. Enter the new frequency and tap **Add**. The new frequency is sent to the radio and appears in the list of available frequencies. To use the new frequency, you must select the frequency from the list.

7. If the details are correct, tap **Enter**.

A radio signals icon  appears in the status bar when a survey is started. If there is a problem with the data link between the base and rover receivers, a red cross is drawn over the radio signals icon .

Tap on the radio signals icon to check the settings. If the controller is connected to a receiver with an internal radio you can also reconfigure the radio's internal settings.

**TIP –** You can also access the data link configuration by tapping the **Data link** button in the **GNSS functions** screen. See [GNSS functions, page 400](#).

**NOTE –** In some countries it is illegal to change the frequency of a radio. The Origin software uses the latest GNSS position to see if you are in one of these countries. If you are, only the available frequencies are displayed in the **Frequency** field.

If you select **Base data link** and set the **Type** field to **Custom radio**, you can also enable **Clear To Send (CTS)**.



**WARNING –** Do not enable CTS unless the receiver is connected to a radio that supports CTS. Spectra Geospatial GNSS receivers support RTS/CTS flow control when you enable CTS. For more information on CTS support, refer to the documentation supplied with your receiver.

---

**NOTE** – The internal radio in a Spectra Geospatial integrated GNSS receiver can also operate as a base radio if it is configured as a transceiver, and if the UHF Transmit option is on in the receiver. This avoids having to use an external radio solution at the base receiver to broadcast base data.

### RTK Internet data link

Use an Internet data link if you are obtaining RTK data by connecting to a server using an IP address. The equipment at the rover connects to the server hosting the data from the base receiver using an IP address. RTK data is transferred over the Internet.

Your controller and your receiver may each have an internal modem. You may also have another device that contains a modem, such as a mobile phone. The modem you use for the connection to the server determines how you will connect and configure your equipment.

### Rover equipment setup considerations

How you will connect the Origin software to the Internet depends on:

- Which device contains the SIM card you want to use for the data.
- Whether you want to use the Internet only to receive RTK corrections, or whether you will use it for additional functions such as downloading projects and jobs or email.

You can use the Internet for additional functions if you:

- Connect the controller to the Internet using a Wi-Fi or cellular connection.
- Connect the controller to the Internet through another device, such as an older receiver or mobile phone that supports the Bluetooth DUN service. You can also connect the controller to the Internet through a separate smartphone.

You cannot use the Internet for additional functions if you connect the receiver to the Internet.

For more information, see [To create a GNSS contact for a rover Internet data link, page 371](#).

### Software configuration

To configure an Internet data link at the rover or the base, in Origin:



1. Configure a connection to the Internet. See [Internet connection setup, page 439](#).
2. Configure the RTK survey style for an Internet data link and select the appropriate GNSS contact. See [To configure an Internet data link, page 371](#).

3. Create a GNSS contact that specifies:
  - a. How the Origin software will connect to the Internet.
  - b. Where the Origin software will obtain RTK corrections from.
  - c. The connection settings for the real-time correction source.

See [To create a GNSS contact for a rover Internet data link, page 371](#).

To start the survey, see [To start an RTK Internet survey, page 378](#).

To configure an Internet data link

1. Configure a connection to the Internet. See [Internet connection setup, page 439](#).
2. Tap  and select **Settings / Survey styles**. Select the required survey style. Tap **Edit**.
3. Select **Rover data link**.
4. Set the **Type** field to **Internet connection**.
5. In the **GNSS contact** field:
  - If you have already configured the GNSS contact to use for the dial-in data link, enter the GNSS contact name for the contact, or tap  to select the GNSS contact from the **GNSS Contacts** list. The list is filtered according to the contact type.
  - To create a new GNSS contact, tap  to open the **GNSS Contacts** screen and then tap **New**.
6. **TIP** – To display the GNSS contact that is configured in the survey style, or to be able to change the GNSS contact when you start the survey, select the **Prompt for GNSS contact** check box.
7. Tap **Accept**.

To create a GNSS contact for a rover Internet data link

When creating a GNSS contact for an RTK Internet data link, the **Edit GNSS contact** screen provides the following tabs:

- Use the **Network connection** tab to select how you want to connect to the Internet.
- Use the **Corrections** tab to select where you want to obtain RTK corrections from and to configure connection settings for the selected correction source.

### To create the GNSS contact

1. Tap  and select **Settings / Connections**. Select the **GNSS contacts** tab.
2. Tap **New**. The **Edit GNSS contact** screen appears.
3. Enter the **GNSS contact name**.
4. Set the **Contact type** to **Internet rover**.
5. Configure the **Network connection** settings for the GNSS contact as required. See [To configure how to connect to the Internet, page 372](#) below.
6. Configure the **Corrections** settings for the GNSS contact as required. See [To configure correction settings, page 373](#) below
7. Tap **Store**.

### To configure how to connect to the Internet

Use the **Network connection** tab in the **Edit GNSS contact** screen to select how you want to connect to the Internet.

**NOTE** – *If the controller is an Android device, the only network connection option is to use the SIM card in the controller. The connection named **Controller Internet** is selected by default in the **Network connection** field.*

### To connect the controller to the Internet

When you connect to the Internet using the controller, the **Controller Internet** connection is available for other functions during the RTK survey, not just receiving RTK data. Other functions include downloading projects and jobs or sending email.

When using a **Controller Internet** connection, you can connect the controller to the receiver using Bluetooth or a serial cable.

To configure the network connection:

1. In the **Network connection** field:
  - a. Tap  to open the **Network connection** screen and select the connection named **Controller Internet**.
  - b. If you have not yet configured the **Controller Internet** connection, tap **Configure** in the **Network connection** screen to open the operating system connection settings screen and

set up the connection.

- c. In the **Network connection** screen tap **Accept** to return to the **Edit GNSS contact** screen.

## 2. Tap **Store**.

To connect the controller to the Internet through another device

If you have another device such as an older receiver or a mobile phone that supports the Bluetooth DUN service, you can connect the controller to the Internet through that device. You can also connect the controller to the Internet through a separate smartphone.

The Internet connection is available for other functions during the RTK survey, not just receiving RTK data. Other functions include downloading projects and jobs or sending email.

**NOTE** – To connect to the Internet through a receiver or a mobile phone that is not a smartphone:

- The modem in the device must support the Bluetooth DUN service.
- The receiver must be an SP85 receiver.

If your receiver does not support Bluetooth DUN and you want to be able to use the Internet on the controller, you must [use a Controller Internet connection](#).

To connect the controller to the Internet using:

- a connected smartphone, see [Internet setup using a separate smartphone, page 441](#).
- an older receiver or mobile phone, see [Internet connection using another device, page 443](#).

To configure correction settings

Use the **Corrections** tab in the **Edit GNSS contact** screen to select where you want to obtain RTK corrections from and to configure connection settings for the selected correction source.

To use the Trimble CenterPoint RTX correction service

1. Set the **Use RTX (Internet)** switch to **Yes**.
2. In the **Mountpoint name** field, select the mountpoint appropriate for your RTX subscription and region. The **RTXIP** mountpoint is for global RTX corrections, while others are particular to specific network coverage areas.
3. If required, set the **Use proxy server** switch to **Yes** and then enter the proxy server address in the **Proxy server** field and enter the **Proxy server port**.

4. Tap **Store**.

To use corrections from an NTRIP server

1. Set the **Use RTX (Internet)** switch to **No**.
2. Set the **Use NTRIP** switch to **Yes**.
3. To force the Origin software to always use NTRIP version 1.0, select the **Use NTRIP v1.0** check box.
4. If the NTRIP server:
  - uses a proxy server, set the **Use proxy server** switch to **Yes** and then enter the proxy server address in the **Proxy server** field and enter the **Proxy server port**.
  - does not use a proxy server, set the **Use proxy server** switch to **No**.
5. To connect to a mountpoint on starting a survey without being prompted for the mountpoint name, set the **Connect directly to Mountpoint** switch to **Yes** and then enter the **Mountpoint name**.

**TIP** – If a mountpoint name is not specified, the system will prompt you when you start a survey. Your selection will then be stored in GNSS contacts. If the specified mountpoint cannot be accessed when you start the survey, a list with available mountpoints appears.
6. If a user name and password are required to use NTRIP server, enter the details in the **NTRIP username** and **NTRIP password** fields.
7. In the **IP Address** and **IP port** fields, enter the information for the NTRIP server that were sent to you from the data provider.
8. If the rover must supply identification information through regular NMEA messages to the base data server, select the **Send user identity info** check box. At the start of the survey, the software asks you to enter this information.
9. Tap **Store**.

For more information, see [NTRIP server settings, page 375](#).

#### To use corrections from a broadcast server

1. Set the **Use RTX (Internet)** switch to **No**.
2. Set the **Use NTRIP** switch to **No**.
3. In the **IP Address** and **IP port** fields, enter the information for the broadcast server that were sent to you from the data provider.
4. If the rover must supply identification information through regular NMEA messages to the base data server, select the **Send user identity info** check box. At the start of the survey, the software asks you to enter this information.
5. Tap **Store**.

#### To use corrections from a controller connected to the base receiver

1. Set the **Use RTX (Internet)** switch to **No**.
2. Set the **Use NTRIP** switch to **No**.
3. In the **IP Address** and **IP port** fields, enter the information displayed in the **IP Settings of this base** field in the **Base** screen displayed on the controller at the base.

***NOTE** – If the IP address of the base controller appears to be invalid, Spectra Geospatial recommends that you perform a soft reset of the device before you connect to the Internet and start the base.*

4. If the rover must supply identification information through regular NMEA messages to the base data server, select the **Send user identity info** check box. At the start of the survey, the software asks you to enter this information.
5. Tap **Store**.

#### NTRIP server settings

An NTRIP server is a broadcast Internet server that manages authentication and password control for differential correction sources such as VRS networks, and relays corrections from the source that you select.

NTRIP is the acronym for Networked Transport of RTCM via Internet Protocol.

Configure NTRIP settings when you create the **GNSS contact** for the Internet data link. When you start the survey, a connection is established to the NTRIP server. In addition, a table appears

showing the available sources of corrections from the server, referred to as "mountpoints". These can be single station sources, or network sources (for example, VRS). The type of base station data provided by each mountpoint is shown in the source table. To determine the closest source, tap the **Distance from here** heading to sort that column. The base data from the selected mountpoint streams through Origin to the connected GNSS receiver.

If authentication is required to connect to a particular mount point, and this was not configured in GNSS contacts, the Origin software displays a screen where you can enter your username and password.

### NTRIP protocol versions

When the Origin software connects to the NTRIP server, it checks if the server supports NTRIP version 2.0, and if it does then the software communicates using version 2.0 protocols. If it does not, then Origin communicates using NTRIP version 1.0 protocols.

To force the software to always use NTRIP version 1.0, select the **Use NTRIP v1.0** check box when you configure the NTRIP settings in the GNSS contact.

NTRIP version 2 includes improvements to the original standard. Origin supports the following NTRIP version 2 features:

NTRIP 2.0 feature	Advantages over 1.0
Full HTTP compatibility	Addresses proxy server issues. Supports virtual hosts using the "Host directive".
Chunked transfer encoding	Reduces data processing time. More robust data checking.

## To start and end the GNSS survey

The steps for starting the GNSS survey depend on the type of GNSS survey you are starting and whether the receiver is in base mode or receiver mode.

**NOTE** - *If you start a survey while the receiver is logging data, logging stops. If you start a survey that specifies data logging, logging restarts to a different file.*

### To start a base survey



**CAUTION** - If you are using a radio to transmit base data to the rover, make sure that the radio antenna is connected to the radio before you connect it to the receiver and start the base survey. If it is not, the radio will be damaged.



1. Tap  and select **Measure** and select the required survey style from the list.
2. From the **Measure** menu, tap **Start base receiver**.
  - If the controller is connected to a receiver that was logging data, the data logging stops.

**NOTE -**

- *When using Spectra Geospatial GNSS receivers that do not have the UHF Transmit option, use an external radio at the base even if you use the internal radio at the rover.*
- *You can use a Custom radio if the radio you have is not listed.*

The **Start base** screen appears.

**NOTE -** *When you start a survey, the Origin software automatically negotiates the highest possible baud rate for communicating with the connected receiver.*

3. Tap **Start**.

The base receiver starts to record data and transmit corrections in the format selected in the Survey Style.

If you are carrying out a real-time survey, a message confirms the base receiver has started.

**NOTE -** *For a real-time survey, check that the radio is working before leaving the equipment. The data light should be flashing.*

Disconnect the controller from the base receiver but **do not** turn off the receiver. You can now set up the rover receiver.

### To start an RTK rover survey

1. [Set up and connect the GNSS receiver.](#)
2. If you are receiving corrections from a single base station, start the base receiver.
3. In Origin, make sure the required job is open.
4. To start the survey, tap  and select **Measure** or **Stakeout**. If there is more than one survey style configured, select a survey style from the list. Select the software function to use, for example **Measure points**.

When you select a survey style for the first time, the software prompts you to customize the style for your specific hardware.

5. If you have selected any "Prompt for" settings in the RTK survey style, you are prompted to confirm the correction source. Tap **Accept**.
6. Use the status bar to confirm the software is connected and receiving correction data.

If base corrections are being received and there are sufficient satellites, the survey initializes automatically using the on the fly initialization method.

7. Measure or stake out points.

#### To start an RTK radio survey

To start a survey using VRS or FKP (RTCM), you must send an approximate position for the rover receiver to the control station. When you start the survey, this position is automatically sent through your radio communications link in a standard NMEA position message. It is used to compute the RTK corrections your receiver will use.

1. [Set up and connect the GNSS receiver.](#)
2. In Origin, make sure the required job is open.
3. To start the survey, tap  $\equiv$  and select **Measure** or **Stakeout**. If there is more than one survey style configured, select a survey style from the list. Select the software function to use, for example **Measure points**.

When you select a survey style for the first time, the software prompts you to customize the style for your specific hardware.

4. Use the status bar to confirm the software is connected and receiving correction data.

If base corrections are being received and there are sufficient satellites, the survey initializes automatically using the on the fly initialization method.

5. Measure or stake out points.

#### To start an RTK Internet survey

1. [Set up and connect the GNSS receiver.](#)
2. If you are receiving corrections from a single base station, start the base receiver.

3. In Origin, make sure the required job is open.
4. To start the survey, tap  and select **Measure** or **Stakeout**. If there is more than one survey style configured, select a survey style from the list. Select the software function to use, for example **Measure points**.

When you select a survey style for the first time, the software prompts you to customize the style for your specific hardware.

If you are using the modem in the controller to connect to the Internet and it is:

- already connected, the controller uses the existing Internet connection for the base data.
- not yet connected, the controller opens an Internet connection using the connection specified in the survey style.

5. If the **Prompt for GNSS contact** check box is selected in your survey style, you are prompted to select the GNSS contact to use.
6. If **Connect directly to Mountpoint** or the **NTRIP Mountpoint** name was not configured in the GNSS contact, or the defined mountpoint cannot be accessed, you are prompted to select the mountpoint you want to receive corrections from.

The message **Establishing network connection** appears. The software connects to the mountpoint and then begins the survey. Once the corrections data link is established, the network connection icon  appears on the status bar.

**NOTE** - *If you are using the internal modem of an SP80 receiver and the first connection attempt fails, you may need to wait up to a minute for the modem to power up and initialize before you attempt the connection again.*

If base corrections are being received and there are sufficient satellites, the survey initializes automatically using the on the fly initialization method.

7. Measure or stake out points.

#### Receiving RTK data on demand

If you are using an Internet connection to send RTK data from the base to the rover, then you can use the **RTK on demand** functionality to control the amount of data broadcast from the base

receiver. You can request the base station to send data only when you require it. This will reduce the amount of data received by your cellular phone and may reduce costs from your cellular network service provider.

The RTK on demand function requires an Internet connection at both the GNSS base station and the rover. The Origin software must be at both the GNSS base station and the rover, or you must be connected to the Trimble VRS Now subscription service.

Once the RTK survey is running over an Internet connection, you can access the **RTK on demand** controls by tapping the  icon in the status bar.

When the survey is started, the Origin software will default to Play  mode. When in Play mode, RTK data will be streamed continuously.

If you tap the  softkey, your survey will go into Pause mode and data will only be streamed when required. The Origin software requests data from the base station when initialization is lost, or when you choose to measure a point, or when you start continuous topo, or when you use the stakeout functionality. As soon as the receiver has regained initialization, or the survey task is complete, then the Origin software requests the base station to stop streaming data.

**NOTE** – *When in Pause mode, you cannot measure rapid points or fast fix points.*

If you tap the  softkey then your survey will go into Stop mode and no RTK data will be streamed. This can be used in situations where you do not wish to end your survey, but do not require the receiver to stay initialized until you are ready to start surveying again.

#### To disconnect and reconnect to the Internet

If you lose the connection to the Internet or network when using an Internet data link, tap the network connection icon  in the status bar.

The **Rover data link** screen appears.

If the internet connection is established using the controller's internal modem, tap **Connect** in the **Rover data link** screen. The operating system **Networks** tab opens from the system tray. Use the **Networks** tab to re-establish the network connection, and when that connection is re-established Origin will automatically reconnect to the base.

If the Internet or network remains connected, but the link to the base data server is disconnected, tap **Retry** in the "Base station data connection closed unexpectedly" message. Origin will then attempt to reconnect to the base data server. Alternatively, if you wish to reconnect at a later time, tap **OK** in the "Base station data connection closed unexpectedly" message. When you want to reconnect, tap **Connect** in the **Rover data link** screen.

If the internet connection is established using an external modem, such as the receiver's internal modem, tap **Redial** to have the external modem re-establish its Internet connection. When that connection is established, Origin will automatically reconnect to the base.

When using an external modem, to end the connection at any time, tap **Hang up**. Continue the survey and then reconnect to the internet when required. A mobile Internet connection can be hung up in the **Rover data link** screen only when the connection was established when you started the survey. However, you can always redial the connection from within the **Rover data link** screen while the survey is running.

#### To manually connect to the GNSS contact

When you start an RTK survey that uses an Internet data link, the Origin software automatically connects to the real-time correction source using the GNSS contact configured in the survey style.

**NOTE** – *If you start a survey that uses an Internet data link after you have already manually connected to the **GNSS contact**, then the Origin software uses the already established connection for the survey.*

If you experience issues connecting to the real-time correction source, you can manually connect to the GNSS contact to check if there are any issues.

#### To connect to the GNSS contact at any time

1. Tap  and select **Settings / Connections**. Select the **GNSS contacts** tab.
2. Select the GNSS contact. It must be configured for an Internet connection. See [Internet connection setup](#).

**NOTE** – *If you are using the receiver's Internal modem for the Internet connection and you are connected to the receiver through Bluetooth wireless technology, you must select the receiver in the **Bluetooth modem** field of the **Edit GNSS contacts** form.*

3. Tap **Connect** below the **GNSS contacts** list.

An Internet connection is established and a check mark appears next to the contact to show that it is in use.

4. To end the Internet connection, select the GNSS contact and then tap **Hang up**.

#### To run a test report on the GNSS contact

When there are connection problems or if the GNSS contacts contains incorrect settings, use the **Test** softkey to troubleshoot.

**NOTE** – *Only mobile Internet GNSS contacts can be tested.*

1. Tap  and select **Settings / Connections**. Select the **GNSS contacts** tab.
2. Select the GNSS contact entry that you want to test.
3. Tap **Edit** and then tap **Test**.
4. The Origin software tests the settings defined in the **GNSS contacts** file to make sure that they are correct. If the test fails, a report is generated detailing the problem and suggesting a solution.

### RTK initialization

When you start an RTK survey, if base corrections are being received and there are sufficient satellites, the survey initializes automatically using the on the fly initialization method. A survey must be initialized before centimeter-level surveying can begin.

After initialization, the survey mode changes from **Not initialized** to **Initialized**. The mode remains **Initialized** if the receiver continuously tracks the minimum number of satellites. If the mode changes to **Not initialized**, you must reinitialize the survey.

**NOTE** – *Initialization reliability depends on the initialization method used and whether multipath occurred during the initialization phase. Multipath occurs when GNSS signals are reflected off objects, such as the ground, a building, or trees. When initializing, always choose a site that has a clear view of the sky and is free of obstructions that could cause multipath. The initialization process in Spectra Geospatial receivers is very reliable, but to reduce the effects of multipath, use good survey practice and periodically check your initialization by measuring previously measured points with a new initialization. To reduce the effects of multipath during an on-the-fly initialization, move around.*

### To reinitialize an RTK survey while roving

1. In the **RTK Initialization** screen select one of the following from the **Method** field:
  - **Reset RTK**
  - **Reset SV tracking** to drop all satellite tracking, reacquire satellites and reinitialize the RTK survey

**NOTE** – *Resetting SV tracking in compromised GNSS environments is not recommended.*

2. Tap **Reset** or **Start**.

### To initialize RTK on independent subsets of satellites

You can initialize an RTK survey using independent subsets of tracked satellites. For more information, see [To use independent subsets of satellites tracked in RTK surveys, page 404](#).

In the **RTK Initialization** screen:

- To initialize on the first independent subset of satellites, select **Reset – track SV set A** from the **Method** field and tap **Reset**.
- To initialize on the second independent subset of satellites, select **Reset – track SV set B** from the **Method** field and tap **Reset**.
- To initialize on all available satellites, select **Reset – track all SVs** from the **Method** field and tap **Reset**.

**TIP** – The **Reset RTK** and **Reset SV tracking** menu items operate on the currently selected SV tracking subset.

### Required satellites for RTK initialization

The number of satellites required depends on whether you are using satellites from only one constellation or a combination of constellations. After initialization, a position can be determined and the initialization can be maintained with one satellite less than the number required to initialize. If the number of satellites drops below this number, the survey must be reinitialized.

The minimum L1/L2 satellites required are:

Satellite systems	Required satellites for initialization	Required satellites to produce positions
GPS only	5 GPS	4 GPS
GPS + QZSS	4 GPS + 1 QZSS	3 GPS + 1 QZSS
GPS + GLONASS	4 GPS + 2 GLONASS	3 GPS + 2 GLONASS
GPS + BeiDou	4 GPS + 2 BeiDou	3 GPS + 2 BeiDou
GPS + Galileo	4 GPS + 2 Galileo	3 GPS + 2 Galileo
BeiDou only	5 BeiDou	4 BeiDou
BeiDou + GPS	4 BeiDou + 2 GPS	3 BeiDou + 2 GPS
BeiDou + GLONASS	4 BeiDou + 2 GLONASS	3 BeiDou + 2 GLONASS
GLONASS only	-	-

Galileo only

-

-

**NOTE** – You cannot initialize if the PDOP is greater than 7.

To initialize on a known point

1. Position the rover antenna over the known point.

In a postprocessed survey you can initialize on:

- a point measured previously in the current job
- a point that you will provide coordinates for later (before the data is postprocessed)

2. Tap  and select **Measure** and then select **PPK initialization**.
3. In the **Method** field, select **Known Point**.
4. In the **Point name** field, select the known point from the list of points in the job.
5. Enter values in the **Antenna height** field, and make sure that the setting in the **Measured to** field is correct.
6. When the antenna is centered and vertical over the point, tap **Start**.

The controller starts to record data, and the static icon  appears in the status bar. Keep the antenna vertical and stationary while data is recorded.

**TIP** – If you are using a GNSS receiver with a built-in tilt sensor, tap **eBubble** (or press **Ctrl + L**) to display the eBubble. When the bubble is green, tap **Start** to ensure that the point is measured within the predefined tilt tolerance. The tolerance is that specified for a topo point.

A message confirms when the receiver is initialized, together with the deltas from the current position to the known point.

7. Tap **Accept**.



If the initialization fails, the results are displayed. Tap **Retry** to retry the initialization.

To start an RTX survey

1. Start the survey using the RTK survey style you configured for RTX. See [Configuring an RTX survey, page 352](#).



When data from the RTX correction service is being received via:

- RTX (SV signals), the radio icon  changes to an RTX icon , and RTX appears on the status line.
- an Internet connection, the network connection icon  appears.

2. Wait for convergence.

Convergence can take up to 30 minutes in typical conditions.

When the message **Convergence has been gained** appears, you can begin surveying

**TIP** – To view the **RTX status** screen, in an RTX (SV) survey, tap . In an RTX (Internet) survey, tap **RTX status** in the Instrument menu.

3. Measure or stake out points.

**NOTE** –

- *Although the RTX rover solution may have converged, it may not yet meet the precision tolerances for point measurement. You may need to remain at a point longer to meet the precision tolerances specified, as the RTX rover solution should converge more when the rover is in static mode. Precisions for surveys using the Trimble Centerpoint RTX service are very sensitive to environmental conditions such as multipath, ionosphere scintillation, and particularly tropospheric conditions and tree canopy.*
- *To change the precision level at which convergence is acceptable, clear the **Auto tolerance** check box in the **Rover options** screen and enter the values that you want to use.*

To compute an RTX-RTK offset



**WARNING** – Take great care to avoid changing the offset already in a job to a less precise offset, as this action may cause the precision of the points stored in the job to no longer meet the precision tolerances applied when the points were measured. See [RTX-RTK offsets, page 353](#).

---

1. Tap  and select **Measure**. Tap **RTX-RTK offset**.
2. In the **RTK point** field, select a point. This must be a point measured using RTK.

3. In the **RTX point** field, select or measure an RTX point. This must be a point measured using the CenterPoint RTX correction service.

The offset is computed immediately when the two point fields are completed.

4. Review the results of the offset computation. If acceptable, tap **Store** to commit the offset to the job.

**NOTE** – The precision of the offset and therefore the precision of the RTX points reduced into the RTK reference frame depends on the precision of the measured RTK and RTX points used to compute that offset. You **must** use the most precise point measurements possible to compute the offset.

To remove an RTX-RTK offset, view the offset in the **RTX-RTK offset** screen and then tap **None**. Tap **Yes** to confirm. The value of the offset is changed to zero.

#### To view RTX status

To view the **RTX status** screen, in an RTX (SV) survey, tap . In an RTX (Internet) survey, tap **RTX status** in the Instrument menu.

The **RTX status** screen shows the current **Correction satellite name**. To select a different satellite, tap **Options** and then select the required satellite from the list. You can change the correction satellite at any time; changing the correction satellite does not require restarting the survey. Alternatively, select **Custom** and then enter the frequency and bit rate to use. Changes you make to the settings are used the next time you start a survey.

In an RTX survey, the **Reset** button on the satellite plot/list screen resets SV tracking as well as RTX convergence. The **Reset** button on the **RTX status** screen resets the RTX convergence but not the satellite tracking.

#### To switch to postprocessed infill

During periods when no base corrections are received, the **Radio link down** message flashes in the status line.

To continue surveying, tap  and select **Measure** and then select **Start PP infill**. When postprocessing infill starts, raw data is logged at the rover. For successful baseline resolution, you must use postprocessed kinematic observation techniques.

**NOTE** – Initialization cannot be transferred between the RTK survey and the PP infill survey. Initialize the PP infill survey like any other postprocessed kinematic survey. In a postprocessed survey, only rely on the On the fly (automatic) initialization if you are certain that the receiver will observe at least 5 satellites without interruption for the next 15 minutes, or 6 satellites without interruption for the next 8 minutes.

When base corrections are received again, the **Radio link up** message appears in the status line. This message also shows the initialization mode of the RTK survey.

To stop data logging at the rover, tap  and select **Measure** and then select **Stop PP infill**. Real-time measurements are resumed.

To start a postprocessed rover survey

1. [Set up and connect the GNSS receiver](#).
2. In Origin, make sure the required job is open.
3. To start the survey, tap  and select **Measure**. If there is more than one survey style configured, select a survey style from the list. Select the software function to use, for example **Measure points**.

When you select a survey style for the first time, the software prompts you to customize the style for your specific hardware.

4. If you have selected any "Prompt for" settings in the RTK survey style, you are prompted to confirm the correction source. Tap **Accept**.
5. Use the status bar to confirm the software is connected and receiving correction data.

In a FastStatic survey you can begin surveying immediately.

To achieve centimeter-level precisions from a PP kinematic survey when the data is processed, the survey must initialize. With dual-frequency receivers, the initialization process begins automatically if at least five L1/L2 satellites are being observed. See [PP initialization times, page 354](#).

**NOTE** – In a postprocessed survey, only rely on the *On the fly (automatic) initialization* if you are certain that the receiver will observe at least 5 satellites without interruption for the next 15 minutes, or 6 satellites without interruption for the next 8 minutes. Otherwise, [initialize on a known point](#).

If you do **not** require centimeter-level results and want to start surveying immediately, select **Measure / PPK initialization**. Tap **Init** and set the **Method** field to **No initialization**.

6. Measure points.

**NOTE** – You cannot stake out points during a postprocessed survey.

## GNSS survey status

When the controller is connected to a receiver, the status line displays the current GNSS survey mode:

### **No Survey**

The receiver is connected but a survey has not been started.

### **RTK:Fixed**

The current RTK survey is initialized, and the solution type is L1 fixed-centimeter-level.

### **RTK:Float**

The current RTK survey is not initialized, and the solution type is L1 float.

### **RTK:Check**

The current RTK survey is verifying the initialization.

### **RTK:Auton**

The radio link is down in the current RTK survey, and the solution is an autonomous position.

### **RTK:SBAS**

The radio link is down in the current RTK survey, and the solution is an SBAS position.

### **RTX**

The current survey type is RTX.

### **SBAS**

The current survey type is differential, and using signals from an SBAS.

### **FastStatic**

The current survey type is FastStatic.

### **PPK:Initialized**

The current postprocessed kinematic survey is initialized. When postprocessed, it should yield a centimeter-level solution.

### **PPK:Not initialized**

The current postprocessed kinematic survey is not initialized. When postprocessed, it may not yield a centimeter-level solution.

### **Infill:Initialized**

The current postprocessed kinematic infill survey is initialized. When postprocessed, it should yield a centimeter-level solution.

### **Infill:Not initialized**

The current postprocessed kinematic infill survey is not initialized. When postprocessed, it may not yield a centimeter-level solution.

### Infill

The current survey type is differential, and you are doing an infill session.

If the controller is connected to a receiver equipped with HD-GNSS technology:

✓ in the status line indicates the precision tolerances have been met.

✗ in the status line indicates the precision tolerances have not been met

### GNSS survey error messages

The following messages indicate a problem during a GNSS survey or when you attempt to start one.

#### Error: Outside usage region

If this message appears when starting a survey, the connected receiver is unable to be used in the current geographic location. For more information, contact your Spectra Geospatial distributor.

#### Receiver supports Location RTK precisions, set style tolerances accordingly

If this message appears when starting an RTK survey, the connected receiver supports Location RTK, which limits the precision of the RTK solution in the receiver. Tap **Yes** to change the survey style precision settings to match the Location RTK precision limit of the receiver. If the survey style is already set to a higher precision than the Location RTK precision limit of the receiver, then the survey style is not updated.

When the receiver has Location RTK enabled, the status line shows RTK: Float. You cannot store fixed positions when Location RTK is enabled in the receiver.

Tap **No** to keep the current survey style precision settings.

#### Cannot start streamed corrections

If this message appears during an RTK survey, make sure that the Internet connection you are using works outside of the Origin software. Connect to the Internet and make sure you can connect to a website such as [www.google.com](http://www.google.com). Leave that connection open and start a survey in the Origin software. If the survey still fails to start correctly, there may be a problem with the IP address or port number in the style, or the base station providing the data may not be operational.

#### No Base Data

If you start an RTK survey and the **No base data** message appears, check the broadcast format, the initialization string for your modem, the IP address, and the port number of the base.

#### Warning: Base coordinates different. Coordinates of base point <Point name> in job differ from received coordinates

If this message appears when receiving RTK corrections, it means that the point name of the base received from the base data link is the same as a point name already in the job file, and the two

points have different coordinates. If you are certain that the base is set up on the same point as the one already in the job database, then tap **Job** to use the job database coordinates for the point. If the base is in a different location to the point already in the job database, then you must change the point name. Tap **Received** to use the coordinates received from the data link and rename the new base point. Tap **Cancel** to cancel the survey.

**NOTE** – *If you have an RTX-RTK offset in the job, you will not be given the choice of using the received coordinates for the base. Correct use of the offset relies on all RTK being in the same terms, and if the point with different coordinates to those already in the job comes from the base this could mean the RTK is not in the same terms.*

### To end the survey

When you have measured or staked out all points required, do the following:

1. Tap  and select **Measure** or **Stakeout** and then tap **End GNSS survey**.

If the Origin software is connected to a modem at the base station for the survey, the modem is automatically disconnected.

**NOTE** – *If you started the survey with the controller already connected to the Internet, the connection does not close when you end the survey. You must manually end the connection.*

2. When prompted to power down the receiver, tap **Yes**.
3. Turn off the controller **before** disconnecting the equipment.
4. If you set up your own base station for the survey:
  - a. Return to the base station.
  - b. If required, reconnect the controller to the base receiver.
  - c. Tap  and select **Measure** or **Stakeout** and then tap **End GNSS base survey**.
  - d. If the controller was logging base data, in the **Base** screen tap **End**.

### Site calibration

Calibration is the process of adjusting projected (grid) coordinates to fit the local control. A calibration calculates parameters for transforming Global coordinates into local grid coordinates (NEE).

You should calculate and apply a calibration before:

- staking out points
- computing offset or intersection points

If you calibrate a project and then survey in real time, the General Survey software gives real-time solutions in terms of the local coordinate system and control points.

#### Local control for calibration

Spectra Geospatial recommends that you observe and use **a minimum of four local control points** for the calibration calculation. The maximum number of points you can have in a calibration is 200. For best results, local control points should be evenly distributed over the job area as well as extending beyond the perimeter of the site (assuming that the control is free of errors).

**TIP** – Apply the same principles as you would when placing control for photogrammetric jobs. Make sure that the local control points are evenly distributed to the extent of the job area.

#### Reusing a calibration

You can reuse the calibration from a previous job if the new job is completely encompassed by the initial calibration. If a portion of the new job lies outside the initial project area, introduce additional control points to cover the unknown area. Survey these new points and compute a new calibration, and then use this as the calibration for the job.

To copy the calibration from an existing job to a new job, select the existing job as the current job and then create a new job and in the **Template** field select **Last used job**. Alternatively, use the **Copy between jobs** function to copy the calibration from one job to another.

#### Software calibration calculations

Use Origin to perform a calibration using a least squares computation and calculate either a [horizontal](#) and [vertical](#) adjustment, or a Transverse Mercator projection and a 3-parameter datum transformation, depending on what the coordinate system settings that have already been defined in the job. Each method results in the computation of different components, but the overall result is the same if enough reliable control points (coordinates in your local system) are used. The two methods are:

- If you used published datum transformation parameters and map projection details when you created a job, and if you provide enough control points during the calibration, then during calibration the software calculates horizontal and vertical adjustments. Horizontal control points allow scale error anomalies in the map projection to be removed. Vertical control allows local ellipsoid heights to be transformed into useful orthometric heights.

**TIP** – Always use published parameters if they exist.

- If you did not know the map projection and datum transformation parameters when you created the job and so you selected **No projection / no datum** and if you specified that ground coordinates were required, then during calibration the software calculates a Transverse Mercator projection and a Molodensky three-parameter datum transformation using the supplied control points. The project height you specified when creating the job is used to compute a ground scale factor for the projection so that ground coordinates are computed at that height.

The following table shows the output of a calibration when various data is supplied.

Projection	Datum transformation	Calibration output
Yes	Yes	Horizontal and vertical adjustment
Yes	No	Datum transformation, horizontal and vertical adjustment
No	Yes	Transverse Mercator projection, horizontal and vertical adjustment
No	No	Transverse Mercator projection, zero datum transformation, horizontal and vertical adjustment

The following diagram shows the order of calculations performed when a calibration is calculated.



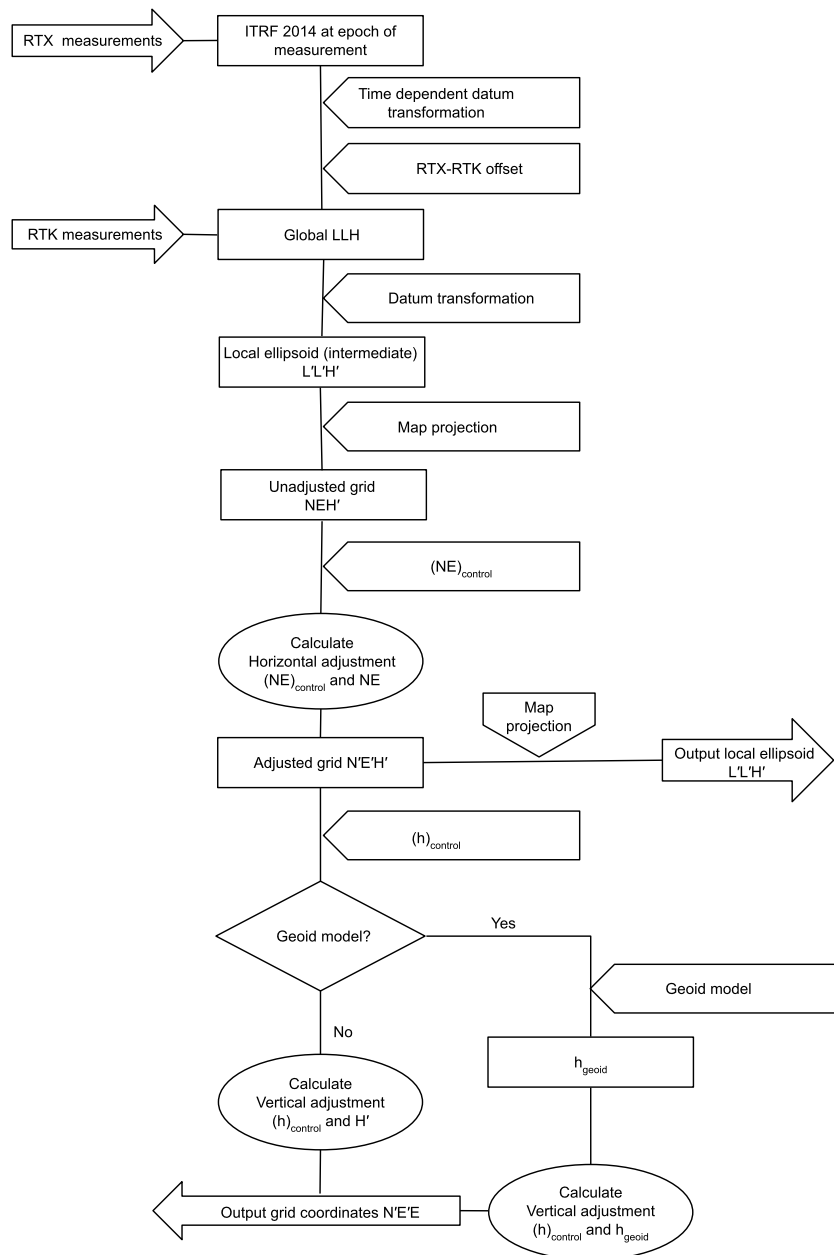

### To calibrate point coordinates

1. Enter the grid coordinates of your control points. Key these in, transfer them from your office computer, or measure them using a conventional total station.

Be careful when naming points that are to be used in a calibration. Before you begin, familiarize yourself with the [Database search rules](#).

2. Place the calibration points around the perimeter of the site. Do not survey outside of the area enclosed by the calibration points, as the calibration is not valid beyond this perimeter.
3. Measure the points with GNSS.

You can use up to 200 points for a calibration. Spectra Geospatial strongly recommends that you use a minimum of four 3D points in local grid coordinates (N, E, E) and four observed GNSS points in **Global** coordinates. This should provide enough redundancy. If you do not specify the coordinate system, the Origin software calculates a Transverse Mercator projection and a three-parameter datum transformation.

You can use a combination of 1D, 2D, and 3D local grid coordinates. If no projection and no datum transformation are defined, you must have at least one 2D grid point.

4. Perform an [automatic](#) or a [manual](#) calibration.

If all the points have been measured, you do not need to connect the controller to a receiver during a manual calibration.

Multiple calibrations can be performed in one job. The last calibration performed and applied is used to convert the coordinates of all previously surveyed points in the database.

5. To obtain the current list of points being used in the calibration, select **Measure / Site calibration**.

#### Notes and recommendations

- The set of **Global** coordinates must be independent of the set of grid coordinates.
- You select the grid coordinates. Select the vertical coordinates (elevation), the horizontal coordinates (northing and easting values), or all of these together.
- The origin of the horizontal adjustment is the first point in the calibration when using one or two calibration point pairs. When there are more than two calibration point pairs, the computed centroid position is used for the origin.
- The origin of the vertical adjustment is the first point in the calibration with an elevation.
- When reviewing a calibration point in the database, notice that the **Global** values are the **measured** coordinates. The grid values are derived from these, using the current calibration.

The original keyed-in coordinates remain unchanged. (They are stored elsewhere in the database as a point with the **Type** field showing **Keyed in coordinates** and the **As stored** field showing **Grid**.)

- When you are calibrating a no projection, no datum job, (where ground coordinates are required after calibration) you must define the project height (average site height). When the job is calibrated, the project height is used to compute a ground scale factor for the projection, using the inverse of the ellipsoid correction.
- When you start a Scale Factor Only job and then introduce GNSS data, you must perform a site calibration to relate the GNSS data to the Scale Factor Only point coordinates.

When you select **Site Calibration**, you must specify whether the Scale Factor Only coordinates in the job represent grid coordinates or ground coordinates. The site calibration computations then set up a grid coordinate system or a ground-based coordinate system, that best fits the existing data in the job to the GNSS data.

#### To configure the survey style for a site calibration

1. Tap  and select **Settings / Survey styles**. Select the required survey style.
2. Tap **Site calibration**.
3. The **Fix H. scale field to 1.0**: check box details whether the calibration computation should compute a horizontal scale factor or not:
  - To compute the horizontal scale factor, make sure the check box is clear. (This is the default setting.) Use this option only if GNSS measurements need to be scaled to fit the local control. (GNSS measurements are usually more precise.)
  - To fix the horizontal scale factor to 1.0, select the check box. Select the check box to avoid distorting the geometry of the GNSS network, but note that the calibration residuals will be higher.
4. For the Origin software to automatically perform a calibration when you measure a calibration point, select the **Auto calibrate** check box. To switch automatic calibration off, clear the check box.

5. Select the vertical adjustment type to be computed and applied:
  - The **Constant adjustment only** option will compute a vertical shift value to best fit the calibration point measured elevations to the control elevations.
  - The **Inclined plane** option will compute a vertical shift plus north and east inclinations to best fit the calibration point measured elevations to the control elevations. Typically, the Inclined plane method will result in smaller vertical residuals than the Constant adjustment only method.
6. Select an observation type appropriate to a calibration point. The options for a calibration point are topo point or observed control point.

**NOTE** – If you set the observation type to **Topo point**, all settings are defined in the survey style for a [topo point](#).

7. If necessary, set the tolerances for maximum horizontal and vertical residuals, and maximum and minimum horizontal scale settings. These settings only apply to automatic calibration and do not affect manual calibration.

You can also specify the maximum slope of the vertical adjustment plane. The software warns you if the slope in the north direction or the slope in the east direction exceeds this. Generally the default settings are appropriate.

8. Specify how the calibration points you measure will be named:
  - In the **Method** field, choose one of the following options: **Add prefix**, **Add suffix**, or **Add constant**.
  - In the **Add** field, enter the prefix, suffix, or constant.

The table below shows the different options and gives an example of each.

Option	What the software does	Example value in the Add field	Grid point name	Calibration point name
Same	Gives the calibration point the same name as the grid point	–	100	100

Add prefix	Inserts a prefix before the grid point name	GNSS_	100	GNSS_100
Add suffix	Inserts a suffix after the grid point name	_GNSS	100	100_GNSS
Add constant	Adds a value to the grid point name	10	100	110

### To automatically calibrate points

When you use this function to measure calibration points, the calibration calculations are performed and stored automatically.

**NOTE** – If you do not define a projection and datum transformation, a transverse mercator projection will be used.

1. Set your automatic calibration settings in the **Site calibration** screen.
  - a. To view the **Site calibration** screen, do one of the following:
    - Tap  and select **Settings / Survey styles**. Select the required survey style. Tap **Site calibration**.
    - When you measure a calibration point, tap **Options**.
  - b. Select the **Auto calibrate** check box to display calibration residuals only if the calibration tolerances are exceeded.
  - c. Configure the naming relationship between the grid and **Global** coordinates.
  - d. Tap **Accept**.
2. Enter the grid coordinates of your calibration points. Key these in, transfer them from your office computer, or measure them using a conventional total station.

For keyed in coordinates check that the coordinate fields are **North**, **East**, and **Elevation**. If they are not, tap **Options** and change the **Coordinate view** to Grid. See [Coordinate view settings, page 210](#).

Key in the known grid coordinates and tap **Enter**.

Select the **Control point** check box. (This ensures that the point is not overwritten by a measured point.)

For transferred coordinates make sure that these coordinates are:

- transferred as grid coordinates (N, E, E), not as **Global** coordinates (L, L, H)
  - control class points
3. Measure each point as a calibration point.
    - a. In the **Method** field, select **Calibration point**.
    - b. Enter the grid point name. The software names the GNSS point automatically, using the naming relationship that you configured earlier.

Once the point has been measured, the Auto-calibrate function matches the points (grid and Global coordinates), and calculates and stores the calibration. The calibration is applied to all previously measured points in the database.

4. When you measure the next calibration point, a new calibration is calculated using all of the calibration points. It is stored and applied to all previously measured points.

When one point has been calibrated, or a projection and datum transformation have been defined, the **Find** softkey appears. You can use this to navigate to the next point.

If the calibration residuals are exceeded, consider removing the point with the most extreme residuals. Do one of the following:

- If at least four points are left after removing that point, recalibrate using the remaining points.
- If not enough points are left after removing that point, measure it again and recalibrate.

It may be necessary to remove (remeasure) more than one point. To remove a point from the calibration calculations:

1. Highlight the point name and tap **Enter**.
2. In the **Use** field, select **Off** and tap **Enter**. The calibration is recalculated and the new residuals are displayed.
3. Tap **Apply** to accept the calibration.

To view the results of an automatic calibration:

1. Tap  and select **Measure / Site calibration**. The **Site calibration** screen appears.
2. Tap **Results** to see the **Calibration results**.

### To manually calibrate points

Key in the grid coordinates of your control points. Alternatively, transfer them from your office computer, or use a conventional instrument to measure them. Then measure the points with GNSS.

1. Tap  and select **Measure / Site calibration**.
2. For **Scale factor only** jobs:
  - If the job uses ground coordinates, select **Ground**.
  - If the job uses grid coordinates, select **Grid**.
3. To add a point to the calibration, tap **Add**.
4. Enter the name of the grid point and the GNSS point in the appropriate fields.

The two point names do not have to be the same, but they should correspond to the same physical point.

5. Change the **Use** field as required and tap **Accept**.

The calibration residuals screen appears.

6. Tap **Results** to see the horizontal and vertical shifts that the calibration has calculated.
7. To add more points, tap **Esc** to return to the calibration screen.
8. Repeat steps 3 through 6 until all the points are added.
9. Do one of the following:
  - If the residuals are acceptable, tap **Apply** to store the calibration.
  - If the residuals are not acceptable, recalculate the calibration.

### To recalculate the calibration

Recalculate a calibration if the residuals are not acceptable, or to add or remove points.

1. Tap  and select **Measure / Site calibration**.
2. Do one of the following:
  - To remove (exclude) a point, highlight the point name and then tap **Remove**.
  - To add a point, tap **Add**.

- To change the components used for a point, highlight the point name and tap **Edit**. In the **Use** field, choose whether to use the vertical coordinate of the grid point, the horizontal coordinates, or both horizontal and vertical coordinates.

3. Tap **Apply** to apply the new calibration.

**NOTE** – Each calibration calculation is independent of the previous one. When a new calibration is applied, it overwrites any previously calculated calibration.

## Receiver functions and settings

The **GNSS Instrument** menu provides information about the GNSS receiver connected to the controller, and is used to configure the settings for the GNSS receiver. Available options depend on the type of receiver that is connected.

**NOTE** – If a conventional instrument is also connected and you are performing an integrated survey, additional items appear in the **Instrument** menu. For more information, see [Instrument functions and settings, page 322](#).

### GNSS functions

To access the **GNSS functions** screen, tap the receiver icon in the status bar.

Use the **GNSS functions** screen to control commonly-used functions for the connected GNSS receiver, such as switching Bluetooth connections between the configured base and rover receivers, starting or ending the survey, or powering down the receiver. The **GNSS functions** screen also provides fast access to detailed information including receiver status, position details, and available satellites.

The functions available depend on the receiver that the controller is connected to, and the mode the receiver is operating in. A yellow button indicates the function is enabled.

**TIP** – When in the **GNSS functions** screen, you can use the controller keypad to enter the keypad character (**1-9, 0, -** or **.**) indicated on the tile to enable/disable the function or open the appropriate screen. If you have configured a function key on the controller as a shortcut to a GNSS function, you can press the configured function key when viewing any screen in the software.

### Base mode

When **Base** mode is enabled, when you start the software Origin attempts to connect to the receiver configured in the **Connect to GNSS base** field in the **Bluetooth** tab of the **Connections** screen. The receiver icon in the status bar indicates if the software is in **Base** mode.

If there is no receiver configured, the software checks if there is a receiver connected to the controller's serial port. When the software is in **Base** mode, if a receiver is found on the serial port it is treated as the base receiver.



In **Base** mode the **Start survey** and **End survey** buttons in **GNSS functions** start or end a base survey using the current survey style.

### Rover mode

When **Rover** mode is enabled, when you start the software Origin attempts to connect to the receiver configured in the **Connect to GNSS rover** field in the **Bluetooth** tab of the **Connections** screen. The receiver icon in the status bar shows if the software is in **Rover** mode.

If there is no receiver configured, the software checks if there is a receiver connected to the controller's serial port. When the software is in **Rover** mode, if a receiver is found on the serial port it is treated as the rover receiver.

In **Rover** mode the **Start survey** and **End survey** buttons in **GNSS functions** start or end a rover survey using the current survey style.

### Bluetooth

Tap **Bluetooth** to view the **Bluetooth** tab of the **Connections** screen and [configure separate Bluetooth connections](#) to the base and rover receivers. Then use the **Base mode** and **Rover mode** buttons in the **GNSS functions** screen to switch between and connect to the receivers.

### Data link

You can tap the **Data link** button to connect to and configure the radio you are using for your RTK data link.

When the instrument is in **Rover** mode, tap **Data link** to go to the **Rover data link** settings screen.

When the instrument is in **Base** mode, tap **Data link** to go to the **Base data link** settings screen.

If the softkey displays **>Rover** or **>Base** tap the softkey to switch to the appropriate mode and then tap **Connect**.

If there is an RTK survey running, the radio screen shows the radio currently in use, and you may not be able to connect to an external radio.

When a survey is not running, you can select the type of RTK radio you are using and then tap **Connect** (if it is available) to connect to and configure the communication settings in the radio. You can review and set the radio frequency, baud rate, and other settings if they are available to change in the radio device that the instrument is connected to. See [Configuring a radio data link](#).

**NOTE** – *You cannot edit survey style settings in this screen. If you start a survey with a **different** type of radio set in the survey style, the system uses that radio – not the radio that you set in **GNSS functions**.*

### Start survey, end survey, power down receiver

To start a GNSS survey, tap **Start survey**.

To end the survey, tap **End survey**. You are prompted to power down the receiver. Tap **Yes** or **No**, as required.

To power down the receiver after ending a survey, tap **Power down receiver**.

### Satellites

To view information about the satellites being tracked, tap **Satellites**. See [Satellite information, page 402](#).

### Position

To view and store the current position, tap **Position**. See [Current position information, page 405](#).

### Navigate to point

To navigate to a point, tap **Navigate to a point**. See [Navigate to a point, page 406](#).

### Import from receiver and export to receiver

To import files from or export files to the receiver, tap **Import from receiver** or **Export to receiver**. See [Transfer receiver files, page 407](#).

### Receiver status

To view the status of the receiver, tap **Receiver status**. See [Receiver status, page 418](#).

### Satellite information

To view information about the satellites currently being tracked by the receiver, tap the satellite icon  in the status bar.

In the **Satellites** screen, you can select the following options:

- To stop the receiver tracking a satellite, tap the satellite to display the satellite information and then tap **Disable**.
- To change the elevation mask and the PDOP mask for the current survey, tap **Options**. See [Rover options, page 345](#).
- To enable SBAS outside of a survey, tap **Options** and then select **Enable SBAS**.
- In a postprocessed survey, the **L1** softkey appears in the **Satellites** dialog. Tap **L1** to display a list of cycles tracked on the L1 frequency for each satellite.

The value in the **CntL1** column is the number of cycles on the L1 frequency that have been tracked continuously for that satellite. The value in the **TotL1** column is the total number of cycles that have been tracked for that satellite since the start of the survey.

- With a dual-frequency receiver, the **L2** softkey appears in the **Satellites** dialog. Tap **L2** to display a list of cycles tracked on the L2 frequency for each satellite.

The **SNR** softkey appears. Tap **SNR** to return to the original screen and view information about the signal-to-noise ratio for each satellite.

### Satellite identification

A satellite is identified by the space vehicle (SV) number.

- GPS satellite numbers are prefixed with a "G".
- GLONASS satellite numbers are prefixed with an "R".
- Galileo satellite numbers are prefixed with an "E".
- QZSS satellite numbers are prefixed with a "J".
- BeiDou satellite numbers are prefixed with a "C".
- RTX satellites are identified as "RTX".

### Skyplot

To view a graphical representation of the position of satellites, tap **Plot**.

- Tap **Sun** to see the plot oriented towards the sun.
- Tap **North** to see the plot oriented towards north.
- The outside circle represents the horizon or 0° elevation.
- The inner, solid green, circle represents the elevation mask setting.
- The SV numbers on the diagram are placed in the position of that particular satellite.
- Satellites that are tracked but not used in the position solution appear in blue.
- The zenith (90° elevation) is the center of the circle.

**NOTE** – *An unhealthy satellite is shown in red.*

If a satellite is not being tracked and you expect that it should be:

- Check that there are no obstructions – look at the azimuth and elevation of the SV in the skyplot.
- Tap the SV number and make sure the satellite is not disabled.

- Make sure there are no transmitting antennas nearby. If there are, reposition the GNSS antenna.

### Satellite list

To view the list of satellites, tap **List**.

- In the list of satellites, each horizontal line of data relates to one satellite.
- Azimuth ( **Az** ) and elevation ( **Elev** ) define a satellite's position in the sky.
- The arrow displayed next to the elevation indicates whether the elevation is increasing or decreasing.
- The signal-to-noise ratios (SNR) indicate the strength of the respective satellite signals. The greater the number, the better the signal.
- If a signal is not being tracked, then a dashed line (-----) appears in the appropriate column.
- The check mark on the left of the screen indicates whether that satellite is in the current solution, as shown in the following table.

Situation	A check mark indicates the satellite
No survey is running	Is being used in the current position solution
RTK survey is running	Is common to the base and rover receivers
Postprocessed survey is running	Is one for which one or more epochs of data have been collected

To see more information about a particular satellite, tap the appropriate line.

### To use independent subsets of satellites tracked in RTK surveys

Some regulatory authorities require "independent" measurements of points in RTK surveys. This can include making repeated occupations at different times of day to ensure a change in satellite constellation. The **SV subset** function divides all tracked satellites into two subsets with an even spread throughout the sky, and can be used to measure and then remeasure the point using independent occupations without having to return at another time.

**NOTE** - *Spectra Geospatial recommends only using SV subsets when tracking the most available satellites and constellations at your location. This helps ensure each subset has enough satellites to ensure good DOP for each independent occupation.*

In the **Satellites** screen:

- To switch SV tracking to the first subset, tap the **SV set A** softkey.
- To switch SV tracking to the second subset, tap the **SV set B** softkey.
- To re-enable all SVs tap the **All** softkey.

When starting or ending a survey, all satellite tracking for the constellations selected in the survey style are re-enabled.

**NOTE** – Use of the SV subset function takes full control over enabling and disabling SVs and overrides any custom enabling or disabling of satellites.

**TIP** – The SV subset functions can also be selected from the **Method** field in the [RTK Initialization screen](#).

To change which satellites are being tracked

**NOTE** – If you disable a satellite, it remains disabled until you enable it again. Even when the receiver is switched off, it stores that a satellite is disabled.

To enable or disable the tracking of entire constellations such as all GLONASS or all BeiDou satellites, use the check boxes in the **GNSS Signal Tracking** group box. Ensure you have enough SVs enabled for RTK to operate optimally, as disabling entire constellations can compromise GNSS receiver performance.

**NOTE** – Individually disabled satellites are not affected by changes to the check boxes in the **GNSS Signal Tracking** group. If an SV is already disabled it remains disabled when the constellation it belongs to is disabled or enabled.

To enable or disable tracking of SBAS satellites

When you start a survey configured to use SBAS with Origin, the appropriate satellites are enabled in the receiver so that they can be tracked. To use a different SBAS satellite

1. Start the survey with the SBAS enabled style.
2. Tap the satellite icon in the status bar.
3. Tap the SV number of the satellite.
4. Tap **Enable** or **Disable**.

The SBAS satellites remain enabled or disabled until the next time that you start a new survey.

Current position information

If the controller is connected to a GNSS receiver, tap the receiver icon in the status bar and select **Position** to view the current position of the receiver.

**NOTE** – When using a controller with internal GPS, a connected GNSS receiver is always used in preference to the internal GPS.

If the antenna height is defined, the software calculates the position of the pole tip.

If a GNSS receiver with a built-in tilt sensor is being used, the current tilt distance is shown.

**NOTE** – The **Position** screen does not apply the tilt correction to positions, therefore the position displayed is the uncorrected position.

To store the current position, tap **Store**. See [To store a point, page 172](#).

The position is shown in the coordinates selected in the **Coordinate view** field. Tap **Options** to change the [Coordinate view settings, page 210](#).

To view the position of the base antenna, tap **Base**.

### Navigate to a point

If the controller is connected to a GNSS receiver, or you are using a controller with internal GPS, you can navigate to a point

- during a conventional survey if you lose lock to the target
- before you start a survey.

**NOTE** – When using a controller with internal GPS, a connected GNSS receiver is always used in preference to the internal GPS.

The **Navigate to point** function uses the settings in the last used GNSS survey style.

**NOTE** – If you are using a GNSS receiver that can track SBAS signals, when the radio link is down you can use SBAS positions instead of autonomous positions. To use SBAS positions, set the **Satellite differential field** in the survey style to SBAS.

1. To navigate to a point, you can
  - Select the point in the map. Tap and hold in the map and select **Navigate to point**.
  - Tap  and select **Instrument** or **Receiver / Navigate to point**.
2. Fill out the other fields as required.
3. To change the display mode, tap **Options**. The display options are the same as the display options in the **Stakeout options** screen. See [Stakeout navigation display, page 504](#).
4. Tap **Start**.

5. Use the arrow to navigate to the point, which is shown as a cross. When you are close to the point, the arrow disappears and a bull's-eye symbol appears. A grid also appears and changes scale as you move closer to the target.

When you are on the point, the bull's-eye symbol covers the cross.

6. If required, mark the point.
7. To store the point, tap **Position** and then tap **Store**.

### Transfer receiver files

If the controller is connected to a receiver that supports the transfer of receiver files, you can transfer files to and from the controller to the receiver.

The **Import from receiver** option is available when a Spectra Geospatial GNSS receiver is in use. Use it to delete files in the connected receiver, or to copy files from the connected receiver to the controller.

#### **NOTE -**

- *To access the external memory of a receiver that supports both internal and external memory, tap on the **Parent** folder from the Internal directory and then tap on **External**.*
- *You cannot restore deleted receiver files.*

The **Export to receiver** option is available when a Spectra Geospatial GNSS receiver is in use that has a compact flash card inserted. Use it to copy files from the controller to the connected receiver.

You can transfer files only to and from the **current [project folder](#)** on the controller.

### To import files from the receiver to the controller

1. Tap  and select **Instrument / Receiver files / Import from receiver**.

All files stored in the receiver are shown.

2. Tap the file(s) to transfer.

**NOTE -** *To see more information about a file, select it and tap **Info**. To delete a file, select it and tap **Delete**. To select all files in the current directory, tap **All**.*

3. Tap **Import**. The **Copy file to Spectra Geospatial Controller** screen appears.
4. Tap **Start**.

### To export files from the controller to the receiver

1. Tap  and select **Instrument / Receiver files / Export to receiver**.

All files in the current project folder on the controller are shown.

2. Tap the file(s) to transfer.
3. Tap **Export**.
4. Tap **Start**.

### Receiver settings

To view the configuration of the connected GNSS receiver, tap and hold on the receiver icon in the status bar.

The **Receiver settings** screen shows information about the type, firmware version, and capabilities of the connected receiver.

Use the softkeys at the bottom of the screen to configure additional settings.

To configure:

- a Bluetooth connection to the receiver, tap **Bluetooth**.
- GNSS eBubble options, tap **eBubble**. See [GNSS eBubble tilt sensor, page 409](#).
- the RTX satellites that are being used, tap RTX SV. See [To view RTX status, page 386](#).

### To configure Wi-Fi settings for the receiver

To configure the Wi-Fi settings in a receiver that is Wi-Fi enabled:

1. Connect to the receiver but do not start a survey.
2. Tap  and select **Instrument / Receiver settings** and tap **Wi-Fi**.

If the **Wi-Fi** softkey is not shown, make sure you have not started a survey.

3. Select the **Mode**. Three modes are supported:
  - Off
  - Access point: Use this mode to enable the receiver as an access point so that many clients can connect to it.
  - Client: Use this mode to enable the receiver to connect to an existing network.



**NOTE** – Enabling Access point or Client mode will shorten the run time of the receiver battery.

4. Configure the settings as required. Refer to the receiver manual for further details.

**TIP** – To use the receiver as a mobile Wi-Fi hotspot when the receiver is operating as an access point, select the **Mobile hotspot** check box. This option is only supported when the receiver is connected to the Internet using its internal modem and **Route through controller** is disabled in the GNSS contact.

5. To update the receiver with the new settings, restart the receiver.

### GNSS tilt sensors

Spectra Geospatial receivers with built-in sensors provide **tilt compensation**, which allows you to measure points when the **pole is tilted and the receiver is not level**. The type of tilt compensation available depends on the receiver.

**TIP** – Well-calibrated tilt sensors are essential for accurate results. Origin provides a number of calibration routines for your receiver. To view the **Sensor calibration** screen, tap  and select **Instrument / Tilt sensor options** and then tap the **Calib.** softkey.

### GNSS eBubble

The GNSS eBubble is an electronic representation of the degree of tilt of the receiver. Use the GNSS eBubble to ensure the pole is vertical, still and stable when measuring a point.

The GNSS eBubble appears automatically when you are using a Spectra Geospatial SP80 or SP85 receiver and **Tilt functions** are enabled in the survey style.

For more information, see [GNSS eBubble tilt sensor, page 409](#).

### Magnetometer tilt compensation

Spectra Geospatial SP80 and SP85 receivers have a built-in magnetometer that allows you to measure points with a tilted pole using the **Compensated point** method. A compensated point uses the magnetometer to calculate the direction of tilt.

For more information, see [Magnetometer tilt compensation, page 415](#).

### GNSS eBubble tilt sensor

The GNSS eBubble uses the accelerometers in the receiver to provide an electronic representation of the degree of tilt of the receiver.

The GNSS eBubble appears automatically when you are using a Spectra Geospatial SP80 or SP85 receiver and **Tilt functions** are enabled in the survey style.

**TIP** – If you have previously chosen to hide the GNSS eBubble for the current measurement method, it does not appear automatically. To show or hide the GNSS eBubble:

- In the Measure screen, tap the **eBubble** softkey.
- To show or hide the eBubble from any screen, press **Ctrl + L**.
- To move the eBubble window to a new position on the screen, tap and hold on the eBubble and drag to a new position.

#### To make sure the antenna is level

Use the eBubble to ensure the pole is vertical, still and stable when measuring a point, or that the receiver is within the required tilt tolerance. For example:

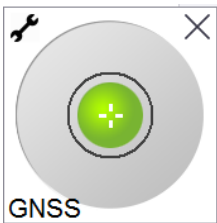

The circle on the **eBubble** vial represents the configured tilt tolerance. **Tilt tolerance** is defined as the distance on the ground (**tilt distance**) that the tilt represents given the antenna height:

- A green bubble indicates the receiver is within the defined tilt tolerance and the point can be measured.
- A red bubble indicates the receiver is outside the defined tilt tolerance. Depending on the configured tilt warnings, a warning message may also appear if the eBubble is red. See [GNSS eBubble tilt warnings, page 412](#).

If the antenna is outside the tilt tolerance, adjust the pole angle to be within the tilt tolerance.

Alternatively, increase the tilt tolerance.

To store a position that is outside the configured tilt tolerance, tap . A warning record is associated with the point.



Configure the **Tilt tolerance** for each point type in the survey style, or tap options in the **Measure** screen. See [GNSS point options, page 356](#).

**NOTE** – For best results, when using the GNSS eBubble make sure that:

- You are looking directly at the receiver LED panel. This is because the GNSS eBubble is aligned to the receiver LED panel.
- The GNSS eBubble is properly calibrated. The accuracy of tilt information used to display the GNSS eBubble and stored with measured points depends on the quality of the eBubble calibration. Using a poorly-calibrated GNSS eBubble degrades the accuracy of the coordinates measured using the eBubble as a level reference.

### GNSS eBubble options

You can configure the sensitivity and responsiveness of the GNSS eBubble in the **GNSS eBubble options** screen. To view this screen you can:

- Tap  in the **eBubble** window.
- Tap and hold the receiver icon in the status bar to view the **Receiver settings** screen and then tap **eBubble**.
- Tap  and select **Instrument / Tilt sensor options**.

**TIP** – If you have more than one tilt sensor connected, you can also tap the **GNSS** softkey from the **eBubble options** screen for a different sensor. Changing the eBubble settings for one sensor changes the eBubble settings for all connected tilt sensors.

You can configure the following settings:

Option	Description
<b>eBubble sensitivity</b>	The eBubble moves 2 mm for the specified sensitivity angle. To decrease sensitivity select a large angle.
<b>Tilt tolerance</b>	Defines the maximum radius that the receiver can tilt and be considered in tolerance. The allowable range is 0.001 m to 1.000 m.
<b>eBubble response</b>	Controls the eBubble's responsiveness to movement.
<b>Tilt distance</b>	The tilt distance shown is calculated using the current antenna height.
<b>eBubble calibration status</b>	Current calibration status. To recalibrate the eBubble, tap <b>Calib</b> .

Option	Description
<b>Calibration expires in</b>	The date that the current calibration will expire. The eBubble must then be recalibrated.
<b>Calibration age limit</b>	Displays the time period between calibrations. At the end of the time period the software will prompt you to recalibrate the eBubble. To edit the default value tap the pop-up arrow.
<b>Size</b>	The size of the eBubble window. A value of <b>1.0</b> is the default size for most controllers. When running on a Ranger 5, the default value is 0.8. When running on a MobileMapper 60, the default value is 1.5.

### GNSS eBubble tilt warnings

Tilt warnings apply only when the GNSS eBubble tilt sensor is being used. Specifically, when you are using a Spectra Geospatial SP80 or SP85 receiver.

You can configure the software to warn if, during point measurement, the receiver tilts more than the required tilt tolerance.

When tilt warnings are enabled a measurement can only be stored when the **eBubble** is green and within the tolerance circle.

To configure required tilt tolerance and tilt warnings

1. Enter the tilt threshold value in the **Tilt tolerance** field in the point method screen of the survey style. You can enter a different value for each point method.

If the **Tilt warnings** check box is not selected, the GNSS **eBubble** indicates when the receiver is outside the specified tolerance but no warnings are displayed.

2. Select the **Tilt warnings** check box to display warnings when the antenna tilts more than the value entered in the **Tilt tolerance** field.

If tilt warnings are configured:

- If the GNSS eBubble is red indicating the receiver is outside the tilt tolerance when you start to measure a topo or observed control point, a warning message appears. Tap **Yes** to continue measuring the position.

- An **Excess tilt detected while measuring** message appears if you have had excess tilt at any time during the measurement process.
  - An **Excess tilt** message appears if you have had excess tilt at the time of storage.
3. Use the **Auto-abandon** and **Auto-measure** check boxes to control what happens if **excess tilt** or **excess movement** is detected when measuring a topo point or observed control point:
- Select the **Auto abandon** check box to automatically abandon the point if excess tilt or excess movement is detected. If the **Auto abandon** check box is not selected and excess tilt or excess movement is detected, you must choose whether to accept the point, abandon it, or remeasure it.
  - Select the **Auto-measure** check box to automatically start measuring a topo point when the precisions and tilt are within tolerance, and no excess movement is detected.
  - Select both the **Auto abandon** and **Auto-measure** check boxes to automate the re-measure of points that do not meet your requirements. If excess tilt or excess movement is detected when both check boxes are selected, the point is automatically abandoned and the software shows **Waiting for level**, indicating the measurement will start as soon as the receiver is level and stationary.

#### GNSS eBubble calibration

The GNSS eBubble uses the accelerometers in the receiver to provide an electronic representation of the degree of tilt of the receiver.

GNSS eBubble calibration aligns the accelerometers in the receiver to the physical sensor used to measure tilt.

#### When to calibrate the GNSS eBubble

The GNSS eBubble calibration takes 30 seconds to complete. You must perform the GNSS eBubble calibration:

- The first time you use the receiver.
- When the previous calibration expires.
- After completing a pole bias adjustment.

- If the GNSS receiver suffers severe abuse such as a pole drop.
- If the temperature inside the receiver is more than 30° Celsius different to when the eBubble calibration was performed, the calibration is invalidated.
- If the Origin software detects the GNSS eBubble is not calibrated and displays the warning message **Calibration required to use eBubble tilt functions. Calibrate now?**

#### Before performing the GNSS eBubble calibration

Take great care when calibrating the eBubble to make sure the most accurate tilt information is available at all times, including:

- **Bubble reference:** Calibrate the GNSS eBubble against a properly calibrated reference, such as the physical vial. The accuracy of the eBubble depends totally on the accuracy of the reference used to calibrate it.
- **Pole stability:** When calibrating the GNSS eBubble, the pole the GNSS receiver is on should be as vertical and as stable as possible. In practice this means using at least a bipod to hold the pole as still as possible.
- **Pole straightness:** The straightness of the pole affects the tilt measured by the sensors in the GNSS receiver. If you change poles, and the poles are not both in excellent condition, you should recalibrate the GNSS eBubble.

#### To calibrate the eBubble

**NOTE** – Calibration routines should not be left incomplete. You should not need to navigate to a different screen during the calibration, but if you choose to navigate to a different screen, Spectra Geospatial recommends that you first complete the calibration process, or tap **Cancel** to cancel the calibration.

1. Set up the receiver so that the pole the GNSS receiver is on is as vertical and as stable as possible, and the receiver has a clear view of the sky.
2. Make sure the receiver LED panel is facing you.
3. Tap  and select **Instrument / Tilt sensor options**.
4. Tap the **Calib.** softkey to open the **Sensor calibration** screen.
5. Tap **Calibrate**.

- Keep the pole stable and vertical until the progress bar completes.

Once complete, the software returns to the **Sensor calibration** screen.

- If the receiver has a built-in magnetometer, you must recalibrate the magnetometer because calibrating the eBubble invalidates the magnetometer alignment. See [Magnetometer calibration, page 417](#).
- To close the **Sensor calibration** screen, tap **Accept**.

The details of the calibration are stored in the job. To review them, tap ☰ and then select **Job data / Review job**.

#### Magnetometer tilt compensation

Spectra Geospatial SP80 and SP85 receivers have a built-in magnetometer that allows you to measure points with a tilted pole using the **Compensated point** method.

#### Compensated points

The compensated point measurement method uses the tilt sensor and magnetometer built into the receiver to compute the position of the pole tip. The **Compensated point** method appears in the list of available measurement methods during a GNSS survey when the **Tilt functions** check box is enabled in the **Rover options** screen of the survey.

Measuring a compensated point is useful when:

- You want to measure point more quickly without spending time making sure the pole is level.
- An obstruction means that you are unable to position the antenna directly above the point.

Traditionally you would need to use an offsetting technique to measure such points. Using the compensated point measurement method corrects the antenna's offset location to produce a ground position at the tip of the pole.

When measuring a compensated point, the tilt sensor measures the tilt of the antenna and calculates the offset from the pole tip. The graduations in the eBubble vial represent the sphere through which the antenna moves when the pole tip is stationary. For example:

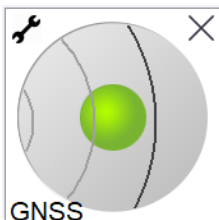

Bubble color	Tilt range	Meaning
Green	< 12 degrees	You are within the tilt tolerance for a compensated point.
Yellow	12 to 15 degrees	You are close to exceeding the tilt tolerance for a compensated point.
Red	> 15 degrees	You have exceeded the tilt tolerance for a compensated point.

### Magnetic disturbance

The system attempts to detect the amount of magnetic disturbance in the environment by comparing the sensed magnetic field with the expected magnetic field. The expected magnetic field comes from a model of the earth's magnetic field stored in the receiver. The magnetometer senses the magnitude (strength) and the vertical direction (inclination angle) of the environment's magnetic field and compares it to the expected magnitude and vertical direction for the location. If the values do not match, then magnetic disturbance is detected.

The level of magnetic disturbance is indicated by the **Magnetic disturbance** value, which uses a scale from 0 to 99. The level of magnetic disturbance is also reflected in the precision estimate. If you have correctly calibrated the magnetometer and are working in an environment free of magnetic interference, then you should see magnetic disturbance values lower than 10.

If the value is higher than 50, a warning is displayed on the status line. If the value is 99 you will not be able to store the point unless the pole's tilt distance is within 1 cm of level. Check the vicinity for sources of magnetic interference. If there are no obvious sources of magnetic disturbance, check your calibration.

You can view the **Magnetic disturbance** value for a point in the **Review Job** screen.



**WARNING** – In magnetically disturbed environments it is possible for the magnetometer to sense the expected magnitude and vertical direction values but an incorrect horizontal direction. It is impossible to detect this. If this happens, the software reports low magnetic disturbance values when in fact there are large magnetic azimuth errors. To avoid these errors, it is important to use compensated points only in areas free of magnetic disturbance.

**TIP** – Only the horizontal position is dependent on the magnetometer. If your survey requires high vertical accuracy but horizontal accuracy is less important, then magnetic interference may be less significant. The horizontal quality of the point degrades more at a higher tilt angle with higher magnetic disturbance. In other words, magnetic disturbance has no effect if the pole is level.



## Magnetometer calibration

Spectra Geospatial recommends calibrating the **magnetometer** in the SP80 or SP85 receiver:

- Each time you replace the battery.
- If the GNSS receiver suffers severe abuse such as a pole drop.
- If the temperature inside the receiver is more than 30° Celsius different to when the [GNSS eBubble calibration](#) was performed. This high temperature invalidates the GNSS eBubble calibration, which in turn invalidates the magnetometer alignment.



**WARNING** – The performance of the magnetometer is affected by nearby metal objects (for example, vehicles or heavy machinery) or objects that generate magnetic fields (for example, high voltage overhead or underground power lines). Always calibrate the magnetometer away from sources of magnetic disturbance. In practice this usually means outdoors. (Calibrating the magnetometer near sources of magnetic disturbance **does not** "correct" for the interference caused by these objects.)

---

## To calibrate the magnetometer

**NOTE** – Calibration routines should not be left incomplete. You should not need to navigate to a different screen during the calibration, but if you choose to navigate to a different screen, Spectra Geospatial recommends that you first complete the calibration process, or tap **Cancel** to cancel the calibration.

1. Tap **☰** and select **Instrument / Tilt sensor options**.
2. Tap the **Calib.** softkey to open the **Sensor calibration** screen.
3. In the **Sensor calibration** screen, tap **Calibrate** beside **Magnetometer calibration status**.
4. Detach the receiver from the pole.
5. Tap **Start**. Rotate the receiver as shown on-screen for a minimum of 12 different orientations, until calibration is complete.
6. Tap **Accept**.
7. Reattach the receiver to the pole. Use the GNSS eBubble to make sure the pole is as vertical as possible.

8. Tap **Calibrate** beside **Magnetometer alignment status**.
9. Tap **Start**. Rotate the receiver slowly and smoothly around its vertical axis until calibration is complete.
10. Tap **Accept**.

The details of the calibration are stored in the job. To review them, tap  and select **Job data / Review job**

### Receiver status

To view the receiver status, tap the receiver icon in the status bar and then tap **Receiver status**.

The **Status** section shows the GPS time and GPS week, the current temperature and the amount of memory in the receiver.

The **Battery** section shows the power level of the receiver battery.

The **External power** section shows the status of the external connectors in the receiver.

### GSM status



To view the GSM status, tap  and select **Instrument / GSM Status**. The GSM status is available only when connected to a receiver that has an internal modem.

**NOTE** – *The GSM status is not available when the receiver's internal modem is connected to the Internet.*

The **GSM status** screen shows the status reported by the modem at the time you select **GSM status**, or when you tap **Refresh**.

If you set a PIN on the SIM card and the modem is in a locked state, you must key in the SIM PIN to be sent to the modem. The PIN is not stored, but the receiver remains unlocked with the correct PIN until you turn off the power and then turn it on again.

**NOTE** – *After three attempts to unlock the SIM card using an incorrect PIN, the SIM card is blocked, except for emergency calls. You are prompted to enter a PUK (Personal Unblocking Key) code. If you do not know the PUK for your modem, contact the supplier of the modem SIM card. After ten unsuccessful attempts to enter the PUK, the SIM card is invalidated and is no longer operable. When this occurs, you must replace the card.*

**Network operator** shows the current network operator. The home network icon  shows that the current network operator is the home network for the active SIM card. The roaming network icon  shows that the current network operator is not the home network.

**Select network** shows a list of network operators obtained from the mobile network after performing a scan for available networks. To populate the list, tap **Scan**.

When you tap **Scan**, the modem queries the mobile network for the list of network operators. Poor reception can result in fewer networks being returned by the network when the modem queries it for the list.

Some SIM cards are locked to specific networks. If you select a network operator that is forbidden by the host network, the system shows one of the following messages: **Failed to select network operator** or **Network not allowed – emergency calls only**.

Select **Automatic** to put the modem into 'automatic' network selection mode. The modem then searches for all network operators and tries to connect to the most appropriate network operator, which may or may not be the home network.

If you select any other network operator from **Select network**, the modem goes into 'manual' selection mode and tries to connect with the selected network operator.

If you select **GSM status** or tap **Refresh** while in 'manual' mode, the modem searches only for the last manually-selected network operator.

For a list of network operators that you can connect to, contact your subscribed network operator.

**Signal strength** shows the GSM signal strength.

**Firmware version** shows the modem firmware version.

### RTK network status

If you are performing an RTK survey and the reference station or network server that you receive base station data from supports status messaging, tap  and select **Instrument / RTK network status** to view the reported status of the reference station server, and the options the reference station supports, such as **RTK on Demand**.

Use the options in the **RTK network status** screen to configure whether notifications should pop up on screen and/or be stored in the job.



The reference station message, shown in the **Latest Reference Station message** field, is typically transmitted in an RTCM type 1029 text message.

## Integrated surveys

In an **integrated survey**, the controller is connected to both a conventional survey instrument and a GNSS receiver at the same time. The Origin software can quickly switch between the two instruments, within the same job.

To use an integrated survey, you must configure the conventional and RTK survey styles you will use, and then configure an integrated survey style which references the conventional survey style and the RTK survey style. The default integrated survey style is called **IS Rover**.

### To configure the integrated survey style

1. Tap  and select **Settings / Survey styles**.
2. Tap **New**.
3. Enter the **Style name** and set the **Style type** to **Integrated Surveying**. Tap **Accept**.
4. Select the **Conventional** and **GNSS** styles you want to reference for the integrated style. Tap **Accept**.
5. In the **Prism to antenna offset** field, tap  and select the prism type. The **Prism to antenna offset** field is populated with the correct offset value for the selected prism.

**NOTE** – If an incorrect antenna measurement method is set, the incorrect offset is applied to the GNSS antenna heights. Make sure the correct position is selected in the **Measured to** field for the antenna in the **Rover options** form of the GNSS survey style referenced by the integrated survey style.

**TIP** – To change the GNSS antenna height during an integrated survey you must change the current target height. See [To change the antenna or prism height during an integrated survey, page 424](#).

6. When surveying a road using the Roads software, the **Precise elevation** option is available. To combine the GNSS horizontal position with the elevation from a conventional setup, enable

**Precise elevation.**

When using precise elevation, the robotic total station is typically set up in a remote location with good visibility and safe from machinery. The elevation is determined by one or more

**Station elevation** measurements to point(s) with a known elevation. You can set up the robotic total station on a known control point, but this is not required.

7. Tap **Accept**.

8. Tap **Store**.

Prism to antenna offset values for standard prisms

For Spectra Geospatial receivers, the offset is from the center of the prism to the bottom of the **antenna mount**.

Prism type	Offset value
Spectra Geospatial 360°	0.034 m
Spectra Precision 360°	0.057 m

## To start and end an integrated survey

### To start the integrated survey

There are a number of ways to start an integrated survey. Use the method that best suits the way you work:

- Start a conventional survey and then start a GNSS survey at a later time.
- Start a GNSS survey and then start a conventional survey at a later time.
- Start an integrated survey. This starts a conventional survey and a GNSS survey at the same time.

You must have create an [integrated survey style](#) before you can start an integrated survey.

To start an integrated survey, tap  and select **Measure** or **Stakeout** and then select **<integrated survey style name>**.

**NOTE** - Only the conventional and GNSS survey styles that are referenced in the integrated survey style are available in the integrated survey.

## To end the integrated survey

You can end each survey individually, or select **End integrated survey** to end the GNSS survey and the conventional survey at the same time.

## To start an integrated survey using a station elevation setup

**NOTE** – The station elevation setup for an integrated survey is available only when starting a survey in the Roads software. For other station setup types, refer to the **Conventional survey setup** section of the Spectra Geospatial Origin Help.

1. From Roads, select **Survey / <integrated style name> / Station elevation**.
2. Set the [corrections](#) associated with the instrument.  
  
If the **Corrections** form does not appear, tap **Options** from the **Station setup** screen to set the corrections. To make the **Corrections** form appear on startup, select the **Show corrections on startup** option.
3. Tap **Accept**.
4. If required, enter the Instrument point name, Code, and Instrument height. If you are set up in an arbitrary location, accept the default point name and 0.000 instrument height.
5. Tap **Accept**.
6. Enter the point name, code, and target details for the point with the known elevation. Tap **Measure**. Once the measurement is stored, the **Point residuals** appear.  
  
**TIP** – You can use the pop-up arrow to select a point from a list, or key in a point. The point needs only a name and an elevation – horizontal coordinates are not required.
7. From the **Point residuals** screen, tap one of the following softkeys:
  - **+ Point**, to observe additional known points
  - **Details**, to view or edit point details
  - **Use**, to enable or disable a point
8. To view the station elevation result, tap **Results** in the **Point residuals** screen. To accept the result, tap **Store**.

The RTK survey starts. Once the RTK survey has initialized, you can begin to stake out using Precise elevation.

During a precise elevation road stakeout survey, the horizontal navigation is provided by the RTK survey, and the elevation is provided by the robotic survey. When a measurement is initiated, both a GNSS measurement and a conventional measurement are started at the same time. Separate GNSS and conventional measurements are stored in the job database, along with a grid coordinate that combines the results.

**NOTE** – *If the robotic total station cannot measure to the target, the cut\fill and vertical distance values appear as "?".*

## To switch between instruments

In an integrated survey, the controller is connected to both devices at the same time. This makes switching between instruments very quick.

To switch from one instrument to another, do one of the following:

- Tap the status line in the status bar
- Select **Measure / Switch to <survey style type>**
- Tap **Switch to** and then select **Switch to <survey style type>**
- Configure one of the controller function keys to **Switch to TS/GNSS** and then press that key. See [Favorite screens and functions, page 24](#).

In an integrated survey, identify the instrument that is currently 'active' by looking at the Status bar or the Status line.

If you are using a GNSS receiver with a built-in tilt sensor or an active target, the **eBubble** can be displayed, but for all conventional measurements **Tilt auto-measure** is not supported and no tilt warnings will be issued.

There are some Origin screens where you cannot switch instruments, for example **Continuous topo**.

### Measure topo / Measure points

If you switch instruments during an integrated survey when you are using Measure topo (conventional), the software automatically switches you to the Measure points (GNSS) screen (and vice versa).

The point name defaults to the next available name.

The code defaults to the last stored code.

Switch instruments before you change the point name and code. If you enter a point name or code before switching instruments, they will not be the default after the switch.

### Measure codes

When you switch instruments, the active instrument is used for the next observation.

### Continuous topo

Only one Continuous topo survey is possible at one time.

You cannot switch the instrument used in Continuous topo while Continuous topo is running.

To change the instrument that is being used in Continuous topo, tap **Esc** to exit Continuous topo and then restart Continuous topo.

You can switch instruments if the Continuous topo screen is open but running in the background. If you switch instruments when the Continuous topo screen is running in the background, and you later make the Continuous topo screen the active screen, the software automatically switches to the instrument with which you started Continuous topo.

### Stakeout

When you switch instruments, the graphical stakeout display changes.

If you switch instruments when the Stakeout graphics screen is running in the background, and you later make the Stakeout graphics screen the active screen, the software automatically switches to the instrument you last used.

If you switch instruments and a vertical offset to a DTM is specified in the survey style, the vertical offset from the survey style that was last added to the job is used (unless you manually change the vertical offset in the **Offset to DTM (Vertical)** field of the map settings screen or by tapping **Options** in a stakeout screen).

## To change the antenna or prism height during an integrated survey

To change the GNSS antenna height during an integrated survey you must change the current target height. The GNSS antenna height is computed automatically using the **Prism to antenna offset** configured in the IS style.

1. Make sure you have selected the correct prism type. In the **Prism to antenna offset** field, tap ► and select the prism type. The **Prism to antenna offset** field is automatically populated with the correct offset value for the selected prism.

**NOTE** – If an incorrect antenna measurement method is set, the incorrect offset is applied to the GNSS antenna heights. Make sure the correct position is selected in the **Measured to** field for the



*antenna in the **Rover options** form of the GNSS survey style referenced by the integrated survey style.*

2. Tap the target icon in the status bar and select the appropriate target.
3. Enter the **Target height** (the height to the center of the prism).

The updated height is not displayed in the status bar until the target form is closed.

4. To see the entered target height, the prism to antenna offset configured in the survey style, and computed antenna height, tap **Antenna**.
5. Tap **Accept**.

## Additional survey equipment

Refer to the topics in this section if you are using additional equipment for your survey.

### Laser rangefinders

The configuration for each laser that is supported by Origin is detailed below. To configure a Bluetooth wireless connection to the laser rangefinder see [Bluetooth connections, page 433](#).

**NOTE** – *Origin may support other models of laser rangefinder than the ones listed here, as the protocols used by the manufacturer are often the same or very similar between models.*

#### **Trimble LaserAce 1000**

There is no Bluetooth configuration on the LaserAce 1000, it is always enabled.

When the Trimble LaserAce 1000 is detected during the scan for Bluetooth devices, an authentication request dialog appears. You must enter the PIN number set in the laser rangefinder (default PIN = 1234).

#### **Bosche DLE 150 or Bosch GLM 50c**

When the laser rangefinder is detected, an authentication request dialog appears. You must enter the PIN number set in the laser rangefinder.

#### **LTI Criterion 300 or LTI Criterion 400**

From the main menu, press the down arrow or up arrow key until the *Survey* menu appears and then tap *Enter*. Select *Basic measurements* and tap *Enter*. A screen showing the fields *HD* and *AZ* appears.

#### **LTI Impulse**

Set up the laser to operate in CR 400D format. Make sure that a small "d" is displayed on the screen. (If necessary, press the **Fire2** button on the laser).

#### **LTI TruPulse 200B or LTI TruPulse 360B**

Set the TruPulse mode to either **Slope Distance**, **Vertical Distance**, or **Horizontal Distance**.

#### **Laser Atlanta Advantage**

Set the *Range/Mode* option to *Standard (Averaged)* and the *Serial/Format* option to *Trimble Pro XL*.

Set *Serial / Remote / Trigger Character* to 7 (37h). (The remote trigger works only when connected via a cable, not when using Bluetooth wireless technology.)

Set *Fire Time* to the delay required (not zero or infinity).

Set *Serial T-Mode* to *Off*.

### **LaserCraft Contour XLR**

Set the LaserCraft mode in the laser. If you connect through Bluetooth wireless technology, you also need to change the baud rate setting on the laser rangefinder to 4800.

### **Leica Disto Memo or Leica Disto Pro**

Set the unit to meters or feet, not feet and inches.

### **Leica Disto Plus**

You must enable Bluetooth wireless technology on the Leica Disto Plus before you run a Bluetooth scan. To do this, set *System / Power / Bluetooth* to *On*.

If automeasure is switched off:

1. To take the measurement, press the **Dist** key on the laser rangefinder.
2. Press the **[2nd]** key.
3. To transfer the measurement to the controller, press one of the eight direction arrow keys.

### **MDL Generation II**

No special settings are required.

### **MDL LaserAce**

Set the *Data record* format to *Mode 1*. When you use the angle encoder, set the magnetic declination to zero in the [Cogo settings, page 99](#) screen of the Origin software. The angle encoder in the MDL LaserAce laser corrects for the magnetic declination.

Set the baud rate to 4800.

There is no Bluetooth wireless technology configuration on the MDL LaserAce, it is always enabled.

When the MDL LaserAce is detected during the scan for Bluetooth devices, an authentication request dialog appears. You must enter the PIN number set in the laser rangefinder (default PIN = 1234).

### **To configure laser rangefinder settings in the survey style**

1. Tap  and select **Settings / Survey styles**. Select the required survey style. Tap **Edit**.
2. Select **Laser rangefinder**.
3. Select one of the instruments in the **Type** field.
4. If necessary, configure the **Controller port** and **Baud rate** fields.

The default value in the **Baud rate** field is the manufacturer's recommended setting. If the laser is a model with which the Origin software can automatically take a measurement when you tap **Measure**, select the **Auto measure** check box.

5. If required, select the **Auto store** point check box.
6. If the **Low quality targets** check box is available, clear the check box to reject measurements that are flagged by the laser rangefinder as low quality. When this happens you will need to take another measurement.
7. Tap **Enter**. The precision fields contain the manufacturer's precision values for the laser. They are for information only.

**TIP** – Laser measurements can be displayed as vertical angles measured from the zenith or inclinations measured from horizontal. Select a display option in the **Laser VA display** field of the **Units** screen. See [Units](#).

#### To measure points using a laser rangefinder

Before measuring distances with the laser rangefinder, connect it to the controller and configure the laser rangefinder settings in the laser and in the survey style.

**TIP** – Measuring distances using a laser rangefinder is especially useful when entering the offset when measuring a point, computing a point, or using the taped distances function to measure the points defining a rectangular shape. To insert a distance into a **Distance**, **H.Distance** or an **Offset** field, tap ► next to the **Laser** field and then measure the distance with the laser.

To measure points using a laser range finder:

1. Tap ☰ and select **Measure**.
2. Tap **Measure laser points**.
3. Enter the point name and a code for the point.
4. Select the **Start point** you are measuring the laser point from, or measure a new point using the connected GNSS receiver.

To measure a new point:

- a. Tap ► next to the **Start point** field.
- b. Enter the details for the point and then tap **Measure**.

c. Tap **Store**.

The software returns to the **Measure laser points** screen with the new point selected in the **Start point** field.

5. Enter the laser height and the target height.

***NOTE** – Allow the laser to settle for a few seconds before you take a measurement with it.*

6. Tap **Measure**.

7. Use the laser rangefinder to measure the distance to the target.

The details for the measurement appear in the **Measure laser points** screen.

If the software receives only a distance measurement from the laser, another screen is displayed with the measured distance in a **Slope distance** field. Enter a vertical angle if the measured distance is not horizontal.

8. Tap **Store**.

***NOTE** – If you are using a laser without a compass, you must key in a magnetic azimuth before the software can store the point. If you enter a value for magnetic declination in the laser, make sure **Magnetic declination** field in the **Cogo settings** screen is set to zero.*

## Echo sounder instruments

An ESD file for each echo sounder supported as standard is provided in the **C:\ProgramData\Spectra Geospatial Data\System Files** folder. To edit the ESD file, edit the file in a text editor. The name of the ESD file appears in the **Type** field in the **Echo Sounder** screen.

Origin supports as standard the following models of bathymetric echo sounders:

- **CeeStar Basic High Freq**

CeeStar Dual Frequency echosounders, BASIC output format, when the High Frequency depth is to be stored. The unit must be set to output 'prefixes' and not 'commas' in the output data Menu / Advanced / Prefix / Comma outfm set to [Use prefix].

- **CeeStar Basic Low Freq**

CeeStar Dual Frequency echosounders, BASIC output format, when the Low Frequency depth is to be stored. The unit must be set to output 'prefixes' and not 'commas' in the output data Menu

/ Advanced / Prefix / Comma outfm set to [Use prefix].

- **NMEA SDDBT device**

Any generic echosounder device that can output the NMEA DBT (Depth Below Transducer) sentence. The "talker ID" must send the standard "SD" identifier (so that output lines all begin with "\$SDDBT,..". Origin will accept the data in feet, meters, or fathoms and will convert values as appropriate.

- **SonarMite**

Any SonarMite device. The unit will be switched into 'Engineering mode' (output format 0) and other settings may be adjusted by Origin.

**NOTE** - When using an echo sounder to record depths that equal zero, you need to add the `allowZero="True"` flag immediately after the `isDepth="True"` flag. For example: "`<Field name... isDepth="True" allowZero="True" />`"

#### NMEA strings for echo sounders

Echo sounders may output one of several NMEA 0183 sentences. The most common sentences are described below for reference.

#### **NMEA DBT - Depth Below Transducer**

The NMEA DBT sentence reports water depth referenced to the transducer's position. The depth value is expressed in feet, meters, and fathoms.

For example: `$xxDBT,DATA_FEET,f,DATA_METRES,M,DATA_FATHOMS,F*hh<CR><LF>`

#### **NMEA DBS - Depth Below Surface**

The NMEA DBS sentence reports water depth referenced to the surface. The depth value is expressed in feet, meters, and fathoms.

For example: `$xxDBS,DATA_FEET,f,DATA_METRES,M,DATA_FATHOMS,F*hh<CR><LF>`

#### To add support for another model of echo sounder

The Origin software uses XML Echosounder protocol description (\*.esd) files and so may support bathymetric echo sounders that are not supported as standard, provided that their communications protocols are similar to the protocols currently supported. To do this, use one of the ESD files provided with the software and use it as a template. You will need to find out the format for your echo sounder and modify the ESD file accordingly.

### To configure echo sounder settings in the survey style

1. Tap  and select **Settings / Survey styles / <Style name>**.
2. Tap **Echo sounder**.
3. Select an [instrument](#) from the **Type** field.
4. Configure the **Controller port**:
  - If you set the **Controller port** to Bluetooth, you must configure the echo sounder [Bluetooth](#) settings.
  - If you set the **Controller port** to COM1 or COM2, you must configure the port settings.
5. If required, enter the **Latency** value.

The latency caters for echo sounders where the depth is received by the controller after the position. The Origin software uses the latency to match and store the depth when it is received with continuous topo points that were saved previously.

---

 **CAUTION** – There are many factors involved in correctly pairing positions with accurate depths. These include sound velocity – which varies with water temperature and salinity, hardware processing time, and the speed at which the boat is moving. Make sure that you use the appropriate techniques to achieve the required results.

---

6. If required, enter the **Draft** value.

**NOTE** – The **Draft** affects how the antenna height is measured. If the **Draft** is 0.00 then the antenna height is the distance from the transducer to the antenna. If a **Draft** is specified, then the antenna height is the distance from the transducer to the antenna, minus the draft.

7. Tap **Accept**.
8. Tap **Store**.

### To store depths using an echo sounder

1. Connect the echo sounder to the controller using a cable or Bluetooth.
2. Configure the **Echo sounder** settings in the survey style.

3. To store depths with measured points, use the continuous topo method for your survey type.  
The depth is displayed in the **Continuous topo** screen and in the map. If you have configured a **Latency** value in the survey style, the continuous topo points are initially stored without depths and later updated. When a latency has been configured, the depth that is displayed is an indicator that depths are being received but it may not be the depth that is stored with the point name that is displayed at the same time.
4. To change **Latency** and **Draft** values, tap **Options**. For more information, see [To configure echo sounder settings in the survey style, page 431](#).
5. To disable storing depths with continuous topo points during the survey, tap **Options** and then clear the **Use echo sounder** check box.

### To generate reports that include depths

The elevations of continuous topo points stored in Origin do not have the depth applied to them. Use **Export custom format** files to generate reports with depths applied.

The following report stylesheets are available for download:

- **Comma Delimited with elevation and depths.xsl**
- **Comma Delimited with depth applied.xsl**

To download these stylesheets, go to [Spectra Geospatial Origin Downloads page](#) and click **Style Sheets / General Survey Style Sheets** and then select the appropriate report link.

**NOTE** - If a Sonarmite instrument is connected, Origin configures it to use the correct output format and mode. For an instrument from another manufacturer, you must manually configure it to use the correct output format.

## Connections

Use the **Connections** screen to configure connections to other devices.

To view the **Connections** screen, tap  and select **Settings/ Connections**.

Select the appropriate tab:

- [Bluetooth](#) to configure a Bluetooth connection to an instrument, GNSS receiver, or other device.
- [Radio settings](#) to configure a radio connection to a conventional instrument.



- [Auto-connect](#) to configure the instruments or receivers that the controller will automatically connect to.
- [GNSS contacts](#) to manage GNSS contacts. GNSS contacts are used to contain the information needed to contact a real-time correction source to obtain real-time corrections for a GNSS survey.
- [Auxiliary GPS](#) to configure auxiliary GPS from a GPS device integrated into the controller or third-party GPS devices connected via Bluetooth. Auxiliary GPS can be used during a conventional survey for GPS search, navigating to a point, and to display the position in the map.

**TIP** – To configure how the controller connects to the Internet, select the **GNSS contacts** tab and then tap the **Internet Setup** softkey at the bottom of the screen. See [Internet setup](#).

## Bluetooth connections

The steps for connecting the controller to another device using Bluetooth wireless technology are outlined below.

### Devices you can connect

**NOTE** – *The options in this screen depend on your Origin software license.*

As long as your device supports Bluetooth, you can connect the controller to any:

- Spectra Geospatial GNSS receiver
- Spectra Geospatial conventional instrument
- SPDL Radio Bridge/EDB10 Data Bridge
- [auxiliary GPS receiver](#)
- [laser rangefinder](#)
- [echo sounder](#)
- another controller
- external radio

You can also connect the controller to a mobile phone or external modem and use the connected device to connect to the Internet. To create those connections, see [Internet connection setup, page 439](#).

### Enable Bluetooth on the device

To enable the controller to find the device when it scans for nearby Bluetooth devices, make sure Bluetooth is enabled on the device and the discoverable setting is enabled. For more information, refer to the documentation provided with your device.

When using a SPDL Radio Bridge, press the Radio button for **2** seconds to make it **discoverable**. The blue and red LEDs will blink, indicating the radio is ready to be paired with. If you press and hold the radio button for longer than 10 seconds then **all** stored Bluetooth pairings in the SPDL Radio Bridge are cleared. You will need to recreate any Bluetooth pairings between the SPDL Radio Bridge and your controller(s).

### To enable Bluetooth on the controller

- If the controller is a **Windows device**:
  - a. Swipe in from the right to display the Windows **Action Center** panel.
  - b. If the **Bluetooth connections** tile is gray, tap the tile to enable Bluetooth. The tile changes to blue.
- If the controller is an **Android device**:
  - a. Swipe down from the notifications area at the top of the screen.
  - b. If required, tap the icon to expand the settings area and then swipe right to view page 2.
  - c. If the Bluetooth icon is gray, tap the icon to enable Bluetooth.

**NOTE** – *If you are connecting a controller to another controller, you must enable Bluetooth on both controllers.*

### To pair with and connect to a Bluetooth device

**NOTE** – *If you are connecting a controller to another controller, complete these steps on **one** controller.*

1. Tap  and select **Settings / Connections**. Select the **Bluetooth** tab.

The Bluetooth tab shows a list of device types. For each option you can select from the list of paired Bluetooth devices. If there are no paired devices, the software opens the **Bluetooth search** screen.

2. Tap **Search**. The **Bluetooth search** screen shows a list of **Discovered devices** and **Paired devices**.

**NOTE** – A device cannot respond to a scan if the Bluetooth radio is already in use. You must end the existing Bluetooth connection on the device and restart the scan. To restart the scan, tap **Clear**. The list of **Discovered devices** clears and the scan restarts automatically.

3. Select the device to connect to. Tap **Pair**.
4. If the controller is not already paired with the device, you are prompted to enter the PIN. You may also need to enter the same PIN on the device.

Spectra Geospatial receivers do not require a PIN by default. For PINs for other devices, refer to the documentation provided with the device.

**TIP** – The **Pair with** pop-up dialog is provided by the operating system. If additional settings such as the **PIN contains letters or symbols** check box or the **Enable access to your contacts and call history** check box appear you can leave the check boxes unchecked.

5. Tap **OK**.
6. The Origin software displays a pop-up dialog for the newly paired device. From the device type list, select how you want to use the Bluetooth device. Tap **Accept**.

**NOTE** – If you paired with a cellular modem, the controller now appears as a paired device on the cellular modem.

7. In the **Bluetooth** tab, tap **Accept**.

#### To connect to a paired device

1. Tap **☰** and select **Settings / Connections**. Select the **Bluetooth** tab.
2. Select the device to connect to from the appropriate device type field and then tap **Accept**.  
If Auto-connect is enabled, the Origin software connects to the device within a few seconds. Otherwise, start a survey to connect to the device.
3. Tap **Accept**.

**TIP** – The controller automatically connects to the selected device the next time you turn on both devices.

**NOTE** – If you attempt to reconnect to a Spectra Geospatial GNSS receiver and the software shows **Bluetooth error 10051**, then the GNSS firmware on the receiver has been updated and the settings have been restored to the default settings. You must unpair from the device and then re-pair with the device.

To unpair from a device, in the **Bluetooth** tab tap **Search** to open the **Bluetooth search** screen. Select the paired device and then tap **Config** to open the operating system Bluetooth devices screen, where you can manage paired devices.

## Radio connections

To connect the controller to the instrument using a radio, you must configure the instrument radio settings to the same values as used on the controller.

**NOTE** – In some countries, you must obtain a radio license before using your system on a working site. Make sure that you check the regulations for your country.

### To use the controller's internal radio

1. To configure the instrument radio settings, connect the controller to the instrument using a cable or Bluetooth. Alternatively, configure radio settings using the **Face 2** display on the instrument.
2. Tap  and select **Settings / Connections**. Select the **Radio settings** tab.
3. To avoid conflicting with another user, enter a unique radio channel and network ID.
4. Tap **Accept**.
5. If the controller is already connected to the instrument, the radio settings in the instrument are automatically synchronized to match the controller settings. To start the robotic connection, tap the instrument icon in the status bar and then tap **Start robotic** or tap **Connections** and then tap **Switch to LR radio**.
6. If the controller is not yet connected to the instrument:
  - a. Use the **Face 2** display to navigate to the **Radio settings** and enter the same radio channel and network ID as you entered on the controller.
  - b. On the instrument, select **Exit** from the **Setup** menu to return to the **Waiting for connection** menu.

**NOTE** – Because Origin cannot communicate with the total station when the instrument's onboard software is in use, the instrument must be in the **Waiting for connection** state.

The controller automatically connects to the instrument when both devices are on and within range.

When the instrument is suspended ready for robotic operation, it switches off to conserve power. The internal radio remains switched on so that the rover radio can communicate with the instrument.

### To use an external radio

To obtain a robotic connection to the instrument through an external radio you must reconfigure the radio port setting on the controller:

1. Connect the controller to the external radio using Bluetooth or a serial cable.

**NOTE** – If the radio is a SPDL Radio Bridge or EDB10 Data Bridge, you must use Bluetooth.

2. Tap  and select **Settings / Connections**. Select the **Radio settings** tab.
3. Tap **Options**.
4. Select the controller port that the radio is connected to. If you are using a Bluetooth connection, select **Bluetooth**.
5. Tap **Accept**.
6. Configure the **Radio channel** and **Network ID** to the same values as those set on the instrument.
7. Tap **Accept**.

### Auto-connect settings

When auto-connect is enabled, the Origin software automatically attempts to connect to the GNSS receiver or conventional instrument connected to the controller as soon as you start the software. For a list of supported instruments and receivers, see [Supported equipment, page 6](#).

When the software is attempting to connect to a device, the auto-connect icon in the status bar flashes. If the software is configured to automatically connect to different types of devices, the status bar shows a different icon as the software attempts to connect to each type of device.

**TIP** – You do not have to wait for the software to auto-connect. To force the software to connect to the device connected to the controller at any time, select the survey style and start the survey.

**NOTE** – If the auto-connect icon displays multiple icons and a red x , then auto-connect has been disabled for all device types.

### To configure auto-connect

1. To open the **Auto-connect** settings:
  - Tap the auto-connect icon in the status bar **before** you connect to a device.
  - Tap  and select **Settings / Connections**. Select the **Auto-connect** tab.
2. To speed up the automatic connection time, clear the check boxes in the **Auto-connect** tab to disable auto-connect for devices you do not usually connect to.

**NOTE** – The options in this screen depend on your Origin software license.

3. If you are connecting to the instrument using any connection method except a cable, select the appropriate tab in the **Connections** screen for your connection method and configure the connection.

### Using auto-connect with an instrument

When you use **Instrument functions** to disconnect from the total station, auto-connect is temporarily disabled.

To re-enable auto-connect, tap the auto-connect icon in the status bar. When auto-connect has been temporarily disabled, a single tap re-enables auto-connect, and a second tap is required to display the **Auto-connect** tab of the **Connections** screen.

**NOTE** – To connect to a third-party instrument, you must force a connection by starting the survey. When using third-party instruments, **disable** auto-connect. Some commands used by auto-connect can interfere with the communication of third-party instruments.

### Using auto-connect with a receiver

If the software is configured for **Rover mode** or **Base mode**, the software attempts to auto-connect to the receiver configured in the **Bluetooth** tab of the **Connections** screen:

- If the software is in **Rover mode**, it attempts to connect to the receiver configured in the **Connect to GNSS rover** field.
- If the software is in **Base mode**, it attempts to connect to the receiver configured in the **Connect to GNSS base** field.

To view or set the current mode, tap  and select **Receiver settings / GNSS functions**.

If there is no receiver configured in the appropriate field in the **Bluetooth** tab, then the software attempts to connect to the GNSS receiver on the serial port of the controller; and if a receiver is detected it assumes it is the receiver for the current mode.

## GNSS contact settings

A GNSS contact is contains the information needed to contact a real-time correction source to obtain real-time corrections.

See [To create a GNSS contact for a rover Internet data link, page 371](#).

When you start an RTK survey that uses an Internet data link, the Origin software automatically connects to the real-time correction source using the GNSS contact configured in the survey style. If you experience connection issues, you can check the connection to the GNSS contact. See [To manually connect to the GNSS contact, page 381](#).

## Internet connection setup

The most common ways to connect to the Internet are to use mobile broadband on the controller or to use the controller's Wi-Fi radio. How to connect to the Internet using these options are described below.

Alternatively, if the SIM card you want to use is in another device, you can connect the controller to the other device and use that device to connect to the Internet. See:

- [Internet setup using a separate smartphone, page 441](#)
- [Internet connection using another device, page 443](#)

**NOTE** - To use the Internet connection for a [real-time Internet data link](#), you must also create a GNSS contact that specifies the internet address from which to obtain the correction data. See [To create a GNSS contact for a rover Internet data link, page 371](#).

### To use mobile broadband on the controller

To use the cellular modem and the SIM card in the controller to connect to a 3G or 4G mobile broadband network, **make sure a SIM card is inserted** in the controller. For information on how to do this, refer to the documentation for your controller.

**NOTE** – *If the controller is an Android device and there is a SIM card inserted, the device automatically connects to the cellular network. If more than one SIM card is inserted in the controller, navigate to the operating system settings screen and search for **SIM cards** and then select your preferred SIM card.*

#### **If the controller is a Windows device:**

1. Swipe in from the right to display the Windows **Action Center** panel.
2. If the **Cellular** tile is gray, tap the tile to enable it. The tile changes to blue.
3. To configure options for the cellular connection, tap and hold the **Cellular** tile and select **Go to Settings**.
  - a. To automatically connect to the cellular network whenever the controller is in range, select **Let Windows manage this connection**.
  - b. Select whether Windows can automatically switch to the cellular network if the Wi-Fi connection is poor.

For more information, refer to the documentation for your controller.

### To connect the controller to a Wi-Fi network

To use the Wi-Fi radio in the controller to connect to a Wi-Fi network:

1. Enable Wi-Fi on the controller.
  - If the controller is a **Windows device**:
    - a. Swipe in from the right to display the Windows **Action Center** panel.
    - b. If the **Network** tile  is gray, tap the tile to enable it. The tile changes to blue.
    - c. Select the network from the list.



- If the controller is an **Android device**:
  - a. Swipe down from the notifications area at the top of the screen.
  - b. If the Wi-Fi icon is gray, tap the icon to enable it and then set the **Wi-Fi** switch to **On**.
  - c. Select the network from the list.
- 2. If required, enter the appropriate login details.
- 3. Tap **Connect**.
- 4. Open your Internet browser and enter a URL to confirm the controller can connect to the Internet.
- 5. To use this Internet connection for an Internet RTK data link, when configuring the GNSS contact in Origin, tap in the **Network connection** field and select **Controller Internet**. See [To create a GNSS contact for a rover Internet data link, page 371](#).

### Internet setup using a separate smartphone

You can connect the controller to the Internet using a separate smartphone. Connect the smartphone to the controller using a Wi-Fi or Bluetooth connection. The controller then uses the smartphone's connection to the 3G or 4G mobile broadband network to connect to the Internet.



In general, Wi-Fi connections have faster data connections but use more battery power on both devices than Bluetooth connections.

### To connect to the smartphone using Wi-Fi

1. On the phone, enable the **Mobile hotspot** or **Portable hotspot** setting.

This turns off Wi-Fi on your phone so that the phone is now in **Access Point** mode. A notification shows the name of the created AP and the required passkey.



**TIP** – To locate this setting on your phone, open the main **Settings** app and enter **hotspot** in the **Search** field.

2. On the controller, press the Windows key  to display the Windows taskbar and tap the **Wireless network icon** .

- a. If the **Wi-Fi** tile is gray, tap it to enable it. The tile changes to blue.
  - b. In the list of Wi-Fi networks, select the name of your phone's Access Point and enter the required passkey.
  - c. Tap **Connect**.
3. Open your Internet browser and enter a URL to confirm the controller can connect to the Internet.
  4. To use this Internet connection for an Internet RTK data link, when configuring the GNSS contact in Origin, tap in the **Network connection** field and select **Controller Internet**. See [To create a GNSS contact for a rover Internet data link, page 371](#).
  5. To disconnect the controller from your smartphone, tap the **Wireless network icon**  in the Windows taskbar, select the phone access point and tap **Disconnect**.

**TIP** – The next time you want to use the phone's Internet connection, re-enable the **Mobile hotspot** or **Portable hotspot** setting on the phone and then on the controller select the wireless network and tap **Connect**.

#### To connect to the smartphone using Bluetooth

1. Pair the smartphone with the controller. To do this:
  - a. Enable Bluetooth on the phone.
  - b. On the controller, press the Windows key  to display the Windows taskbar and tap the system tray arrow. Tap the **Bluetooth** icon  and select **Add a Bluetooth Device**. Make sure **Bluetooth** is set to **On**.

**TIP** – The name of the controller is shown just below the **Bluetooth On** switch.
  - c. On the controller, tap **Add Bluetooth or other device**. Select **Bluetooth** as the device type. In the list of devices on the controller, select the name of your phone.
  - d. When prompted, tap **OK** or **Connect** on each device to confirm the passkey is correct.

**NOTE** – If there is a long list of Bluetooth devices on the controller, swipe down (scroll) to see the passkey confirmation prompt and buttons. The prompt times out after a few seconds, so if you miss it, tap **Cancel** and repeat steps (c) and (d).

- e. On the controller, tap **Done**.
2. On the phone, enable the **Bluetooth tethering** or **Internet tethering** setting to allow your phone's Internet connection to be shared with another device.

**TIP** – To locate this setting on your phone, open the main **Settings** app and enter **tethering** in the **Search** field.

3. To use the phone's Internet connection on the controller:
  - a. Press the Windows key  to display the Windows taskbar and tap the arrow to display the system tray. Tap the **Bluetooth** icon and select **Join a Personal Area Network**.  
The Windows **Devices and Printers** window opens. Wait for a moment for the connected phone to appear.
  - b. Tap the phone and from the options at the top of the window, select **Connect using / Access point**.

4. Open your Internet browser and enter a URL to confirm the controller can connect to the Internet.
5. To use this Internet connection for an Internet RTK data link, when configuring the GNSS contact in Origin, tap in the **Network connection** field and select **Controller Internet**. See [To create a GNSS contact for a rover Internet data link, page 371](#).
6. To stop using the phone's Internet connection, return to the Windows **Devices and Printers** window, select the phone and tap **Disconnect from device network**.

**TIP** – The next time you want to use the phone's Internet connection, connect the devices using Bluetooth and then repeat the steps in step (3) above.

#### Internet connection using another device

**NOTE** – This feature is not supported if the controller is an Android device. To connect to the Internet you must use a Wi-Fi or cellular connection on the controller. See [Internet connection](#)



[setup, page 439.](#)

If you have another device such as a GNSS receiver or a mobile phone, you can connect the controller to the Internet through that device. This is especially useful for an RTK Internet data link if the SIM card you want to use is in the receiver or if you want to be able to use the Internet on the controller for other functions during the RTK survey.

**NOTE** – *To connect to the Internet through a receiver or a mobile phone:*

- *The modem in the device must support the Bluetooth DUN service.*
- *The receiver must be an SP85 receiver.*
- *Modems used with Origin must support Hayes compatible AT commands.*

To configure the connection:

1. Tap  and select **Settings / Connections**. Select the **GNSS contacts** tab.
2. Tap **New**. The **Edit GNSS contact** screen appears.
3. Enter the **GNSS contact name**.
4. In the **Network connection** field, tap  to open the **Network connection** screen.
5. Tap **Add**. The **Create new network connection** screen appears.
  - a. Enter a **Name** for the network connection.
  - b. If you have not yet connected the controller to the device, you can do it now:
    - i. Tap **Config**. The Windows **Bluetooth** settings screen opens.
    - ii. Make sure **Bluetooth** is set to **On**, and then tap **Add Bluetooth or other device**.
    - iii. Select **Bluetooth** as the device type. In the list of devices on the controller, select the name of your phone.
    - iv. When prompted, tap **OK** or **Connect** on each device to confirm the passkey is correct.
 

**NOTE** – *If there is a long list of Bluetooth devices on the controller, swipe down (scroll) to see the passkey confirmation prompt and buttons. The prompt times out after a few seconds, so if you miss it, tap **Cancel** and repeat steps (c) and (d).*
    - v. On the controller, tap **Done**.

- vi. Return to the **Create new network connection** screen and configure the connection settings for the connected modem
- c. In the **Bluetooth modem** field, select the device the controller is connected to.
- d. In the **APN** field, tap ► to choose the method for selecting the Access Point Name (APN) for the Internet service provider. This is the service provider that provided the SIM card in the device:
  - Choose **SIM default** to load the APN profile directly from the SIM card in the device.
  - Choose **Select Access Point Name (APN)** to select your **Location** and your **Provider and plan** from the APN wizard in Origin. Tap **Accept**.
- e. In the **Number to dial** field, enter \*99\*\*\*1#. The \*99\*\*\*1# is a standard access code for mobile Internet. If you are unable to connect using \*99\*\*\*1#, contact your mobile Internet provider.
- f. If required, enter a **Username** and **Password**. By default these fields are both set to **guest**
- g. Tap **Accept**.

***NOTE** - If a message appears warning that details of the Bluetooth DUN service for the connected device could not be resolved, then the device may not support Bluetooth DUN. Try connecting creating a connection to the phone using the steps for a [smartphone](#).*

6. In the **Network connection** screen:
  - a. If a PIN is required, enter the PIN in the **Modem pin** field.
  - b. Tap **Accept**.

7. Tap **Store**.

The network connection you just created is shown in the **Network connection** field in the **Edit GNSS Contact** screen.

8. Configure the **Corrections** settings for the GNSS contact as required. See [To configure correction settings, page 373](#).
9. Tap **Store**.

## Conventional survey measure methods

To measure points using data from the connected conventional instrument, complete the station setup and then tap  and select **Measure** and then select the measurement method to use:

- Use **Measure topo** to measure a topographic point.
- Use **Measure codes** to measure and code observations in one step.
- Use **Measure rounds** to measure multiple sets of observations.
- Use **Measure to surface** to calculate and store the closest distance from the measured point to the selected surface.
- Use **Measure points on a plane** to define a plane and then measure points relative to the plane.
- Use **Measure 3D axes** to measure a point relative to a 3D axis.
- Use **Continuous topo** to measure a line of points at a fixed interval.
- Use **Surface scanning** to define a surface and then scan points on the surface.

See also:

- [To measure points using a laser rangefinder, page 428](#)
- [To store depths using an echo sounder, page 431](#)
- [To measure a check point, page 455](#)
- [Construction points, page 216](#)

### To measure a topo point

To configure settings for points measured in a conventional survey, tap **Options** in the **Measure topo** form. (In portrait mode, swipe right to left along the row of softkeys to view the **Options** softkey.)

1. Tap  and select **Measure / Measure topo**.
2. Enter the **Point name** and **Code**. See [To select feature codes, page 485](#).

If the selected code has attributes, the **Attrib** softkey appears. Tap **Attrib** and fill out the attribute fields. See [To enter attribute values when measuring a point, page 487](#). Tap **Store**.

3. In the **Method** field, select a measurement method.
4. Enter a value in the **Target height** field. See [Target height, page 315](#).
5. Aim the instrument at the target, prism or, if using DR mode, at the object to be measured. To turn the instrument to the angle indicated on the screen, tap **Turn**.

6. Tap **Measure**.

If you did not select the **View before storage** check box, the point is stored automatically and the point name increments (based on the **Auto point step size** setting). The software stores the raw observations (HA, VA, and SD).

If you selected the **View before storage** check box in the survey style, information about the measurement appears on the screen. To view the available information, tap the arrow to the left.

7. Tap **Store**.

If you selected the **Auto average** option in the survey style, and you are measuring an observation to a duplicate point that is within the specified duplicate point tolerances, the observation and the computed average position (using all the available point positions), are automatically stored.

#### TIP –

- To search for the next available point name, tap **Find**. Enter the point name you want to start searching from (for example, 2000) and tap **Enter**. The software searches for the next available point name after 2000 and inserts it in the **Point name** field.
- When the instrument EDM is in tracking mode, you can turn the instrument to the next point and then tap **Read**. The last point is stored and a measurement is made to the next point.
- To add topo points to a CSV file, for example to create a list of control points, enable the **Add to CSV file** option in the job. See [Additional settings, page 108](#).
- When measuring a point in DR mode with a defined standard deviation, to accept the measurement before the standard deviation has been satisfied, tap **Enter**.

### To measure by averaging observations

In a conventional survey, increase the measurement precision by averaging a predefined number of observations.

1. Tap  and select **Measure / Measure topo**.
2. Enter the **Point name** and **Code**. See [To select feature codes, page 485](#).  
If the selected code has attributes, the **Attrib** softkey appears. Tap **Attrib** and fill out the attribute fields. See [To enter attribute values when measuring a point, page 487](#). Tap **Store**.
3. In the **Method** field, select **Averaged observations**.
4. To set the number of observations taken by the instrument, tap **Options**.
5. Enter a value in the **Target height** field. See [Target height, page 315](#).
6. Aim the instrument at the target, prism or, if using DR mode, at the object to be measured.
7. Tap **Measure**.

While the instrument is carrying out the measurements, standard deviations are displayed for the horizontal (HA) and vertical (VA) angles, and the slope distance (SD).

8. Tap **Store**.

#### TIP –

- To search for the next available point name, tap **Find**. Enter the point name you want to start searching from (for example, 2000) and tap **Enter**. The software searches for the next available point name after 2000 and inserts it in the **Point name** field.
- When measuring an **Averaged observation** tap **Enter** to accept the measurement before the required number of observations has been completed.

### To measure by angles only or angles and distance

In a conventional survey, you can measure a point using a horizontal and a vertical angle or by a horizontal angle only. Alternatively, measure a point by angles and a distance.

1. Tap  and select **Measure / Measure topo**.
2. Enter the **Point name** and, if required, the **Code**.
3. In the **Method** field, select **Angles only**, **H. Angle only** or **Angles and distance**.



4. In the **Target height** field, enter the height of the target.
5. To set the perspective from which objects are offset, tap **Options** and change the settings in the **Servo/Robotic** group box. For more information, see [Servo/Robotic, page 281](#).
6. When using the **Angles and distance** measurement method, tap **Dist** to measure and fix the horizontal distance, then turn the instrument. The horizontal distance will remain fixed but the horizontal and vertical angles will change.

**NOTE** – The distance reverts to ? if the **Target test** setting is enabled in the **Instrument settings** screen and the instrument is turned more than 30 cm from the target. See [Target test, page 334](#).

7. Tap **Measure**.
8. If you selected the **View before storage** check box in the survey style, the observation adjusted for the offset distance appears. Tap **Store**.

**NOTE** – Two angles only observations from two different known points can be 'averaged' to compute the coordinates of the intersection point. To average the observations, they must be stored with the same point name. When the **Duplicate point: Out of tolerance** message appears, select **Average**. Alternatively, average the observations using **Compute average**. Select the averaging method in the **Cogo settings** screen..

### To measure by angle offset

In a conventional survey, there are three angle offset methods that you can use to observe a point that is inaccessible:

- The **Angle offset** method holds the horizontal distance from the first observation, and combines this with the horizontal angle and vertical angle from the second observation to create an observation to the offset location.
- The **V.Angle offset** method holds the horizontal distance and horizontal angle from the first observation, and combines this with the vertical angle from the second observation to create an observation to the offset location.
- The **H.Angle offset** method holds the slope distance and vertical angle from the first observation, and combines this with the horizontal angle from the second observation to create an observation to the offset location.

All raw observables from the first and second observations are stored in the job file as HA, VA, and SD records and can be exported.

1. Tap  and select **Measure / Measure topo**.
2. Enter the **Point name** and, if required, the **Code**.
3. In the **Method** field, select **Angle offset, H. Angle Offset, or V. Angle Offset**.

When using the **H.Angle offset** measurement method, the target height from the first observation is applied to the horizontal angle offset observation.

When using **Angle offset** or **V.Angle offset** measurement methods you do not need to enter the **Target height**. The offset measurements are to the offset location and the target height is not used in any computations. To ensure that a target height is not applied to the observation, a target height of 0 (zero) is automatically stored to the software database.

4. If you are using Autolock technology, tap **Options** and select the **Autolock off for offsets** check box to automatically disable Autolock for the offset measurement and then re-enable it after the measurement.
5. Aim the instrument at the target, prism or, if using DR mode, at the object to be measured.
6. Tap **Measure**.  
The first observation is displayed.
7. Turn to the offset location and then tap **Measure**. The two observations are combined into one.
8. If you selected the **View before storage** check box in the survey style, the observation adjusted for the offset distance appears. Tap **Store**.

#### To measure by distance offset

In a conventional survey, use this observation method when a point is inaccessible but a horizontal distance from the target point to the object can be measured. Distance offset allows you to offset in one, two, or three distances in one step.

1. Tap  and select **Measure / Measure topo**.
2. Enter the **Point name** and, if required, the **Code**.
3. In the **Method** field, select **Distance offset**.

4. In the **Target height** field, enter the height of the target.
5. To set the perspective from which objects are offset, tap **Options** and change the settings in the **Servo/Robotic** group box. For more information, see [Servo/Robotic, page 281](#).

To preconfigure two values for the **L/R offset**, enter values in the **Custom L/R offset 1** and **Custom L/R offset 2** fields.

6. In the **L/R offset** field, enter the left or right offset from the target to the object, if applicable. If you have configured custom offsets in the **Options** screen, tap ► and select the offset.

**TIP** – To set all three offset values to 0, tap ► and select **Set offsets to 0**. If all three fields are set to 0 the measurement will be treated as an **Angles and distance** measurement. The **Set offsets to 0** option is also available from the **In/Out offset** and **V.Dist offset** fields.

7. Enter the **In/Out offset** from the target to the object, if applicable.
8. Enter the **V.Dist offset** from the target to the object, if applicable.
9. Tap **Measure**.
10. If you selected the **View before storage** check box in the survey style, the observation adjusted for the offset distance appears. Tap **Store**.

The software stores the adjusted horizontal angle, vertical angle, and slope distance in the point record, as well as an offset record with the offset measurement details.

The following figure shows an example where point 5 is measured with the **Offset & Stakeout directions** set to **Instrument perspective**:

- offset to the left (2) of the target (3)
- offset out (4) from the instrument station (1)
- offset vertically (6)

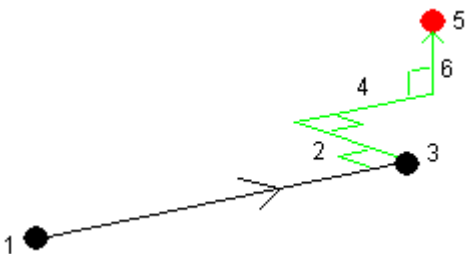

### To measure by dual-prism offset

In a conventional survey, use this measurement method to coordinate a point that cannot be observed directly with a pole in a plumb position.

**NOTE** – The use of a tiltable prism with the appropriate nodal offset will give accurate results regardless of the direction of pole tilt. Prisms that should not be tilted do not correct the vertical angle and slope distance for the difference between the optical center of the prism and the centerline of the pole.

1. As shown in the following diagram, space two prisms (A and B) apart on the range pole. The distance BC is known.

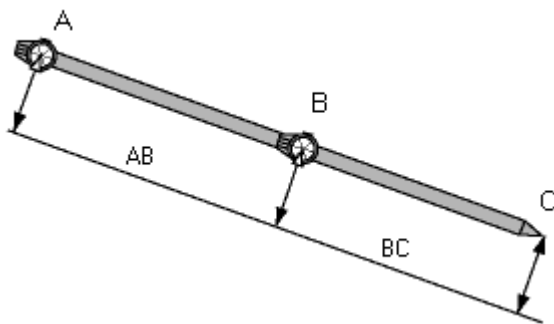

2. Tap  $\equiv$  and select **Measure** and then perform a station setup. See [Station setup, page 295](#).
3. Tap  $\equiv$  and select **Measure / Measure topo**.
4. Enter the **Point name** and, if required, the **Code**.
5. In the **Method** field, select **Dual-prism offset**.
6. Complete the fields as required.

**TIP** – Enter a suitable **Tolerance AB** to generate a warning if there is a difference between the keyed-in distance AB between the two prisms and the measured distance AB between the two prisms. Exceeding the tolerance could indicate that the entered distance AB is incorrect, or it could indicate pole movement between the measurement to prism A and the measurement to prism B.

7. Tap **Measure**. Take two measurements.

The software calculates the obscured position (C) and then stores it as a raw HA VA SD

observation.

All raw observations are stored in the job file and are available for export.

### To measure a circular object

In a conventional survey, use this measurement method to calculate the center point of a circular object, such as a water tank or silo.

1. Tap  $\equiv$  and select **Measure / Measure topo**.
2. Enter the **Point name** and, if required, the **Code**.
3. In the **Method** field, select **Circular object**.
4. To select the calculation method, tap **Options**. See [calculation methods](#).
5. If you are using a non-motorized total station and you selected the bisect tangent method, turn the total station to the half angle so that it can complete the measurements.

For motorized total stations using the bisect tangent method, or when using the center + tangent method, the instrument automatically takes the measurements.

### Calculation methods

When measuring a circular object, you can select one of the following calculation methods.

#### Bisect tangent method

The bisect tangent method measures an angles-only measurement to the visible edges of the left and right sides of the circular object and then measures a DR measurement to a point on the circumference of the circular object.

The software uses the three measurements to calculate the radius of the circular object. It adds the radius distance to the DR measurement and stores a raw HA VA SD observation to the center of the object.

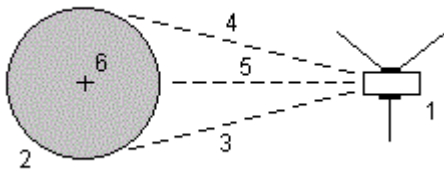

1

Total station

**2**

Circular object

**3 and 4**

Angle and distance measurements

**5**

DR measurement

**6**

Center of object

#### Center + tangent method

The center + tangent method measures an angle and distance measurement to the front center face of the circular object, and then observes an angles only measurement to the side of the circular object.

From these two measurements, the software calculates the center point of the circular object and stores it as a raw HA VA SD observation. It also calculates the radius and stores it with the observation.

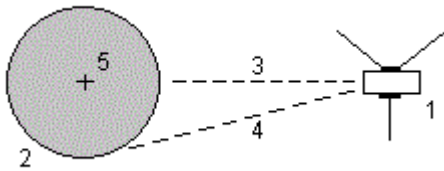

**1**

Total station

**2**

Circular object

**3**

Angle and distance measurement

**4**

Angles only measurement

**5**

Center of object

### To measure a remote object

In a conventional survey, if the instrument does not support DR mode, or if you cannot measure a distance, use this method to calculate the height and/or width of a remote object. See the following diagram.

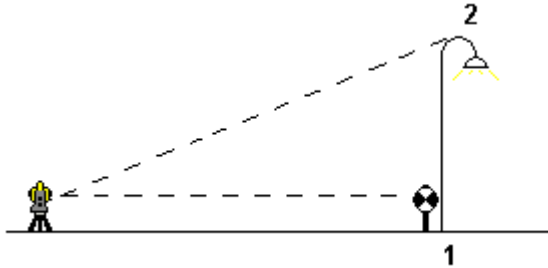

1. Tap  $\equiv$  and select **Measure / Measure topo**.
2. Enter the **Point name** and, if required, the **Code**.
3. In the **Method** field, select **Remote object**.
4. Measure an angle and distance to the bottom of the remote object (1).
5. Set the method as required.
6. Sight to the remote point (2).
7. Tap **Store**.
8. To make multiple remote object observations, repeat steps 6 and 7.

Using the first measurement and continuous HA VA angles, the Origin software calculates the position of the remote object, showing the width and elevation difference from the base point.

The observation to the base of the remote object is stored as an HA, VA, SD. The Remote point is stored as an HA, VA with a computed SD, including the object height and object width.

### To measure a check point

In a conventional survey, measure a check class point to check the station setup and make sure the instrument is oriented correctly.

1. To open the **Check shot** screen:
  - From the **Measure topo** screen, tap **Check**.
  - In the map, tap and hold the point to measure to and then select **Check shot**.

- From anywhere in the software, press **Ctrl + K**.

The **Check shot** screen appears, ready to take a check measurement to a general point.

**TIP** – To take a check measurement to a backsight point, tap **Chk BS** in the **Check shot** screen, or tap and hold in the map without selecting a point and then select **Check backsight**. The **Check backsight** screen appears.

2. Enter the name of the point to check.

If you are using a servo or robotic instrument, it turns to the point to be checked.

If the point is a backsight point, the backsight target is automatically selected. Make sure the details are correct.

3. Select a measurement method and enter the required information for the selected method.
4. Enter the height of the target.

When measuring to the notch on a [Spectra Geospatial traverse prism base](#), tap  and then select **S notch**.

5. Tap **Measure**.

If you selected **View before storage** in the **Topo point** settings screen, the check shot deltas are shown.

If the station setup is:

- the same as when you originally measured the point, the deltas are the difference in values between the original observation and the check observation. The deltas displayed are horizontal angle, vertical distance, horizontal distance, and slope distance.
- different from when you originally measured the point, the deltas are in terms of the best coordinates from the original point to the check point. The deltas displayed are azimuth, vertical distance, horizontal distance, and slope distance.

**NOTE** – If the point is out of tolerance, you can **Store as check**, or **Store and reorient**. Store and reorient will store another observation that will provide a new orientation for subsequent points measured in the current station setup. In a multiple backsight station setup (station setup plus



*or resection), a check backsight measurement checks the first backsight. Storing and reorienting effectively changes the multiple backsight station setup into a single station setup.*

6. Tap **Enter**. The point is stored with a classification of **Check**. See [Managing points with duplicate names, page 200](#).

## To measure rounds of observations

This topic describes how to measure multiple sets (rounds) of observations with a conventional instrument. You can measure one or rounds of observations, and also one or more sets of observations per point per round.

1. Tap  and select **Measure / Measure rounds**.
2. Tap **Options** to configure the rounds options. See [Station setup plus, resection, and rounds options, page 303](#).

Before you start measuring points, make sure that the **Face order** and **Sets per point** settings are correct. You cannot change these settings after you start measuring points.

3. Build the rounds list by observing each point to include in the round on the first face. Follow the same procedure as for measuring a topo point.

Make sure you enter the correct target height and prism height as you measure each point. You cannot change these values in subsequent rounds.

4. To start measuring rounds:
  - a. Tap **End face**.
  - b. If you are using a servo or robotic instrument to measure a known (coordinated) point, tap **Turn**. Alternatively, to automatically turn a servo instrument to the point, set the **Servo auto turn** field in the survey style to **HA & VA** or **HA only**.

**NOTE** – *When using servo or robotic instruments, check that the instrument has sighted the target accurately. When measuring a DR target with a Spectra Geospatial total station with automated rounds, the software pauses to allow you to sight to the target. You **must** manually sight and measure the point to continue.*

- c. When the end of the rounds list is reached, if points have been skipped the software prompts you to return to observe the points that were skipped during that round. The observations can be skipped again if required.

As you measure rounds, the software:

- Defaults to the correct point details for each observed point.
- Shows the current face observations, the number of the current set and the total number of sets to be measured (shown in brackets) and the number of the current round the total number of rounds to be measured (shown in brackets).

For example, "Face 1 (2/2) (1/3)" shows that the instrument is on face 1 of the second set of two sets and the first of three rounds.

- Directs you to change face when required. With a servo instrument, this happens automatically.
  - Automatically turns and measures when using Autolock technology, and **Automated rounds** is enabled.
5. When all observations are complete, the **Standard deviations** screen appears. To review the standard deviations of the observations and remove bad observations, see [Reviewing standard deviations after rounds, page 459](#).
  6. To save and exit rounds, tap **Close**. Tap **Yes** to confirm.

### Measuring rounds

During a **Station setup plus** or **Resection**, or when using the **Measure rounds** measurement method, you can measure multiple sets (rounds) of observations.

A round is a set of either:

- single face 1 observations
- matched face 1 and face 2 observations

Rounds can be used in a number of different ways depending on your equipment, the accessibility of points, and the procedures to observe the points, such as the order in which the observations are made.

### Building a rounds list

The **rounds list** contains the points used in the rounds observations.

The software automatically builds the rounds list as each point is added to a **Station setup plus** or **Resection**, or as you measure each point for the first time when using the **Measure rounds** measurement method.

The rounds list contains information about each point including point name, code, target height, prism constant, and target ID. You cannot alter the prism constant or the target height for subsequent rounds.

**NOTE** – *Because the Origin software uses the target height and prism constant values stored when building the rounds list, you must enter the correct target height and prism constant as each point is added to the rounds list.*

The maximum number of points in the rounds list when:

- Using the **Measure rounds** measurement method is 200
- During **Station setup plus** or **Resection** is 25.

To complete the rounds list, tap **End face**.

**NOTE** – *You cannot edit the rounds list. Before you tap **End face**, be sure to observe all points to include in the rounds observations.*

### Including/excluding the backsight from a set of rounds

Spectra Geospatial recommends observing the backsight on both faces if you are taking foresight observations on both faces. If you exclude the backsight:

- The backsight observation(s) taken during the station setup is used to compute the MTA.
- if you do not measure the backsight on face 2 and there is only one single face observation to the backsight, and the rounds include observations on both faces, then the horizontal angle face 2 measurements observed using **Measure rounds** will not be used when calculating the MTAs.

### Reviewing standard deviations after rounds

When measuring rounds, use the standard deviation information shown after each round to review the quality of the observations and remove poor observations.

**NOTE** – *Each individual round is stored to the job only when you tap **Close** or **+ Round** to exit the **Standard deviations** screen.*

To observe another round, tap **+ Round**.

To store the current rounds session, tap **Close**. Tap **Yes** to confirm.

To view more information about a point, select it and then tap **Details**.

To view or edit the residuals of each individual observation to a point, tap the point in the list once. If you have enabled a measured point to be added to a CSV file, select the **Add to CSV file** option.

To exit from rounds and delete all rounds observations, tap **Esc**.

If you tap **+Round** after the instrument has completed the required number of rounds, the instrument performs one more round of observations. If you want the instrument to perform more than one extra round, enter the total number of required rounds **before** you tap **+Round**.

For example, to measure three rounds automatically, and then measure another three rounds:

1. Enter 3 in the **Number of rounds** field.
2. Once the instrument has measured 3 rounds, enter 6 in the **Number of rounds** field.
3. Tap **+Round**. The instrument measures the second group of 3 rounds.

## To measure to a surface

Use the **Measure to surface** measurement method to calculate and store the closest distance from the measured point to the selected [surface model](#). The surface can be from an IFC, BIM, DXF, LandXML, DTM or TTM file.

**NOTE** – *If more than one surface is selected, the nearest surface is used.*

1. If the surface is in:
  - any file type except an IFC file, tap  and select **Measure / Measure to surface**. If there is more than one surface available, select the surface in the **Select surface** field.
  - an IFC file, select the surface in the map and then from the tap and hold menu select **Measure to selected surface**.

**NOTE** – *To select the surface the IFC model must be displayed as a solid object and the layer containing the surface must be selectable.*

**TIP** – You can choose whether selecting surfaces in the map selects **Individual faces** or selects the **Whole object**. To change the **Surface selection mode**, tap  and select **Settings**. In the **IFC** group box, select your preferred option from the **Surface selection mode** field. See [Map settings, page 139](#).

2. Enter the **Distance to surface limit**.
3. If required, enter a value in the **Antenna height/Target height** field.

4. Tap **Start**.

If the surface is not already visible in the map, it becomes visible.

The software calculates and reports the closest distance from the current position to the selected surface model and displays it in the **Distance to the surface** field. The **Distance to the surface** is only shown if it is within the **Distance to surface limit**.

The position on the surface is highlighted in the map and a line is drawn from the measured position to the position on the surface. Negative distances are reported for positions between you and the model and positive distances are reported for positions on the other side of the model.

**TIP** – If the software warns **Terrain models disagree**, there are overlapping surfaces with different elevations in the map. Hide any surfaces you are not using in the **Map files** tab of the **Layer manager**. See [To manage map files](#).

5. Enter the **Point name** and, if required, the **Code**.

6. Tap **Measure**.

7. Tap **Store**.

The **Distance to surface** value and the coordinates of the closest point on the surface are stored with the measured point and can be viewed in **Review job** and **Point manager**.

## To measure points on a plane

In a conventional survey, use the Measure points on a plane measurement method to define a plane and then measure points relative to the plane.

To define a horizontal plane, vertical plane, or tilted plane you can select points in the job or measure new points. After defining the plane, measure an:

- **Angle only** measurement to the plane to create an angles and computed distance observation onto the plane.
- **Angles and distance** measurement to the plane to compute the perpendicular offset to the plane.

The type of plane calculated by the software depends on the number of points selected:

No. of points	Plane type
1	Horizontal
2	Vertical through 2 points
3 or more	Plane with residuals (for 3 points, the residuals will be 0). The plane can be a "Free" plane created as a best fit (typically tilted) plane through all points, or a "Vertical" plane constrained to a best fit vertical plane through all points. Tap the <b>Free / Vertical</b> softkey to toggle between the two modes.

1. Tap **≡** and select **Measure / Measure points on plane**.
2. To define the plane:
  - a. Tap **Add** to select the [point selection method](#) and then select the point(s) to use to define the plane, or tap **Measure** to go to the **Measure point** screen and measure a new point to use in the plane definition. Add or measure at least enough points to define the required plane.
  - b. Tap **Calculate** to calculate the plane.
  - c. If the plane uses 3 or more points, you can tap **Vertical** to calculate a vertically constrained plane. If required, tap **Free** to recalculate the plane using the best fit through all points.
  - d. Use the values in the **Residuals** column to identify any points that you want to exclude. Tap a row in the table to exclude or include a point and automatically recalculate the plane. The values in the **Residuals** column are updated.
3. Tap **Continue** to measure points relative to the plane.
4. Enter the **Point name**.
5. Select the **Method** to use for calculating the point:
  - **Angle and distance** calculates coordinates for the measured point as well as the distance from the point to the plane.
  - **Angle only** calculates coordinates for the observed point using the intersection of measured angles and the plane.

**TIP** – When measuring with **Angles and distance**, configure the instrument [EDM settings](#) to turn on tracking mode to see the delta distance to the plane field update in real time.

6. Tap **Measure**.
7. Tap **Store**.

## To measure a point relative to a 3D axis

1. Tap  and select **Measure / Measure 3D axes**.
2. Key in or measure the two points that define a 3D axis.
3. Tap **Options** to select the format of the delta display for the points measured relative to the axis.
4. Tap **Next**.

The instrument is automatically put into TRK mode. When the Origin software receives a distance, the deltas fields are automatically updated.

If you are not measuring to a prism, use Instrument functions to set DR mode.

You can accept the TRK measurement, or tap **Measure** to take an STD measurement.

The Origin software reports the coordinates and elevation for the measured point, and the orthogonal and vertical deltas for the point relative to the 3D axis (see the diagrams below).

5. Enter the **Point name** and, if required, the **Code**.

**NOTE** – *Descriptions and attributes are not supported.*

6. Tap **Store**.

The following diagram and table describes the reported orthogonal deltas using the default format.

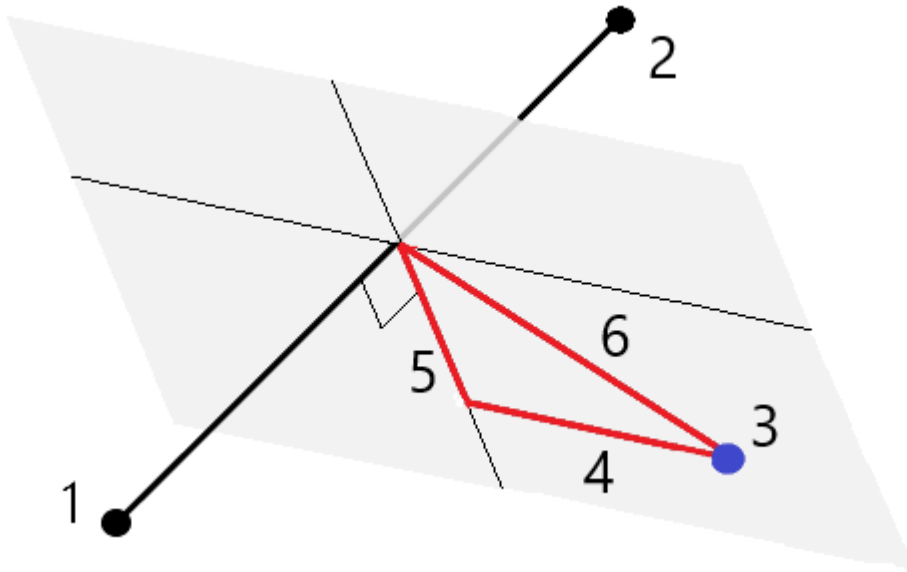

1	Point 1 defining the 3D axis	4	Horizontal offset to 3D axis
2	Point 2 defining the 3D axis	5	Perpendicular offset to orthogonal point on 3D axis
3	Measured point	6	Radial offset to orthogonal point on 3D axis

The following diagram and table describes the reported vertical deltas using the default format.

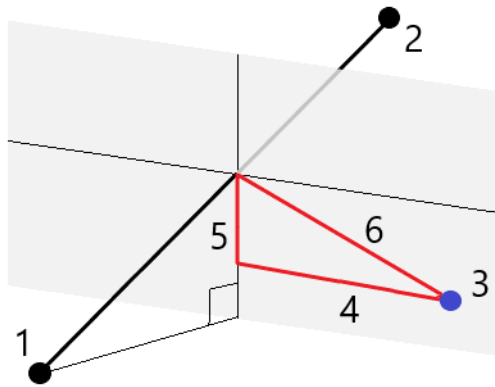

1	Point 1 defining the 3D axis	4	Horizontal offset to 3D axis
2	Point 2 defining the 3D axis	5	Vertical offset to vertical point on 3D axis
3	Measured point	6	Radial offset to vertical point on 3D axis



The Origin software also reports the:

- distance from Point 1 and Point 2 to the calculated orthogonal point on the 3D axis
- distance from Point 1 and Point 2 to the calculated vertical point on the 3D axis
- coordinates and elevation for the calculated orthogonal and vertical points on the 3D axis

**NOTE** - If points 1 and 2 define a vertical axis, all vertical deltas show as null (?).

## To measure continuous topo points

Use the **Continuous topo** measurement method to measure points continuously, for example a line of points at a fixed interval.

You can also use the **Continuous topo** measurement method to store depths measured using an echo sounder. For more information, see [To store depths using an echo sounder](#).

To start **Continuous topo** measurements:

1. Tap  and select **Measure / Continuous topo**.
2. Enter the **Start point name**. The point name increments automatically.
3. If required, enter a value in the **Target height** field.
4. Select the method using the steps below.

## To measure continuous topo points without stopping

1. Select the **Method**.

A point is stored when one of these predefined events occurs:

- the time interval has elapsed (**Fixed time** method)
- the distance has been exceeded (**Fixed distance** method)
- the time interval has elapsed and/or the distance has been exceeded (**Time and distance** or **Time or distance** method)

**NOTE** - For a postprocessed survey, you must use the **Fixed time** continuous method. By default the time interval is set to the same value as the logging interval configured in the **Rover options** screen of the postprocessed survey style.

2. Enter a value in the **Distance** field and/or the **Time interval** field, depending on which method you are using.
3. Tap **Start**. Data starts recording.
4. Move along the feature to be surveyed.  
**TIP** – To store a position before the predefined conditions have been met, tap **Store**.
5. To stop measuring continuous points, tap **End**.

#### To measure continuous topo points using the stop and go method

1. In the **Method** field, select **Stop and go**.
2. In the **Stop time** field, enter the period of time the target must be stationary before the instrument starts to measure the point.  
The target is deemed to be stationary when its velocity is less than 5 cm/sec.
3. Enter a value in the **Distance** field for the minimum distance between points.
4. Tap **Start**. Data starts recording.
5. Move along the feature to be surveyed. A point is stored when the stop time and distance settings have been met.  
**TIP** – To store a position before the predefined conditions have been met, tap **Store**.
6. To stop measuring continuous points, tap **End**.

**NOTE** – If you are using a FOCUS 30/35 instrument with laser blinking enabled, laser blinking is temporarily disabled when using **Continuous topo**.

## Surface scanning

1. From the **Survey** menu, select **Surface scan**.
2. Enter the **Start point name** and **Code**.
3. In the **Method** field, select a measurement method.
4. Define the area for the scan and grid interval using one of the methods described below.

5. Tap the Instrument icon in the status bar to open the **Instrument functions** screen and set the EDM measurement method (TRK is fastest).

The total number of points to scan, scan grid dimensions, and estimated scan time are displayed. Change the scan size, step sizes or EDM measurement method to increase or decrease the number of points and scan time.

6. Tap **Start**.

### To define the scan area

To define the scan area, do one of the following:

- If the point already exists, enter the point name, or use menu arrow to select it from the list.
- From the pop-up menu in the **Top left** and **Bottom right** fields select **Fast fix** or **Measure** to measure and store points that define the limits of the search.

Define the scan area with one of the following methods.

**NOTE** - The defined scan area may not exactly fit the grid interval. There may be an area left over along the scan extents that is smaller than the grid interval. If the width of this area is less than one-fifth of the grid interval, the points along this scan area will not be measured. If the width is more than one-fifth of the grid interval, then an extra point is scanned.

### HA VA interval

Use this method on complex surfaces when you cannot use a rectangular plane to approximate the surface you are scanning.

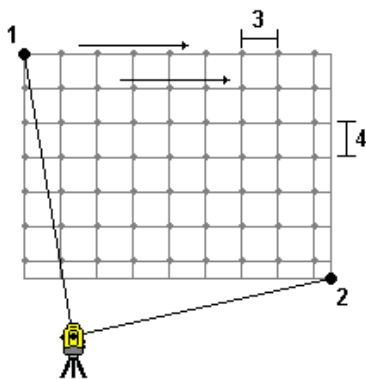

1. Aim to the top left corner of the scan area (1) and measure a point.
2. Aim to the bottom right corner of the scan area (2) and measure another point.

3. Define the angular grid interval, where:

3 is the Horizontal angle

4 is the Vertical angle

**TIP** - To define a Horizontal only scan of a  $360^\circ$  scan area, set the Top left and Bottom right points to the same name, and set the VA interval to null.

#### Rectangular plane

Use this method on a plane surface where you need a regular grid interval. The Origin software determines the angle of the plane, and uses this and the grid interval to approximate how far to turn the instrument for each subsequent point.

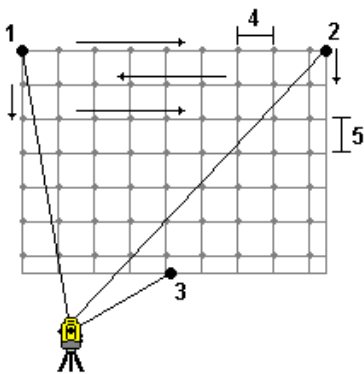

1. Aim to the first corner of the scan area (1) and measure a point.
2. Aim to the second corner of the scan area (2) and measure another point.
3. Aim to the third point on the opposite side of the plane (3) and measure a point.
4. Define the distance grid interval, where:
  - 4 is the horizontal distance
  - 5 is the vertical distance

#### Line and offset

Use this method to define the area to scan from a centerline that has equal offsets to the left and right. The Origin software defines the surface using horizontal offsets perpendicular to the centerline. The software then uses this definition and the station interval to determine approximately how far to turn the instrument for each subsequent point.

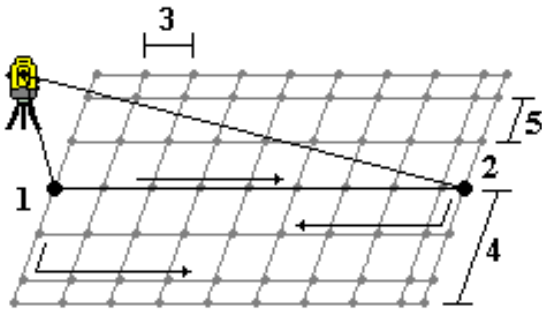

1. Do one of the following:

- Two point method:
  - a. Aim to the start point of the centerline (1) and measure a point.
  - b. Aim to the end point of the centerline (2) and measure another point. These two points (1 and 2) define the centerline.
- Access the pop-up menu in the **Start point** field. Change the method and then define the line by a start point with azimuth and length.

2. Define the station interval (3).

3. Define the maximum offset distance (4).

4. Define the offset interval (5).

The Origin software scans the centerline first, then the points on the right-hand side, and finally the left-hand side.

## GNSS survey measure methods

The types of points that you can measure in a GNSS survey depend on the type of GNSS survey configured in the survey style.

To measure points, tap  and select **Measure / Measure points**, or in the map, with nothing selected, tap **Measure**.

In the **Method** field, select:

- **Topo point** to measure a topographic point.
- **Observed control point** to measure a point with an extended occupation time and quality control information.

***NOTE** – If the **Topo point** is configured to perform 180 measurements in the [GNSS point options](#) screen, the positional result is the same as a point measured using the observed control point measurement method.*

- **Calibration point** to measure a point during site calibration.
- **Rapid point** to quickly measure a point with no minimum occupation time.

***NOTE** – In an RTK and Data logging survey, points measured using the [Rapid point method](#) are not saved to the T01/T02 file and are not available for postprocessing.*

- **MultiTilt point** to measure a point using three contributing tilted eBubble measurements.

***NOTE** – MultiTilt is available only when using a receiver with an eBubble. It is not available in data logging surveys.*

- **Compensated point** to measure a point using an unlevelled pole with a Spectra Geospatial SP80/SP85 receiver, and have the antenna's offset location corrected to produce a ground position at the tip of the pole.

**NOTE** – If you have turned off *Tilt* in the **Rover Options** form or set the **Broadcast format** to *RTX* when configuring the survey style, then the compensated point measurement method is not available.

- **Fast static** to measure points without tracking satellites between points. This option is available only when in a FastStatic survey.

From the **Measure** menu, you can also:

- Use **Measure codes** to measure and code observations in one step.
- Use **Measure to surface** to calculate and store the closest distance from the measured point to the selected surface.
- Use **Continuous topo** to measure a line of points at a fixed interval.

See also:

- [To measure points using a laser rangefinder, page 428](#)
- [To store depths using an echo sounder, page 431](#)
- [To measure a check point, page 481](#)
- [Construction points, page 216](#)

## To measure a topo point

The **Topo point** method is the most frequently used measurement method. You can measure a topo point in any type of GNSS survey except a FastStatic survey.

1. Tap  and select **Measure / Measure points**, or in the map, with nothing selected, tap **Measure**.
2. In the **Method** field, select **Topo point**.
3. Enter the **Point name** and **Code**. See [To select feature codes, page 485](#).

If the selected code has attributes, the **Attrib** softkey appears. Tap **Attrib** and fill out the attribute fields. See [To enter attribute values when measuring a point, page 487](#). Tap **Store**.

4. Enter a value in the **Antenna height** field and make sure that the setting in the **Measured to** field is set appropriately.

5. Position the receiver and tap **Measure**.

If you are using a receiver that supports the [GNSS eBubble](#), use the eBubble to level the pole. The status bar shows . Keep the pole vertical and stationary during measurement.

**TIP** – To measure points more quickly, enable **Auto-measure** to automatically initiate a measurement. See [Auto-measure, page 358](#).

6. When the preset occupation time and precisions have been reached, the point is automatically stored when **Auto store point** is enabled. If **Auto store point** is not enabled, tap **Store**. See [Auto-store point, page 357](#).

**TIP** –

- To search for the next available point name, tap **Find**. Enter the point name you want to start searching from (for example, 2000) and tap **Enter**. The software searches for the next available point name after 2000 and inserts it in the **Point name** field.
- To add a vertical offset to the measured point, tap **Options**. Select **Add vertical offset** and then in the **Measure points** screen enter a value in the **Vertical offset** field.
- To configure quality, precision, and other settings, tap **Options**. See [GNSS point options, page 356](#).
- To accept the measurement before the occupation time or precision requirements have been satisfied, tap the blank softkey in the bottom right corner.

## To measure continuous topo points

Use the **Continuous topo** measurement method to measure points continuously, for example a line of points at a fixed interval. Measuring points along a feature requires following the feature closely with the pole tip as you move along the feature.

**TIP** – You can also use the **Continuous topo** measurement method to store depths measured using an echo sounder. For more information, see [To store depths using an echo sounder](#).

To start **Continuous topo** measurements:

1. Tap  and select **Measure / Continuous topo**.
2. Enter the **Start point name**. The point name increments automatically.



3. If required, enter a value in the **Antenna height** field.
4. Select the method using the steps below.

#### To measure continuous topo points without stopping

1. Select the **Method**.

A point is stored when one of these predefined events occurs:

- the time interval has elapsed (**Fixed time** method)
- the distance has been exceeded (**Fixed distance** method)
- the time interval has elapsed and/or the distance has been exceeded (**Time and distance** or **Time or distance** method)

**NOTE** – For a postprocessed survey, you must use the **Fixed time** continuous method. By default the time interval is set to the same value as the logging interval configured in the **Rover options** screen of the postprocessed survey style.

2. Enter a value in the **Distance** field and/or the **Time interval** field, depending on which method you are using.
3. Tap **Start**. Data starts recording.
4. Move along the feature to be surveyed, following the feature closely with the pole tip as you move along the feature.

If **Tilt functions** are enabled in the survey style, the status bar shows . You must keep the pole vertical as you move along the feature. If **Tilt warnings** are enabled, a point is not stored until the receiver is within the defined tilt tolerance.

5. Points are stored automatically when the preset occupation time and precisions have been reached. To store a position before the predefined conditions have been met, tap **Store**.
6. To stop measuring continuous points, tap **End**.

### To measure continuous topo points using the stop and go method

1. In the **Method** field, select **Stop and go**.
2. In the **Stop time** field, enter the period of time the target must be stationary before the instrument starts to measure the point.

The target is deemed to be stationary when its velocity is less than 5 cm per second.

3. Enter a value in the **Distance** field for the minimum distance between points.
4. Tap **Start**. Data starts recording.
5. Move along the feature to be surveyed, following the feature closely with the pole tip as you move along the feature.

If **Tilt functions** are enabled in the survey style, the status bar shows . You must keep the pole vertical as you move along the feature. If **Tilt warnings** are enabled, a point is not stored until the receiver is within the defined tilt tolerance.

6. Points are stored automatically when the stop time and distance settings have been met. To store a position before the predefined conditions have been met, tap **Store**.
7. To stop measuring continuous points, tap **End**.

### To measure an observed control point

Use the **Observed control point** method to measure a point with an extended occupation time and quality control information.

**NOTE** – For an RTK survey, initialize the survey before starting to measure the point. For a Postprocessed Kinematic survey, you can start measuring a point before initialization, but you should not store it until you have initialized the survey.

1. Tap  and select **Measure / Measure points**, or in the map, with nothing selected, tap **Measure**.
2. Select **Observed control point** in the **Method** field.
3. Enter the **Point name** and **Code**.. See [To select feature codes, page 485](#).

If the selected code has attributes, the **Attrib** softkey appears. Tap **Attrib** and fill out the attribute fields. See [To enter attribute values when measuring a point, page 487](#). Tap **Store**.

4. Enter a value in the **Antenna height** field and make sure that the setting in the **Measured to** field is set appropriately.
5. To configure quality, precision, and tilt settings, tap **Options**. See [GNSS point options, page 356](#).
6. If you are using a receiver that supports the [GNSS eBubble](#), use the eBubble to level the receiver and make sure the pole is vertical and stationary. To show or hide the eBubble from any screen, press **Ctrl + L**.
7. Tap **Measure**.

The static measuring mode icon  in the status bar indicates the pole should be vertical while you measure the point.

8. When the preset occupation time and precisions have been reached, tap **Store**.

If you have been measuring the point for longer than 15 epochs and the precisions go out of tolerance, a message warns that the occupation timer will reset and allows you to store the last position with good precisions. Tap **Yes** to store the last good position. Tap **No** to reset the timer and continue measuring the point.

To accept the measurement before the occupation time or precision requirements have been satisfied, or if there has been movement, tilt, or precision warnings during the occupation, tap



## To measure rapid points

Use the **Rapid point** method to quickly measure points with no minimum occupation time.

**TIP** – Because the software collects just one epoch of roving mode data when the preset precisions are reached, Spectra Geospatial recommends setting the default precision values higher for the **Rapid point** method than for other point measurement types. To configure quality, precision, and other settings, tap **Options**. See [GNSS point options, page 356](#).

1. Tap  and select **Measure / Measure points**, or in the map, with nothing selected, tap **Measure**.
2. Select **Rapid point** in the **Method** field.
3. Enter the **Point name** and **Code**.

4. Enter a value in the **Antenna height** field and make sure that the setting in the **Measured to** field is set appropriately.
5. Position the receiver and tap **Measure**.

If you are using a receiver that supports the [GNSS eBubble](#), use the eBubble to level the pole. The status bar shows . Keep the pole vertical and stationary during measurement.

**TIP** – To measure points more quickly, enable **Auto-measure** to automatically initiate a measurement. See [Auto-measure, page 358](#).

The point is automatically stored when the preset precisions are reached.

## To measure a MultiTilt point

Use the **MultiTilt point** measurement method to measure a point using three contributing tilted eBubble measurements.

**NOTE** – *MultiTilt is available only when using a receiver with an eBubble and when **Tilt functions** are enabled in the survey style. To be able to measure MultiTilt points the GNSS receiver **must** have a properly calibrated eBubble. The **MultiTilt point** measurement method is **not** available in data logging surveys.*

**TIP** – The **MultiTilt point** measurement method does not use a magnetometer so if your GNSS receiver has one the magnetometer does not need to be calibrated before using MultiTilt.

### How the MultiTilt point measurement method works

When you measure a **MultiTilt point**, you position the tip of the pole at the desired measurement location, and **keep the pole tip fixed at the same location** during the entire measurement process. Tilt the pole first in one direction and measure, tilt the pole in the second direction and measure, and then tilt the pole in the third direction and measure.

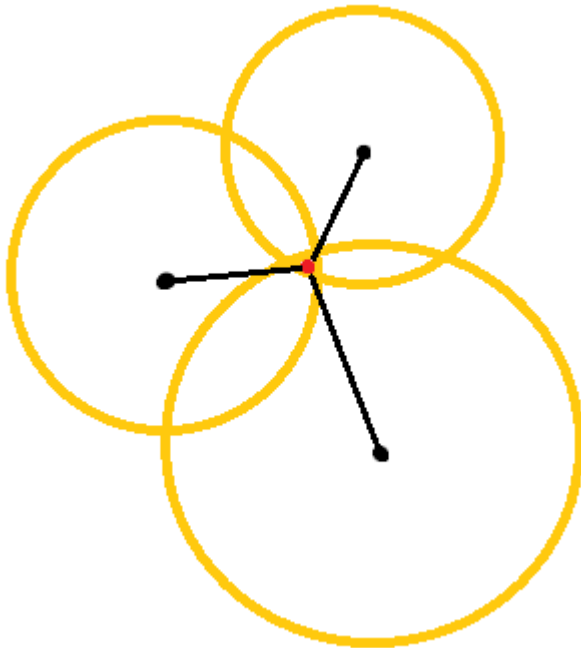

The diagram above shows the three tilt circles that are created when you tilt the antenna to three different positions, where each antenna position is indicated by a black dot at the center of each tilt circle. The tilt circles have a radius equal to the current tilt distance, and each tilt circle represents the circle of possible locations of the pole tip at that distance from the antenna position. To calculate the location of the pole tip, the software calculates the point at which the three tilt circles intersect.

### To measure a MultiTilt point

The steps below guide you through measuring three tilted observations, where the software automatically measures when the pole is held still, and computes the resulting point using the intersections of the three tilt circles observed with the tilted pole:

1. Tap  and select **Measure / Measure points**, or in the map, with nothing selected, tap **Measure**.
2. Select **MultiTilt point** from the **Method** field.

3. Enter the **Point name** and **Code**.
4. If the selected code has attributes, the **Attrib** softkey appears. Tap **Attrib** and fill out the attribute fields. See [To enter attribute values when measuring a point, page 487](#). Tap **Store**.
5. Enter a value in the **Antenna height** field and make sure that the setting in the **Measured to** field is set appropriately.

***NOTE** – Antenna height is critical in the MultiTilt computations. Make sure the entered antenna height and measurement method is set correctly before beginning a MultiTilt point measurement.*

6. To configure the quality control and precision settings, tap **Options**.

***NOTE** – The precisions shown in the status line reflect the amount of tilt of the antenna. If measuring points with large amounts of tilt, you may need to increase the precision tolerance setting.*

7. Position the tip of the pole at the desired measurement location. Do not move the tip through the entire measurement process.
8. Keeping the pole tip at the desired measurement location, tilt the pole to the desired angle. The eBubble shows the amount of tilt of the antenna.

***NOTE** – The eBubble turns yellow if the tilt exceeds 30 degrees. This indicates when the precision of the RTK solution produced may become unreliable due to the tilt being outside the acceptable tilt range. The measurements in this range may remain usable if the precision estimates are acceptable to you. The eBubble turns red if the tilt exceeds 45 degrees.*

9. Tap **Measure**.

The **MultiTilt status** field indicates the process of taking three tilted rapid point measurements. It shows **Waiting to measure** when the antenna is moving, **Move antenna** when a measurement has been taken and the software is waiting for the antenna to move an acceptable amount for another measurement to be taken, and **Measuring – hold still** when the antenna is being held completely still while tilted.

10. To ensure good intersection geometry of the three contributing measurements, move the antenna as much as practicable between the three stationary measurements, so that the three antenna positions form a triangular shape rather than a straight line.

The counter indicates the remaining number of stationary measurements. The map shows yellow circles representing the three tilt measurements, and a cross representing the result once the third measurement is taken.

11. When the result has been computed and the precisions are acceptable, tap **Store**.

If the precision of the resulting intersection is not acceptable, tap **Esc** to discard the three measurements and then remeasure the MultiTilt point.

**TIP** – If the antenna height is correct and the eBubble is properly calibrated, the resulting intersection of the three circles should be centimeter-level. If the circles do not overlap at a discrete point or the precisions are too high:

- Check your eBubble calibration is of high quality, and make sure that the entered antenna height and measurement method are correct. You cannot correct for these errors after storing a MultiTilt point.
- Remeasure the point, changing your points of measurement by tilting further away or even a bit closer.

## To measure to a surface

Use the **Measure to surface** measurement method to calculate and store the closest distance from the measured point to the selected [surface model](#). The surface can be from an IFC, BIM, DXF, LandXML, DTM or TTM file.

**NOTE** – *If more than one surface is selected, the nearest surface is used.*

1. If the surface is in:
  - any file type except an IFC file, tap  $\equiv$  and select **Measure / Measure to surface**. If there is more than one surface available, select the surface in the **Select surface** field.
  - an IFC file, select the surface in the map and then from the tap and hold menu select **Measure to selected surface**.

**NOTE** – To select the surface the IFC model must be displayed as a solid object and the layer containing the surface must be selectable.

**TIP** – You can choose whether selecting surfaces in the map selects **Individual faces** or selects the **Whole object**. To change the **Surface selection mode**, tap  and select **Settings**. In the **IFC** group box, select your preferred option from the **Surface selection mode** field. See [Map settings, page 139](#).

2. Enter the **Distance to surface limit**.
3. If required, enter a value in the **Antenna height/Target height** field.
4. Tap **Start**.

If the surface is not already visible in the map, it becomes visible.

The software calculates and reports the closest distance from the current position to the selected surface model and displays it in the **Distance to the surface** field. The **Distance to the surface** is only shown if it is within the **Distance to surface limit**.

The position on the surface is highlighted in the map and a line is drawn from the measured position to the position on the surface. Negative distances are reported for positions between you and the model and positive distances are reported for positions on the other side of the model.

**TIP** – If the software warns **Terrain models disagree**, there are overlapping surfaces with different elevations in the map. Hide any surfaces you are not using in the **Map files** tab of the **Layer manager**. See [To manage map files](#).

5. Enter the **Point name** and, if required, the **Code**.
6. Tap **Measure**.
7. Tap **Store**.

The **Distance to surface** value and the coordinates of the closest point on the surface are stored with the measured point and can be viewed in **Review job** and **Point manager**.



## To measure a check point

In a real-time GNSS survey, measure a point twice. Give the second point the same name as the first point. If the duplicate point tolerances are set to zero, the software warns that the point is a duplicate when you try to store it. Select **Store as check** to store the second point as a check class point. See [Managing points with duplicate names, page 200](#).

## To measure a compensated point

**NOTE** – This measurement method is only available when you are using a Spectra Geospatial SP80 or SP85 receiver and **Tilt functions** are enabled in the survey style. To be able to measure compensated points the GNSS receiver must have a properly calibrated eBubble and magnetometer. See [Magnetometer calibration, page 417](#).

1. Tap  and select **Measure / Measure points**, or in the map, with nothing selected, tap **Measure**.
2. Select **Compensated point** from the **Method** field.
3. Enter the **Point name** and **Code**.
4. If the selected code has attributes, the **Attrib** softkey appears. Tap **Attrib** and fill out the attribute fields. See [To enter attribute values when measuring a point, page 487](#). Tap **Store**.
5. Enter a value in the **Antenna height** field and make sure that the setting in the **Measured to** field is set appropriately.
6. To configure the quality control and precision settings, tap **Options**.

**NOTE** – The precisions shown reflect the amount of tilt of the antenna. If measuring points with large amounts of tilt, you may need to increase the precision tolerance setting.

7. Position the antenna and make sure it is stationary.

The eBubble shows the amount of tilt of the antenna.

**NOTE** – An "Excess tilt" message appears in the status bar and the eBubble turns red if the tilt exceeds 15 degrees. If you can, level up the antenna so there is less tilt. If you are unable to decrease the tilt to less than 15 degrees, perform an offset measurement instead. See [Compute point, page 228](#).

8. Tap **Measure**. The compensated point icon appears in the status bar. The eBubble changes to help you hold the antenna stationary.

- When the preset occupation time and precisions have been reached, tap **Store**.

To accept the measurement before the occupation time or precisions have been satisfied, tap **Enter**.

**TIP** – To speed up your workflow, select one or both of the following check boxes in the **Options** screen:

- To start measuring automatically when the receiver is within a specified tilt tolerance, select **Auto-measure** in the **Tilt** group box. See [GNSS point options, page 356](#).
- To automatically store the point when the occupation time and precisions have been reached, select **Auto store point**.

## To measure FastStatic points

This type of point is measured in a FastStatic survey.

**NOTE** – *FastStatic surveys are postprocessed and do not need to be initialized.*

- Tap  and select **Measure / Measure points**, or in the map, with nothing selected, tap **Measure**.
- Enter the **Point name** and **Code**.
- Enter a value in the **Antenna height** field and make sure that the setting in the **Measured to** field is set appropriately.
- Tap **Measure** to start measuring the point.
- When the preset occupation time is reached, tap **Store**.

Receiver type	4 SVs	5 SVs	6+ SVs
Single-frequency	30 min	25 min	20 min
Dual-frequency	20 min	15 min	8 min

No satellite tracking is necessary between measuring points. The occupation time counter for measuring a FastStatic point pauses when the PDOP of the satellites being tracked exceeds the PDOP mask set in the survey style being used. The counter resumes when the PDOP falls below the mask.

**NOTE** – The number of satellites required for measuring a FastStatic point depends on whether you are using GPS satellites only, BeiDou satellites only or a combination of GPS, BeiDou, GLONASS, Galileo and QZSS satellites. The following table summarizes the **minimum** requirements:

Satellite systems	Required satellites
GPS only	4 GPS
GPS + QZSS	3 GPS + 1 QZSS
GPS + GLONASS	3 GPS + 2 GLONASS
GPS + BeiDou	3 GPS + 2 BeiDou
GPS + Galileo	3 GPS + 2 Galileo
BeiDou only	4 BeiDou
BeiDou + GPS	3 BeiDou + 2 GPS
BeiDou + GLONASS	3 BeiDou + 2 GLONASS
GLONASS only	N/A
Galileo only	N/A

## Measurement messages and warnings

Depending on the equipment you are using and the settings you have configured in the survey style, different types of warnings may appear during when measuring points in a GNSS survey.

### GNSS messages

To discard GNSS messages and prevent them reappearing, tap **Ignore** in the message. For non-RTX messages, the message is discarded and does not appear again. For Trimble RTX correction service messages, only messages regarding the same subscription status are ignored; if the subscription status changes then the Ignore setting is reset and messages appear. Tapping **Ignore** is controller-specific; if you use the same GNSS receiver with a different controller then the Ignore setting for that controller is used and the messages may reappear.

## Occupation warnings

During a point measurement the software warns if there are adverse conditions that result in any of the tolerances being exceeded and prevent the point being stored.

To accept the measurement before the occupation time or precisions have been satisfied or while there are conditions preventing point storage, tap .

When you tap **Store**, the **Confirm and store point?** screen lists all issues that occurred during the measurement, in order of priority.

Tap **Yes** to store the point. Tap **No** to discard the point. To remeasure the point, tap **Remeasure**.

The **Position compromised** warning appears when the receiver is in static mode measuring a point and a new GNSS position is different from the immediately previous GNSS position by more than the current 3-sigma precision estimates. This warning appears only when the difference in position is larger than the current precision tolerances, and if the GNSS receiver does not produce excess movement warnings of its own during the occupation. The position compromised warning can occur in severely marginal GNSS environments where there is a lot of multipath or signal attenuation. The QC1 occupation warnings information enables you to tell if this happened while observing a point stored in the database.

**NOTE** - *No occupation warnings appear when you are measuring a Rapid point.*

If you are using a GNSS receiver with a built-in tilt sensor, tilt warnings may also appear. See [GNSS eBubble tilt warnings, page 412](#).

## Measuring points with feature codes

This section provides information on using codes from the feature library to code points as you measure them and, if required, fill out attributes for the measured point. You can add codes to a point from the **Measure point**, **Measure topo** or **Measure codes** form.

Select a **feature code** to identify the point as a specific feature type. If the feature code has **attributes** then the Origin software prompts you to enter the attribute data.

If the **feature library** contains **control codes**, then you can use the [CAD toolbar](#) to create line, arc, or polygon features from points as you measure them.

During a conventional or GNSS survey, to measure and code observations in one step, tap and select **Measure / Measure codes**. See [Measuring and coding observations in one step, page 490](#).

### To select feature codes

Select the feature code for a point from the **Code list**. To view the **Code list** form, do one of the following:

- Tap inside the **Code** field in the **Measure** form.
- Press the right arrow key when measuring a point.
- Tap and hold on a code button in the **Measure codes** form.

The **Code list** form lists all the codes in the selected feature library. Refer to the sections below for information on selecting codes and filtering the **Code list**.

**TIP** – To quickly reuse a code from an existing point, tap inside the **Code** field of the **Measure** form or the **Code** field at the top of the **Code list**, and then tap the existing point on the map. The software populates the **Code** field with the code(s) of the selected point.

### To select codes

1. Select the code from the list or type it in the field near the top of the list.

Searching by **Code** automatically selects the first item found in the **Code list**. Tap or press **Enter** to add the selected code to the **Code** field for the current point.

Searching by **Description** does not automatically select any item in the **Code list**. Tap an item or use the arrow key to select it and then tap or press **Enter** to add the code to the **Code** field for the current point.

2. To enter multiple codes, for example to add control codes to a point to build a feature geometry, select each code in turn from the list. The software automatically enters a space to separate each code.

If you enter codes through the controller keypad, you must enter a space after each code to display the entire code list again before you enter the next code.

**NOTE** – The maximum number of characters allowed in the **Code** field is 60.

3. Tap **Enter**.

**TIP** – To enter a code that is not in the library, but which has a similar entry in the library, press the space key to accept the code that you enter instead of the similar code from the library. Alternatively, [disable auto-complete](#).

To filter the list of codes

- Tap **Code** to search by **Code** or tap **Description** to search by **Description**. Depending on your selection, the software shows items in the feature library that have codes or descriptions starting with the text you entered.

If you are searching by **Code**, text you enter in the code field will auto complete to match existing codes in the list. Text does not auto complete when you are searching by **Description**.

- To search based on a series of characters that appear **anywhere** within the code or description, tap **Match**. All items in the FXL that contain the exact string entered are listed.

The **Match** function can be enabled separately for codes and for descriptions.

**NOTE** – You must enter the exact string to find. You cannot enter an asterisk (\*) as a wildcard character when using the **Match** function.

- To filter the entire feature code list by either code **Type**, for example point or control code, or by the **Category** as defined in the feature library, tap . The **Set code list filters** screen appears. Tap a feature type or a feature category to show/hide it. Tap **Accept** to return to the code list.

**TIP** – When you select a code from the list, any filtering is disabled and the entire feature code list appears, which allows you to select another code.

#### To edit values in the Code field

When editing a Code field, tap inside the Code field. The **Code list** appears with the existing contents of the Code field highlighted. To replace the entire contents, select a new code. To remove the highlight before you select the new code, tap at the beginning or end of the code field, or press the left or right arrow key.

To edit the Code field, use the arrow keys to navigate to the correct position and then use the backspace key to remove unwanted characters. As the code is modified, the code list filters accordingly.

#### To disable auto-complete

By default, auto-complete is enabled. To disable auto-complete, tap the **Auto off** softkey.

When auto-complete is turned off, recently used codes appear at the top of the code list. Multiple entry codes are remembered as a single entry in the recently used list. This allows you to quickly select recently used codes, especially multiple code entries.

### To enter attribute values when measuring a point

1. Enter the point name and select a code. If the code has attributes, the **Attrib** softkey appears in the **Measure** screen.

Feature codes that have attributes have an attribute icon (Ⓐ) next to the feature code in the library.

2. To make the attribute form appear when a point is stored for which there are required attributes but no value has yet been entered, tap **Options** and select **Prompt for attributes**.

**NOTE** – When **Prompt for attributes** is enabled:

- If you already entered attributes by tapping the **Attrib** softkey, you are not prompted for attributes.
- If attributes that are set as required are assigned a default value in the feature library, you are not prompted for attributes.

3. To enter attributes, tap the **Attrib** softkey.
4. To select the default attribute values, tap **Options** and select:

- **Last used** to use the attribute values for the last measured point
  - **From library** to use the default attribute values from the feature library
5. Enter the attributes of the point you are measuring.
  6. Tap **Store**.



**TIP** – To streamline the process for capturing images and linking them to attributes, see [To link an image to an attribute, page 488](#).

## To link an image to an attribute

If a point has a file name attribute, you can use the file name attribute to link an image to the attribute.

**NOTE** – *You should not rename a file after attaching it to an observation. Files renamed after attaching will not be downloaded with the job.*

### To capture and link an image to an attribute



1. In the measure or stakeout screen, enter the feature code. The feature code must have a file name attribute.  
  
If the code has multiple file name attributes, or if the point has multiple codes, the image will be linked to the first file name attribute that appears when you view the attribute screen.
2. To link the image to a specific file name attribute, tap **Attrib** and select the required file name field.
3. Measure the point.  
  
If the **View before storage** check box is enabled in the **Measure point options** screen, then the attribute form automatically appears when you store the point.
4. To view the attributes screen, tap **Attrib**.
5. To capture an image using the camera in the controller, tap  in the attribute form or press the appropriate key on the controller keypad.  
  
The name of the image appears in the photo file name field.
6. To review the image; tap  next to the photo file name field and select **Review**.



**NOTE** – In a conventional survey, if you selected the **Attrib** softkey before measuring and storing the point **and** you have elected to annotate the image with the position coordinates, the coordinates are shown as null because the point has not yet been measured.

7. Tap **Store**.

#### To link a captured image to an attribute

1. In the measure or stakeout screen, enter the feature code. The feature code must have a file name attribute.
2. To view the attributes screen, tap **Attrib**.
3. In the photo file name field, tap  and select the file to link to the attribute.  
The name of the image appears in the photo file name field.
4. To review the image, tap  and select **Review**.
5. To select a different image, tap  and tap **Select file**. Browse to the location of the file you want to link and select it.

**TIP** – To facilitate automatic upload of images to the cloud with the job, the image should be located in the current **<job name> Files** folder.

6. Tap **Store**.

#### To change the image file linked to a point or attribute

1. You can change the image file linked to an attribute in the **Review job** or **Point manager** screen:
  - In the **Review job** screen, select the point you want to edit and tap **Edit**.
  - In the **Point manager** screen, select the point you want to edit and tap **Details**.
2. If the image is linked to an attribute, tap **Attrib**. If the image is linked to the point, tap **Media files**. (In portrait mode, swipe right to left along the row of softkeys to view the **Media files** softkey.)
3. In the photo file name field, tap  and tap **Select file**. Browse to the location of the file you want to link and select it.

The name of the image appears in the photo file name field.

**TIP** – To facilitate automatic upload of images to the cloud with the job, the image should be located in the current **<job name> Files** folder.

4. Tap **Store**.

## To resurvey points that already have attributes

To stake out and remeasure points for which you already have attribute data:

1. If the job is not yet on the controller, transfer it to the controller, making sure you transfer relevant features and attributes as well as the points.
2. Tap  and select **Stakeout / <Style name> / Points**.
3. Tap **Options** and from the **As-staked point details** group, set the **As-staked code** field to **Design code**.
4. Stake out the point.
5. Measure the as-staked point.

The attribute data displayed for the point is the attribute data that you entered previously. The defaults in the feature library are not used. Update the values as required.

## Measuring and coding observations in one step

To measure and code conventional or GNSS observations in one step, select the feature code you want to measure and store from the **Measure codes** form. If you are using a feature library file that has groups defined, the groups and the codes within the group are automatically shown in the **Measure codes** form.

To quickly change the code on a code button, tap and hold the button on the **Measure codes** form and select a different code. When you save the change the software returns to the **Measure codes** form.

To edit multiple buttons, create or manage groups of code buttons, or to configure template pickup, use the **Edit Measure codes** screen. To view the **Edit Measure codes** screen, tap  in the **Measure codes** form. See [To set up code buttons for Measure codes, page 491](#)

During a survey, when you tap one of the code buttons in the **Measure codes** form, the code on that button is added to the **Code** field at the bottom of the **Measure codes** form. Alternatively, you can use the numeric keypad on the controller to select the required code button. When using a 3x3

layout, keys 7, 8, 9, activate the top row of buttons, keys 4, 5, 6 activate the middle row of buttons, keys 1, 2, 3 activate the bottom row of buttons.

To combine codes from multiple code buttons, tap the **Multi-code** button  and then tap each code button in the **Measure codes** form to add the code to the **Code** field.

**TIP** – If you are using **control codes** to create line, arc, or polygon features from points as you measure them, the fastest and easiest way to do this is to select the appropriate control code from the [CAD toolbar](#).

If a code has attributes, the attribute values appear at the bottom of the **Measure codes** form. You cannot directly edit these attribute values in the form. To change the attribute values, tap **Attrib** in the **Measure codes** form or in the **Measure topo** or **Measure point** form. For more information, see [To enter attribute values when measuring a point, page 487](#).

### To set up code buttons for Measure codes

To quickly change the code on a code button, tap and hold the button on the **Measure codes** form and select a different code. When you save the change the software returns to the **Measure codes** form.

To edit multiple buttons, create or manage groups of code buttons, or to configure template pickup, use the **Edit measure codes** screen. To view the **Edit measure codes** screen, tap  in the **Measure codes** form.

### To create a code group

1. Tap **New group**.
2. Enter the **Code group name**.
3. Tap **Accept**.

New groups are added after the current group. To add a group to the end of existing groups, ensure you select the last group before selecting **Add group**.

If you are not using a feature library that has groups defined, you must select the codes from the feature library that you want to appear on the form. You can define multiple pages of codes, each consisting of up to 25 codes.

### To assign codes to buttons

- To edit an existing code group, select the group from the **Group** drop-down list.
- To add a code to an empty button, tap the button and select the code from the list of codes in the feature library and then tap **Enter**.

- You can also select code buttons using the keypad. Navigate to the button using the arrow keys, and then press the **Space** key.
- To change the code assigned to a button:
  - If the button is already highlighted, tap it once.
  - If it is not already highlighted tap it once to highlight it and again to change it.
- To add another code to the same button, enter a space in the text field next to the first code, and then enter or select the second code. See [To select feature codes, page 485](#).
- To change the number of code buttons that appear in the group, change the value in the **Code button layout** field. You may need to scroll down the **Edit Measure codes** screen to view this field.
- To reorder buttons in the group, if the button is not already highlighted, tap the button to select it and then tap the left arrow or right arrow softkey to move the button. The other buttons in the group shuffle automatically.
- To create a template so that when measuring groups of observations that are typically coded in a regular pattern the software automatically selects the appropriate code for the next observation, configure the settings in the **Template pickup** group. See [To create a template of a measurement code sequence, page 493](#).
- Tap **Accept**.

**TIP** – If required, you can also enter additional description fields that are not in the feature library. See [Additional settings, page 108](#).

#### [To change the number of code buttons that appear in the group](#)

To change the number of code buttons that appear in the group, change the value in the **Code button layout** field. You may need to scroll down the **Edit Measure codes** screen to view this field.

The list of codes for each group is independent. For example, if you create codes for buttons using a 3x3 layout and then change the layout to 3x4, then three additional empty buttons are added to the group. The software does not move three buttons from any other group into the current group.

**NOTE** – The codes defined for a group are remembered, even if they are not displayed. For example, if you create codes for buttons using a 3x4 layout and then change the layout to 3x3, only the first nine codes are displayed. If you change the layout back to 3x4, all twelve codes are displayed.

### To delete buttons or groups



Use the **Delete** softkeys to delete buttons or groups. (In portrait mode, swipe right to left along the row of softkeys to view more softkeys.)

- To delete a button, tap the button to select it and then tap **Delete**. The other buttons in the group shuffle automatically to replace the deleted button.
- To delete the currently selected group, tap **Delete group** and then tap **Yes**.
- To delete all codes in the group, tap **Delete all** and then tap **Yes**.

### To create a template of a measurement code sequence

To automatically select the next code button in the code group after storing a measurement using **Measure codes**, configure the **Template pickup** settings in the **Edit Measure codes** screen.

Template pickup is particularly useful when coding observations in a regular pattern, for example, a road cross section.

1. Tap  and select **Measure / Measure codes**.
2. In the **Measure codes** form, tap . The form changes to the **Edit Measure codes** screen.
3. In the **Template pickup** group, select the **Enable** check box to enable template pickup on the code buttons in the group. The template icon  appears on each code button used in the template.
4. In the **Number of elements** field, enter the number of elements in the template. The number of elements in the template can be fewer than the number of buttons in the group.

For example, in a 3x3 button layout you could choose to have 6 buttons in the template and use the additional 3 buttons in the group for extra items that you commonly measure but that are not part of the template. The first 6 buttons would be included in the template, but you can reorder the buttons as required. Tap a button to select it and then tap the left arrow or right arrow softkey to move the button.

5. Configure the template pickup **Direction**. Refer to the following diagram:

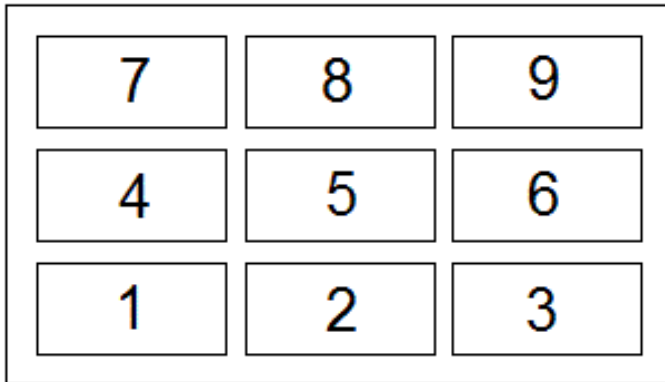

For the example above, where the template uses 6 buttons (buttons 4 through 9):

- **Left to right** – The highlight moves from 7-9, then 4-6, then 7-9 again and so on.
- **Right to left** – The highlight moves from 6-4, then 9-7, then 6-4 again and so on.
- **Zig zag** – The highlight moves from 7-9, 4-6 then 6-4, 9-7, then 7-9 again and so on.

**NOTE** – During measurement, you can skip a code in the template by tapping a different code button or by using the arrow keys to select a different button.

### Measure code options

To configure options when measuring using Measure codes, tap **Options** when viewing the **Measure codes** form. (In portrait mode, swipe right to left along the row of softkeys to view the **Options** softkey.)

### String suffix

Measure codes has + and - softkeys that enable you to apply a suffix to the code on the button. This is useful when you use the stringing method for feature coding.

Select the format of the suffix from the **String suffix** field. You can select **1**, **01**, **001**, or **0001**.

### Auto measure

The **Auto measure** check box controls whether the software starts measuring as soon as you move from the **Measure codes** screen to the **Measure topo** or **Measure point** screen. Clear the **Auto measure** check box if you want to be able to change measurement settings, such as the measurement method or the antenna or target height before you start the measurement.

### Prompt for attributes

To make the attribute form appear when a point is stored for which there are required attributes but no value has yet been entered, tap **Options** and select **Prompt for attributes**.

**NOTE** – When **Prompt for attributes** is enabled:

- If you already entered attributes by tapping the **Attrib** softkey, you are not prompted for attributes.
- If attributes that are set as required are assigned a default value in the feature library, you are not prompted for attributes.

### Use attributes of base code

You can configure the Origin software to provide attributes for the complete code, or from a portion of the code – known as the "base code".

Typically, base codes are used when you use the + and - softkeys to "string" feature codes. For example, when you code a fence where all observations coded "Fence01" are joined together and all observations coded "Fence02" are joined together, and so on, and they all have the same attributes. In this example, you can create feature code libraries that contain all the "Fence\*\*" codes, or contain just the base code "Fence".

If you do string codes, and the feature library includes **only the base code**, then select the **Use attributes of base code** check box.

If you do not string codes, or if you do string codes but you include the entire code in the feature library, then you are not using base codes and you should clear the **Use attributes of base code** check box.

In the Origin software, you can use [Measuring and coding observations in one step, page 490](#) to create a code button that contains a numeric or alpha-numeric code (the base code) and then append a numeric suffix using the + and - softkeys.

**NOTE** – For codes entered into any other code field in the Origin software, you cannot use the + and - softkeys to append a suffix, so when you use base codes, the software can only attempt to determine the base code by stripping the numeric characters from the end of the codes.

The following rules help to explain the base code:

- When **Use attributes of base code** is **enabled**, the code **entered** on a button is the base code.  
Enter "Fence", string the code to become "Fence01", the attributes are derived from "Fence".
- When **Use attributes of base code** is **disabled**, the code **displayed** on a button is the base code.  
Enter "Fence", string the code to become "Fence01", the attributes are derived from "Fence01".
- If you edit or change the code on a button, the base code resets, using rule 1 or rule 2 above.

- If you change the configuration of the **Use attributes of base code** setting, the base code resets, using rule 1 or rule 2 above.
- When **Measure codes** passes the code to the **Measure topo** or **Measure points** screen, the base code from within **Measure codes** is retained.

**NOTE -**

- *If you use attributes and numeric codes with a string suffix, you must use Measure codes to define the suffix and start the measurement. Measure codes understands where the code ends and the suffix starts. If you do not use Measure codes, the entire numeric code + suffix will be treated as the code, the suffix cannot be determined, and attributes for the base code will not be available.*
- *You cannot string numeric only codes when **Use attributes of base code** disabled.*
- *If the **Use attributes of base code** check box is selected, it is applied throughout the software.*

Single tap to measure

Select the **Single tap to measure** check box to speed up your workflow and open the **Measure topo** or **Measure point** screen with a single tap of the appropriate code button. If the **Auto measure** check box in the **Options** screen is selected, the software will begin measuring the observation as soon as the **Measure topo** or **Measure point** screen opens.

Clear the **Single tap to measure** check box if you prefer to edit the code before measuring, for example when adding a string suffix or adding additional codes to the observation.

**NOTE -** *When the **Single tap to measure** check box is not selected, you must double-tap each code button to add the code to the **Code** field when the Multi-code button  is enabled.*

To measure and code observations

1. Tap  and select **Measure / Measure codes**.
2. Select the code group from the list or press A-Z to quickly switch to group pages 1-26.

**NOTE -** *You cannot use alphanumeric key shortcuts if the Multi-code button  at the bottom of the form is enabled.*

3. Tap the appropriate code button to select it or if the code button layout is 3x3 press the numeric key that corresponds to the appropriate code button.



You can also select code buttons using the keypad. Navigate to the button using the arrow keys, and then press the **Space** key.

If **Single tap to measure** is enabled In the **Options** screen, a single tap on any button will open the **Measure topo** or **Measure point** form. If **Single tap to measure** is **not** enabled, then unless the correct button is already highlighted you will need to tap the button twice or tap **Measure** to progress to the **Measure topo** or **Measure point** form. This extra tap gives you a chance to make other changes, for example to add a string suffix.

**TIP** – To apply multiple codes to the same observation, enable the **Multi-code** button  and then tap each code button. If **Single tap to measure** is not enabled, you must double-tap each code button to add the code. If you use multiple codes with attributes, enter all the codes **before** you enter the attributes.

4. If you are stringing codes, tap the **+** softkey to increment the suffix on the code.

To find the next available string for the currently highlighted button, tap **Find**. To configure the format of the suffix, tap **Options** and change the value in the **String suffix** field. (In portrait mode, swipe right to left along the row of softkeys to view the **Options** softkey.)

5. If required, tap **Measure** to progress to the **Measure topo** or **Measure point** screen.
6. Enter the point name and antenna or target height.
7. Select the measurement method.
8. Tap **Measure** to measure the point. For more information, refer to the topic for the selected measurement method.

**TIP** – To set the software to start subsequent measurements as soon as the **Measure topo** or **Measure point** screen appears, in the **Measure codes** screen tap **Options** and then select the **Auto measure** check box. **Auto measure** is temporarily paused when the method is set to **Distance offset, Angles only**, and **H Angle only**.

9. To store a note with an observation, tap . By default the note is attached to the previously measured point. To attach the note to the next point, tap **Next**.
10. If the measurement is not automatically stored, tap **Store**.

To change the auto store settings, tap **Options** in the **Measure topo Measure point** screen.

Once the measurement is stored, the **Measure codes** form appears, ready for the next measurement.

11. To measure a new point with the same code, tap **Enter**. Alternatively, repeat the steps above to measure a point with a different code.

**TIP –**

- The **Measure topo or Measure points** form remains open. To change the point name or the measurement method, tap ☰ and select the **Measure** form in the **Return to** list, make your changes, and then tap ☰ and select **Measure codes**.
- To measure a point with a null code, tap a blank code button.

## Stakeout

Use the **Stakeout** function to stake out points, lines, arcs, polylines, alignments, roads, and DTMs. To use stake out you must start a survey.

---

 **CAUTION** – Do not change the coordinate system or calibration after you have staked out items. If you do, the previously staked out points will be inconsistent with the new coordinate system and any points computed or staked out after the change.

---

To use GNSS for stake out, you must start an RTK survey. To stake out lines, arcs, polylines, alignments, or digital terrain models, you must define a projection and datum transformation.

You can stake out items that are already in the job, in a linked file, or by keying them in during stakeout. You can stake them out from the map, from the menu, or from a list you have created. To work from a list, see [Stake out items list, page 500](#).

### To stake out an item

1. To stake out from:
  - the map, select the item to be staked out in the map and tap **Stake out**.
  - the menu, tap  and select **Stakeout** and then select the item type to stake out. In the **Stake out** screen, select the item to stake out.

**TIP** – When selecting line, arc, or polyline features to stake out from the map, tap near the end of the feature that you want to designate as the start. Arrows are then drawn on the feature to indicate the direction. If the direction is incorrect, tap the feature to deselect it and then tap it at the correct end to reselect the feature in the direction required. Alternatively tap and hold in the map and select **Reverse direction** from the menu. If the feature has been offset, the offset directions are not swapped when the direction is reversed.

2. Navigate to the point, or to the point designated as the start of the feature. Alternatively, direct the person holding the pole with the target or prism to the point.

For detailed information on using the stakeout navigation feature, see [Stakeout navigation, page 503](#).

3. Mark the point.
4. Tap **Accept** to store the point.
5. If you selected the **View before storage** option, the staked deltas you selected in the **Stakeout options** screen are shown. Tap **Store** to store the deltas.

## Stake out items list

To work from a list of items to stake out, for example when staking a group of points, you must create a list of items to stake out, and then select a point from the **Stake out items** list and stake it out. Once you have stored the point, the software shows the **Stake out items** list. Select the next point to stake out.

You can update the **Stake out items** list by changing point selections in the map, when the **Stake out items** list is displayed on the right.

[To create the stake out list from the map](#)

1. In the map, select the items to be staked out. Tap **Stakeout**.
2. The **Stake out items** list shows the items selected for stakeout. To add more items to the list, do one of the following:
  - Select them on the map. The **Stake out items** list is updated as you select them. Tap **OK**.
  - Tap **Add**. Select the method you want to use [to add points to the list](#).

The items you selected are shown in the **Stake out items** list.

**TIP** – When selecting line, arc, or polyline features to stake out from the map, tap near the end of the feature that you want to designate as the start. Arrows are then drawn on the feature to indicate the direction. If the direction is incorrect, tap the feature to deselect it and then tap it at the correct end to reselect the feature in the direction required. Alternatively tap and hold in the map and select **Reverse direction** from the menu. If the feature has been offset, the offset directions are not swapped when the direction is reversed.

### To create the stake out list from the menu

1. Tap  and select **Stakeout / Points**.
2. If the map is not shown and the **Stake out point** form is full-width, tap **List**.

The **Stake out items** list shows all items selected for stake out. The list may already contain points that were added to the list previously but not staked out.

3. Tap **Add**. Select the method you want to use [to add points to the list](#).

The points you selected are shown in the **Stake out items** list.

### To create the stake out list from a file outside the job

To select points in a CSV/TXT file or another job that is not linked to the current job:

1. Tap  and select **Stakeout / Points**.
2. If the map is not shown and the **Stake out point** form is full-width, tap **List**.
3. Tap **Add**.
4. Tap **Select from file**.
5. Tap the file to select it or use the controller arrow keys to select the file. Tap **Accept**.
6. If the **Advanced geodetic** check box is enabled in the **Cogo settings** screen, and you select a CSV or TXT file, you must specify the **Coordinate type** of the points in the file. Select **Grid points** or **Grid (local) points**.
7. If the points in the file are **Grid (local) points**, select the transformation to use to transform them to grid points:
  - To assign the transformation later, select **Not applied, this will be defined later**. Tap **Accept**.
  - To create a new display transformation, select **Create new transformation**. Tap **Next** and complete the required steps. See [Transformations, page 261](#).
  - To select an existing display transformation, select **Select transformation**. Select the display transformation from the list. Tap **Accept**.

8. To select the points from the file to add to the stakeout list, tap each point name or tap **All**.

**NOTE** – Points in the CSV/TXT/JOB file that are already in the stake out list do not appear and cannot be added again to the list.

9. Tap **Add**.

The points you selected are shown in the **Stake out items** list.

#### Managing the list of Stake out items

If you select more than one item in the map and then tap **Stakeout**, the **Stake out items** list appears. Select each item in turn from the **Stake out items** list, navigate to it and stake it out before returning to the **Stake out items** list.

**TIP** – Points are automatically removed from the list after they have been staked. To keep points in the list, clear the **Remove staked point from list** check box in the [stakeout options](#) screen. This setting does not affect line, arc, or polyline features.

When the **Stake out items** list is shown alongside the map:

- The currently selected list item is highlighted on the map.
- Changing the items that are selected in the map updates the items in the **Stake out items** list, and removing items in the **Stake out items** list updates what is selected in the map.
- To clear the **Stake out items** list, tap **Rem all** or double-tap in the map. If you accidentally clear the list, tap **Undo** to restore the list of **Stake out items**.

To set aside the **Stake out items** list tap **Esc**. The **Stake out items** list is remembered and you can return to it later.

When the **Stake out items** list is not open:

- To clear the current map selection, double-tap in the map.
- Select items in the map as usual to perform other functions, for example to key in features or compute Cogo calculations.
- To return to the **Stake out items** list, tap **Stakeout**.
- To add the current map selection to the current **Stake out items** list, tap and hold in the map and select **Stakeout: x items**, where **x** is the count of the items in the stakeout list as well as the number of items in the map. The **Stake out items** list opens, showing the updated list.

## Stakeout navigation

When navigating to a point during stakeout, the information shown depends on whether you are performing a Conventional or GNSS survey, and the options you have configured in the **Stakeout options** screen. To configure these options, see [Stakeout navigation display, page 504](#).

### Conventional survey

1. Hold the display screen in front of you as you walk forwards in the direction that the arrow is pointing. The arrow points in the direction of the point that you intend to measure (the "target"). The navigation deltas appear at the bottom of the screen, and indicate the distance to and direction of the target. To change the displayed deltas, tap **Options**.
2. When you get to within 3 meters (10 feet) of the point, the arrow disappears, and the in/out and left/right directions appear, with the instrument as a reference point.

If you are operating a robotic instrument remotely from the target:

- the instrument automatically tracks the prism as it moves
- the instrument continuously updates the graphical display
- the graphical display is reversed and the arrows are shown from the target (prism) to the instrument

The first display shows which way the instrument should be turned, the angle that the instrument should display and the distance from the last point staked to the point currently being staked.

3. Turn the instrument (two outline arrows will appear when it is on line), and direct the person holding the pole on line.

If you are using a servo instrument, and the **Servo auto turn** field in the survey style is set to **HA & VA**, or **HA only** the instrument automatically turns to the point. If you are working robotically, or when the **Servo auto turn** field in the survey style is set to **Off**, the instrument does not turn automatically.

4. Stake the point.

## GNSS survey

1. Hold the display screen in front of you as you walk toward the point that you intend to stake (the "target"). The navigation deltas appear at the bottom of the screen, and indicate the distance to and direction of the target. To change the displayed deltas, tap **Options**.

If you are using GNSS only:

- The large navigation arrow points in the direction of the point that you intend to measure (the "target"). You must be moving for the navigation arrow to show the correct direction.
- The horizontal deltas apply to the antenna phase center (APC). You must keep the pole vertical as you navigate to the feature.

**TIP** – To change the reference point used by the small orientation arrow, tap the **North/Sun** softkey. (In portrait mode, swipe right to left along the row of softkeys to view more softkeys.)

2. When you get to within 10 feet (3 meters) of the point, the arrow disappears and a bull's-eye target appears. When staking a point, line, arc, or alignment a grid appears as you near the target. The grid changes scale as you move closer to the target.

Keep facing in the same direction and only move forwards, backwards, left or right. Do not change your orientation.

3. Continue moving forwards until the cross, representing your current position, covers the bull's-eye target, representing the point.
4. Stake the point.

## Stakeout navigation display

The information shown when navigating to points during stakeout depends on whether you are performing a Conventional or GNSS survey, and the options you have configured in the **Stakeout options** screen. Configure these options in the survey style or tap **Options** during stakeout.

### Conventional surveys

1. Tap **≡** and select **Settings / Survey styles / <Style name> / Stakeout** to configure the stakeout display in the survey style.

**TIP** – To change the deltas during stakeout, tap **Options** in the stakeout screen.



2. Use the **Display** group to configure the appearance of the navigation display during stakeout:
  - a. To show the large navigation arrow in the navigation screen, set the **Show stakeout graphics** switch to **Yes**.

**TIP** – If you are using a controller with a smaller screen, or you want to fit more navigation deltas on the screen, set the **Show stakeout graphics** switch to **No**. The other fields in the **Display** group are hidden when the switch is set to **No**.

- b. Select the **Display mode**: The options are:
  - **Direction and distance** – the stakeout navigation display shows a large arrow pointing in the direction you have to move. When you are close to the point, the arrow changes to the in/out and left/right directions, relative to the instrument.
  - **In/out and left/right** – the stakeout navigation display shows in/out and left/right directions.

**TIP** – By default the software automatically gives in/out and left/right directions from the **Target perspective** in a robotic survey, and from the **Instrument perspective** when connected to a servo instrument using a face plate or cable. To change this, change the settings in the **Servo/Robotic** group box. For more information, see [Servo/Robotic, page 281](#).

- c. Use the **Distance tolerance** field to specify the allowable error in distance. If the target is within this distance from the point, the software indicates that the distance is correct.
- d. Use the **Angle tolerance** field to specify the allowable error in angle. If the conventional instrument is turned away from the point by less than this angle, the software indicates that the angle is correct.
- e. Use the **Grade** field to display the grade of a slope as an angle, percent, or ratio. The ratio can be displayed as **Rise:Run** or **Run:Rise**. See [Grade, page 91](#).
- f. When staking position relative to a road, from the **Design cut/fill** field, select whether to show the **Vertical** or **Perpendicular** cut/fill to the design.

**NOTE** – The **Perpendicular** cut/fill position is drawn on the design in the cross section view. Because the cross section view is not drawn to scale, the perpendicular position may appear slightly incorrect (ie. not exactly perpendicular).

**TIP** – For all other stakeout methods the **Vertical** cut/fill to the design is always shown.

3. In the **Deltas** group, review the deltas shown for the current stakeout entity. To change the deltas shown, tap **Edit**.

Deltas are the information fields showing during navigation that indicate the direction and distance you need to travel to the entity you want to stake out. See [Stakeout navigation deltas, page 508](#).

4. To display the cut or fill relative to a DTM during stakeout, in the **DTM** group box select the DTM file. If required, in the **Offset to DTM** field, specify an offset to the DTM. Tap  and select whether the offset is to be applied vertical or perpendicular to the DTM. The **V.Dist DTM** value is to the offset position.
5. If your Spectra Geospatial controller includes an internal compass, you can use it when staking out a position or navigating to a point. To use the internal compass, select the **Compass** check box. Spectra Geospatial recommends you **disable** the compass when you are near magnetic fields that may cause interference.

### GNSS surveys

1. Tap  and select **Settings / Survey styles / <Style name> / Stakeout** to configure the stakeout display in the survey style.

**TIP** – To change the deltas during stakeout, tap **Options** in the stakeout screen.

2. Use the **Display** group to configure the appearance of the navigation display during stakeout:
  - a. To show the large navigation arrow in the navigation screen, set the **Show stakeout graphics** switch to **Yes**.

**TIP** – If you are using a controller with a smaller screen, or you want to fit more navigation deltas on the screen, set the **Show stakeout graphics** switch to **No**. The other fields in the **Display** group are hidden when the switch is set to **No**.

- b. Select the **Display mode**: The options are:
- **Target centered** – the selected point stays fixed in the center of the screen
  - **Surveyor centered** – your position stays fixed in the center of the screen
- c. Choose a setting in the **Display orientation** field. The options are:
- **Direction of travel** – the screen will orientate so that the top of the screen points in the direction of travel.
  - **North / Sun** – the small orientation arrow shows the location of North or the sun. The screen will orientate so that the top of the screen points toward North or the sun. When using the display, tap the **North/Sun** softkey to toggle the orientation between north and the sun.
  - **Reference azimuth**:
    - For a point the screen will orientate to the **Reference azimuth** for the job. The **Stake** option must be set to **Relative to azimuth**.
    - For a line or road the screen will orientate to the azimuth of the line or road.

**NOTE** – If, when staking a point, the **Display orientation** is set to **Reference azimuth** and the **Stake** option is **not** set to **Relative to azimuth** the display orientation behavior will default to **Direction of travel**. For Stake options, see [GNSS stake methods, page 517](#).

- d. Use the **Grade** field to display the grade of a slope as an angle, percent, or ratio. The ratio can be displayed as **Rise:Run** or **Run:Rise**. See [Grade, page 91](#).
- e. When staking position relative to a road, from the **Design cut/fill** field, select whether to show the **Vertical** or **Perpendicular** cut/fill to the design.

**NOTE** – The **Perpendicular** cut/fill position is drawn on the design in the cross section view. Because the cross section view is not drawn to scale, the perpendicular position may appear slightly incorrect (ie. not exactly perpendicular).

**TIP** – For all other stakeout methods the **Vertical** cut/fill to the design is always shown.

3. In the **Deltas** group, review the deltas shown for the current stakeout entity. To change the deltas shown, tap **Edit**.

Deltas are the information fields showing during navigation that indicate the direction and distance you need to travel to the entity you want to stake out. See [Stakeout navigation deltas, page 508](#).

4. To display the cut or fill relative to a DTM during stakeout, in the **DTM** group box select the DTM file. If required, in the **Offset to DTM** field, specify an offset to the DTM. Tap  and select whether the offset is to be applied vertical or perpendicular to the DTM. The **V.Dist DTM** value is to the offset position.
5. If your Spectra Geospatial controller includes an internal compass, you can use it when staking out a position or navigating to a point. To use the internal compass, select the **Compass** check box. Spectra Geospatial recommends you *disable* the compass when you are near magnetic fields that may cause interference.
6. By default the software displays navigation information to the point from your current position. To navigate using a cross-track line between the point to be staked out and a reference point, change the **Stake** method. See [GNSS stake methods, page 517](#).

### Stakeout navigation deltas

The navigation information displayed during stakeout is user-definable and different configurations can be set up for the following item types:

- Points
- Points on a line, arc, polyline, or road
- Line, arc, polyline, or road
- Surface

#### To edit the stakeout deltas

1. Tap  and select **Settings / Survey styles / <Style name> / Stakeout** to configure the survey style to display the stakeout deltas as you usually use them.

**TIP** – To change the deltas during stakeout, tap **Options** in the stakeout screen or tap and hold in the navigation pane.

2. In the **Deltas** group, tap **Edit**.
3. In the **Deltas** list, tap a delta to change whether the delta is displayed. A check mark indicates the delta will be shown. When fewer deltas are shown they are displayed in a larger font.
4. To reorder the deltas, tap and hold a delta and drag it up or down the list.
5. Tap **Accept**.
6. If you are using a controller with a smaller screen, or you want to fit more navigation deltas on the screen, set the **Show stakeout graphics** switch to **No**.
7. Tap **Accept** to return to the **Stakeout** screen.

#### Available deltas

##### Deltas: Points

Available deltas for points are:

- Go North/South
- Go East/West
- Go Left/Right
- Go Forward/Backward
- Go In/Out (conventional surveys only)
- Delta H.Ang (conventional surveys only)
- Go Left/Right (angle) (conventional surveys only)
- H.Ang reqd. (conventional surveys only)
- Elevation
- V.Distance
- Design elevation
- Azimuth

## Stakeout

- H.Distance
- Northing
- Easting
- DTM elevation
- V. Distance DTM

### Deltas: Points on a line, arc, polyline, or road

Available deltas for points on a line, arc, polyline, or road are the same as for a line, arc, polyline, or road, with the addition of:

- Go Forward/Backward Relative to line
- Side slope
- Fill slope (as staked)
- H.Distance to hinge point
- V.Distance to hinge point
- S.Distance to hinge

### Deltas: Line, arc, polyline, or road

Available deltas for a line, arc, polyline, or road are the same as for points, with the addition of:

- Go Left/Right Relative to line
- Station
- H.Offset
- Grade to line
- Station: Reference alignment
- H.Offset: Reference alignment

## Deltas: Surface

Available deltas for surfaces are:

- Northing
- Easting
- Elevation
- V.Distance
- Design elevation

## As-staked point details

**As-staked point details** are shown in stakeout reports generated from the **Export** screen, and they are shown on the **Confirm staked deltas** screen that appears when you enable **View before storage**.

To configure **As-staked point details**:

- When editing the survey style, tap  and select **Settings / Survey styles / <Style name> / Stakeout**.
- During stakeout, tap **Options**.

The **As-staked point details** group box has the following settings.

## View before storage and horizontal tolerance

To see the differences between the design point and the as-staked point before you store the point, select the **View before storage** check box and then choose one of these options:

- To see the differences every time, set the **Horizontal tolerance** to 0.000 m.
- To see the differences only if the tolerance is exceeded, set the **Horizontal tolerance** to a suitable value.

**NOTE** – The **Stake delta** values are reported as differences **from** the measured/as-staked point **to** the design point.

## Staked deltas format

From the **Staked deltas format** field, select an appropriate display format.

### General Survey stakeout formats

The following list shows the translated stakeout formats that are supplied with the language files, and the support offered by those formats:

- **Point – Stake markup**

Provides a simplified stakeout display that presents the vertical distance (cut/fill) to the design point. The vertical distance to a DTM will also be displayed if applicable.

- **Point – Stake multiple elevs**

Provides a stakeout display that allows you to edit the point design elevation (the cut/fill value will be updated) and entry of up to two extra design elevations with associated vertical offsets and updated cut/fill values.

- **Line – Stake markup**

Provides a simplified stakeout display that presents the vertical distance (cut/fill) to the design position. The appropriate station and offset values are reported, based on the selected line stakeout method.

- **Arc – Stake markup**

Provides a simplified stakeout display that presents the vertical distance (cut/fill) to the design position. The appropriate station and offset values are reported, based on the selected arc stakeout method.

- **DTM – Stake markup**

Provides a simplified stakeout display that presents the vertical distance (cut/fill) to the DTM being staked.

- **Stake manhole inverts**

When staking a manhole with multiple inverts from a pipe network LandXML file, provides a simplified stakeout display that uses the extra invert elevations in the LandXML pipe network file to compute their associated vertical offsets and updated cut/fill values on the **Confirm staked deltas** screen.



### Roads stakeout formats

If the Roads application is installed, the following additional translated stakeout formats are available:

- **Road – Catch + offsets**

Provides details of all the standard road staked deltas plus a list of the horizontal and vertical distances to each of the cross-section positions from the staked offset position. The reported horizontal and vertical distances include the applied horizontal and vertical construction offsets.

- **Road – Stake markup**

Provides a simplified stakeout display that presents the vertical distance (cut/fill) to the road design position. Appropriate station and offset values and cross-section details (in the case of catch point staking) are reported, based on the road stakeout method.

- **Road – XS details**

Provides all the standard road staked deltas details as well as a list of the cross-section elements (left and right) that define the design cross-section at the selected station.

### As-staked name and as-staked code

You can set the name of the As-staked point to be one of the following:

- **Design name**
- **Design name (with prefix)**
- **Design name (with suffix)**
- the next **Auto point name**

For the design name options that have a prefix or suffix, complete the **Prefix/Suffix** field as required.

**NOTE** – *The design name options are available only when staking points.*

You can also set the code of the As-staked point to be one of the following:

- **Design name**
- **Design code**
- **Last code used**

- **Design station and offset**
- **Design file attributes**

Select **Design file attributes** if you are staking an item in a DXF, Shape, LandXML or IFC file and want to save the design file attributes for the selected item with the as-staked point.

The **Description** defaults as follows:

- When staking a point, line or arc with descriptions, the description of the as-staked point will default to the description of the design entity unless the **As-staked** code is set to **Last code used** in which case the last used description is used.
- When staking a road using the Roads application, the description will always be the last used independent of the **As-staked code** setting.

#### Store grid deltas

Set the **Store grid deltas** check box. Do one of the following:

- Select the check box to display and store the delta northing, delta easting, and delta elevation during stakeout.
- Clear the check box to display and store the deltas as a horizontal distance, vertical distance, and azimuth.

**NOTE** – *If you use a user definable stakeout report, the **Store grid deltas** option is not used, unless it is referenced in your report.*

## To stake out points

You can stake a single point or group of points from the map, or from the menu.

Before you start, configure your [navigation display settings](#). You can stake [relative to a DTM](#) or [the design elevation](#), if required.

When navigating to the point, you can navigate to and stake a new point defined by an azimuth and offset from the selected point, if required.

### To stake a single point from the map

#### Conventional survey

1. Make sure the **Target height** is correct.



To change the target height, tap the target icon in the status bar and edit the height of the target. Tap **Accept**.

2. Tap the point in the map and then tap **Stakeout**. Alternatively, double-tap the point.
3. [Navigate to the point](#).
4. When the point is within tolerance, tap **Measure** to measure the point.
5. Tap **Accept** to store the point.
6. If you selected the **View before storage** option, the staked deltas you selected in the **Stakeout options** screen are shown. Tap **Store**.

#### GNSS survey

1. Make sure the **Antenna height** and **Measured to** information is correct.
2. Tap the point in the map and then tap **Stakeout**. Alternatively, double-tap the point.
3. [Navigate to the point](#).
4. When the point is within tolerance, measure the point.
5. Tap **Store**.
6. If you selected the **View before storage** option, the staked deltas you selected in the **Stakeout options** screen are shown. Tap **Store**.

### To stake a single point from the Stakeout menu

1. Tap  and select **Stakeout / Points**.
2. If the **Stake out items** list appears beside the map, tap **Point** to change to staking a single point.
3. Tap  next to the **Point name** field and select:
  - **List** to view a list of all points in the current job and linked files.
  - **Wildcard search** to select from a filtered list of all points in the current job and linked files.
  - **Key in** to key in the coordinates of the point to stake.

**TIP** – Tap **Closest** to populate the **Point name** field with the name of the closest point. (In portrait mode, swipe right to left along the row of softkeys to view more softkeys.) **Closest** searches the current job and all linked files to find the closest point that is *not* an as-staked point or a design point for the as-staked points.

4. Enter the **Point increment value**. After measuring and storing the point, the software uses the **Point increment** value to determine the next point to stake. To:
  - Return to the stake out point screen after staking a point, enter an increment of 0 or ?.
  - Automatically increment to the next point, enter a valid increment value.

If a point does not exist using the increment specified, tap **Cancel** to return to this screen after staking a point. Alternatively, tap the **Search** button to find the next available point.

You can use a decimal point increment, for example 0.5. You can also increment the numeric component of a point name that ends in alpha characters, for example, you can increment 1000a by 1 to 1001a. To do this, tap  and then clear the **Apply to numeric only** check box.

5. Navigate to the point and stake it. Refer to the steps in the [To stake a single point from the map, page 515](#) section above.
6. The software uses the **Point increment** value to determine the next point to stake. If a point with the increment value exists, the name and navigation information for the next point are shown.

If the point does not exist, the **Stake out point** screen appears. Select the next point to stake. Tap **Next** to find the next point. If it does not exist, tap the **Search** button to find the next available point.

**TIP** – When staking a single point, you can still use a stake point list to ensure that you stake all required points. To do this, build the stake list, make sure that **Remove staked point from list** is enabled, and stake points using the stake a single point mode. As points are staked they will be removed from the stake list. Tap **List** as required to check which points still need to be staked.

### To edit the design elevation

When navigating to a point during stakeout, the design elevation is shown at the bottom of the **Stake out point** form. To edit the elevation, tap ► and enter a new value. To revert to the original elevation, tap ► and select **Reload original elevation**.

After staking, you can modify the design elevation in the as-staked deltas screen, depending on the [stake out style sheet](#) being used.

### GNSS stake methods

In a GNSS survey, configure the stake method to control how stake out navigation information appears. The default method is **To the point**, where directions to the point are given from your current position.

To change the GNSS stake method:

1. Make sure you have entered an antenna height.
2. Tap ☰ and select **Stakeout / Points**.
3. If the **Stake out point** form appears beside the map showing a list, tap **Point** to change to staking a single point.
4. Tap **Options**.
5. In the **Stake** field, select the method. Select from:
  - **To the point** – stake out the point with directions from your current position. This is the default method.
  - **From fixed point** – stake out the point with cross-track information and directions from another point. Enter a point name in the **From point** field. Select from a list, key in, or measure this value.

- **From start position** – stake out the point with cross-track information and directions from the current position when you start to navigate.
- **From last point staked** – stake out the point with cross-track information and directions from the last point that was staked out and measured. The **staked** point is used, not the design point.
- **Relative to azimuth** – stake out the point with the cross-track information and directions relative to the **Reference azimuth**.

The **Reference azimuth** field shows the value entered in the **Reference azimuth** field of the **Cogo settings** screen of the job properties (see [Cogo settings, page 99](#)). Editing the **Reference azimuth** field in the **Stakeout Options** screen updates the **Reference azimuth** field in the **Cogo settings** screen and the **Map settings** screen.

#### **NOTE –**

- *The cross-track function creates a line between the point to be staked out and one of the following: a fixed point, the start position, the last point staked, or a reference azimuth. The Origin software displays this line, and an extra field (**Go left** or **Go right**) gives the offset to the line.*
- *When the **Deltas** field is set to Station and offset the **Go left** or **Go right** field shows the same information as the **H.Offset** field.*
- *When the **Deltas** is set to Station and offset and the **Stake** method is set to Relative to azimuth, the **Go left** or **Go right** field is replaced by the **delta Elev (to last)** staked point field.*

#### To stake an offset point

When staking a point using the default [GNSS stake method](#) **To the point** you can stake an offset point defined by an azimuth and offset from the point.

You can also define a second offset point on the same azimuth as the first offset point.

1. When navigating to the point, tap **Offset**.
2. Use the fields in the **Offset** screen to configure staking out points (1) at an azimuth (2) from a point (3) and offset by a horizontal distance (4).

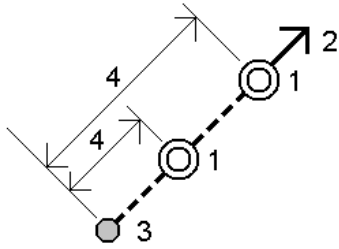

The elevation for each offset point can be defined by:

- **Slope from point** – the elevation is computed by a slope from the elevation of the point selected to stake.
- **Delta from point** – the elevation is computed by a delta from the elevation of the point selected to stake.
- **Key in** – the elevation is keyed in.

**NOTE** – If the point has no elevation, the elevation for the offset points must be keyed in.

3. Tap **Accept**.

The map shows the selected point and the first offset point.

4. Navigate to the offset point. See [Stakeout navigation, page 503](#).

5. When the point is within tolerance, measure the point. Tap **Store**.

If you have defined a second point, it is shown on the map.

6. Navigate to the second offset point.

7. When the point is within tolerance, measure the point. Tap **Store**.

If you are staking points from a list, the software returns to the stakeout point list.

## To stake out a line

Before you start, configure your [navigation display settings](#). You can stake [relative to a DTM](#) or [the design elevation](#), if required.

1. To select the line:

- From the map, you can:
  - Select the line and tap **Stakeout**.
  - Select the two points that define the line, and then tap and hold in the map and select **Stake out line**.
  - Double-tap the line in the map.

**TIP** – When selecting a line to stake out from the map, tap near the end of the line that you want to designate as the start. Arrows are then drawn on the line to indicate the direction. If the direction is incorrect, tap the line to deselect it and then tap it at the correct end to reselect the line in the direction required. Alternatively tap and hold in the map and select **Reverse line direction** from the menu.

**NOTE** – *If the line has been offset, the offset directions are not swapped when the line direction is reversed.*

- From the menu, tap ☰ and select **Stakeout / Lines**. Tap ► next to the **Line name** field and select:
  - **List** to view a list of previously defined lines to select from.
  - **Two points** to define the line from two points.
  - **Azimuth** to define the line by a start point and an azimuth.

2. In the **Stake** field, select the method and then fill out the required fields. Refer to the [Line stakeout methods, page 521](#) below.

To select the station to stake, key it in, tap the **Sta-** and **Sta+** softkeys, or tap ► next to the **Station** fields to select the start or end station.



When staking a station or staking to the line you can tap another station or line in the map to change what you are staking, and the stakeout details in the adjacent panel update to reflect the new selection.

3. To review the line definition, tap **Details**.
4. Enter the **Antenna height** or **Target height**, the value of the station to be staked out (if any), and any further details, such as horizontal and vertical offsets.
5. Tap **Start**.
6. [Navigate to the point](#).
7. When the point is within tolerance, tap **Measure** to measure the point.
8. Tap **Accept** to store the point.
9. If you selected the **View before storage** option, the staked deltas you selected in the **Stakeout options** screen are shown. Tap **Store**.
10. The software returns to the navigation screen or, if you selected multiple items to stake out, the software returns to the **Stake out items** list.

### Line stakeout methods

#### To the line

Measure your position **(1)** relative to a defined line **(2)**.

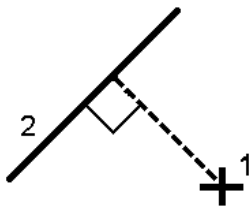

### Distance along line

Stake out the distance along a defined line **(1)** at the distance interval **(2)**. The distance and distance interval values are **slope** distances along the line, rather than **horizontal** distances. This method also enables positions on a vertical line to be staked.

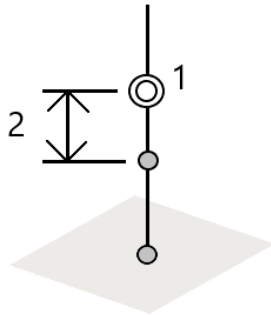

### Station on the line

Stake out stations **(1)** on a defined line at the station interval **(2)** along the line.

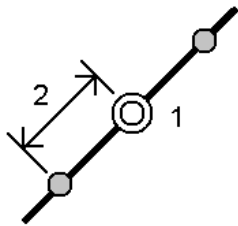

### Station/offset from line

Stake out a point **(1)** perpendicular to a station **(3)** on a defined line **(2)** and offset to the left or right by a horizontal distance **(4)**. The design elevation of the point is the same as the elevation of the line at the selected station.

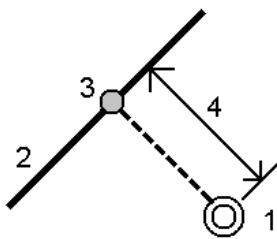

**TIP** - You can also apply a vertical offset.

### Slope from line

Measure your position relative to a slope **(2)** defined either side of a defined line **(1)**. Each slope can be defined with a different grade **(3)**.

Use the **Slope left** field and the **Slope right** field to define the type of grade in one of the following ways:

- horizontal and vertical distance
- grade and slope distance
- grade and horizontal distance

The software reports your position relative to the line and the vertical distance as a cut **(4)** or a fill **(5)** to the slope.

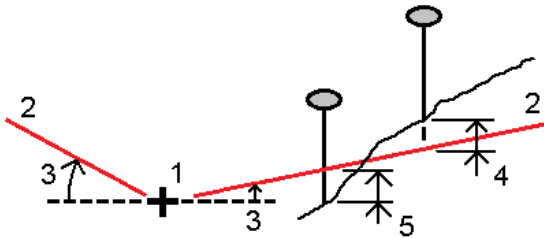

### Station/skew offset from line

Stake out a point **(1)** at a skew **(2)** from a station **(3)** on a defined line **(4)** and offset to the left or right by a skew distance **(5)**. The skew can be defined by a forward or backward delta angle to a line **(6)** at right angles to the line being staked, or the skew can be defined by an azimuth. The diagram shows a point defined by a skew forward and offset to the right.

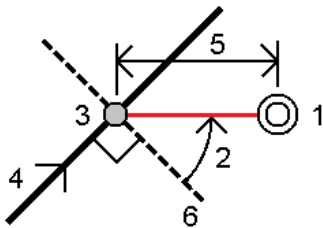

The elevation for the point can be defined by:

- **Slope from line** – the elevation is computed by a slope from the elevation of the line at the entered station
- **Delta from line** – the elevation is computed by a delta from the elevation of the line at the

entered station.

- **Key in** – the elevation is keyed in.

**NOTE** – If the line has no elevation, the elevation for the point must be keyed in.

## To stake out a polyline

Polylines are two or more lines or arcs connected together. If required, you can create a polyline from existing points in the map. See [To key in a polyline, page 220](#).

Before you start, configure your [navigation display settings](#). You can stake [relative to a DTM](#) or [the design elevation](#), if required.

1. To select the polyline:

- From the map, you can:
  - Select the polyline and tap **Stakeout**.
  - Double-tap the polyline in the map.

**TIP** – When selecting a polyline to stake out from the map, tap near the end of the polyline that you want to designate as the start. Arrows are then drawn on the polyline to indicate the direction. If the direction is incorrect, tap the polyline to deselect it and then tap it at the correct end to reselect the polyline in the direction required. Alternatively tap and hold in the map and select **Reverse polyline direction** from the menu.

**NOTE** – If the polyline has been offset, the offset directions are not swapped when the polyline direction is reversed.

- From the menu, tap ☰ and select **Stakeout / Polylines**.

2. In the **Stake** field, select the method and then fill out the required fields. Refer to the [Polyline stakeout methods, page 525](#) below.

To select the station to stake, key it in, tap the **Sta-** and **Sta+** softkeys, or tap ► next to the **Station** fields to select a station from the list.

**TIP** – When staking a station or staking to the polyline you can tap another station or polyline in the map to change what you are staking, and the stakeout details in the adjacent panel update to reflect the new selection.

3. To review the polyline definition, tap **Details**.
4. Enter the **Antenna height** or **Target height**, the value of the station to be staked out (if any), and any further details, such as horizontal and vertical offsets.
5. Tap **Start**.
6. [Navigate to the point](#).

**NOTE** – The **Relative to polyline** navigation deltas are derived by projecting from your current position perpendicular to the polyline to compute the **Go Right/Go Left** value, with the **Go Forward/Go Backward** value computed from that station along the polyline to the target station.

7. When the point is within tolerance, tap **Measure** to measure the point.
8. Tap **Accept** to store the point.
9. If you selected the **View before storage** option, the staked deltas you selected in the **Stakeout options** screen are shown. Tap **Store**.
10. The software returns to the navigation screen or, if you selected multiple items to stake out, the software returns to the **Stake out items** list.

### Polyline stakeout methods

#### To the polyline

Measure your position **(1)** relative to a defined polyline **(2)**.

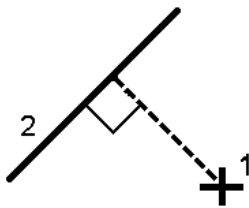

### Distance along polyline

Stake out the distance along a defined polyline **(1)** at the distance interval **(2)**. The distance and distance interval values are **slope** distances along the polyline, rather than **horizontal** distances. This method also enables positions on a vertical polyline to be staked.

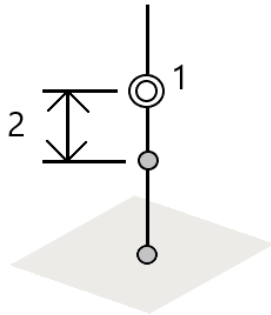

### Station on the polyline

Stake out stations **(1)** on a defined polyline at the station interval **(2)** along the polyline.

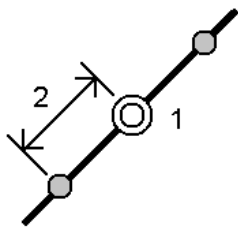

### Station/offset from polyline

Stake out a point **(1)** perpendicular to a station **(3)** on a defined polyline **(2)** and offset to the left or right by a horizontal distance **(4)**. The design elevation of the point is the same as the elevation of the polyline at the selected station.

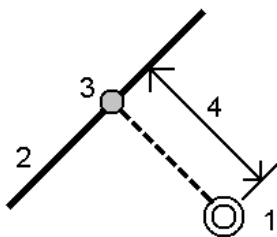

**TIP** - You can also apply a vertical offset.

### Slope from polyline

Measure your position relative to a slope **(2)** defined either side of a defined polyline **(1)**. Each slope can be defined with a different grade **(3)**.

Use the **Slope left** field and the **Slope right** field to define the type of grade in one of the following ways:

- horizontal and vertical distance
- grade and slope distance
- grade and horizontal distance

The software reports your position relative to the polyline and the vertical distance as a cut **(4)** or a fill **(5)** to the slope.

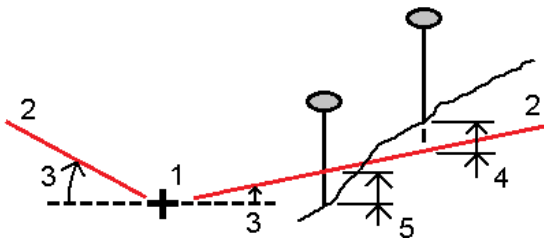

### Station/skew offset from polyline

Stake out a point **(1)** at a skew **(2)** from a station **(3)** on a defined polyline **(4)** and offset to the left or right by a skew distance **(5)**. The skew can be defined by a forward or backward delta angle to a polyline **(6)** at right angles to the polyline being staked, or the skew can be defined by an azimuth. The diagram shows a point defined by a skew forward and offset to the right.

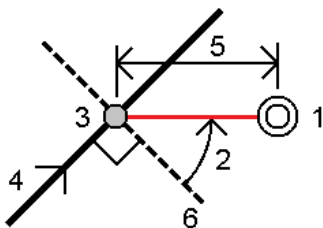

The elevation for the point can be defined by:

- **Slope from polyline** – the elevation is computed by a slope from the elevation of the polyline at the entered station
- **Delta from polyline** – the elevation is computed by a delta from the elevation of the polyline at

the entered station.

- **Key in** – the elevation is keyed in.

**NOTE** – If the polyline has no elevation, the elevation for the point must be keyed in.

### Side slope from polyline

1. To define the hinge, select a **Hinge derivation** method and then complete the appropriate fields:

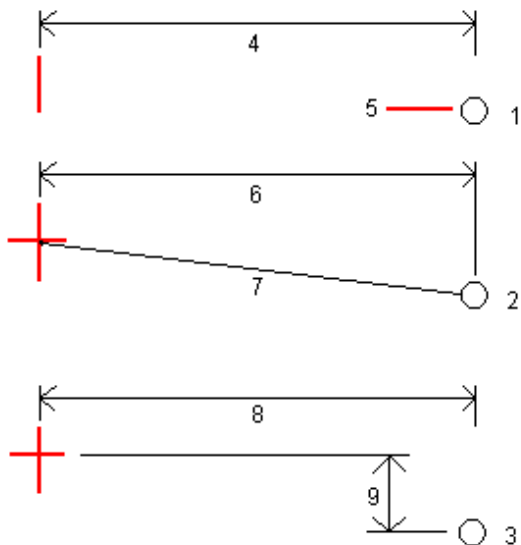

**1 – Offset and elevation.** Enter an offset (**4**) from the polyline, and the elevation (**5**) of the hinge position.

**2 – Offset and slope.** Enter an offset (**6**) from the polyline, and the slope value (**7**) from the polyline to the hinge position.

**3 – Offset and vertical distance.** Enter an offset (**8**) from the polyline, and the vertical difference (**9**) from the polyline to the hinge position.

**NOTE** – If the polyline is defined by points with no elevations, the only hinge derivation method available is **Offset and elevation**.

2. To define the side slope:

Enter the **Cut slope (1)**, **Fill slope (2)**, and **Cut ditch width (3)** values.



**NOTE** – Cut and fill slopes are expressed as positive values. You cannot add a string after a side slope.



To define a side slope with only a cut or fill slope, leave the other slope value field as '?'.



## To stake out an arc

Before you start, configure your [navigation display settings](#). You can stake [relative to a DTM](#) or [the design elevation](#), if required.

1. Do one of the following:

- Tap  and select **Stakeout / Arcs** and then tap  next to the **Arc name** field to view a list of previously defined arcs to select from.
- In the map, select the arc to be staked out. Tap **Stakeout**.

**TIP** – When selecting an arc to stake out, tap near the end of the arc that you want to designate as the start. Arrows are then drawn on the arc to indicate the direction. If the direction of the arc is incorrect, tap the arc to deselect it and then tap it at the correct end to reselect the arc in the direction required. Alternatively tap and hold in the map and select **Reverse arc direction**.

**NOTE** – If the arc has been offset, the offset directions are not swapped when the arc direction is reversed.

2. In the **Stake** field, select the method and then fill out the required fields. Refer to the [Arc stakeout methods, page 530](#) below.

To select the station to stake, key it in, tap the **Sta-** and **Sta+** softkeys, or tap  next to the **Station** fields to select the start or end station.

**TIP** – When staking a station or staking to the arc you can tap another station or arc in the map to change what you are staking, and the stakeout details in the adjacent panel update to reflect the new selection.

3. To review the arc definition, tap **Details**.
4. Enter the **Antenna height** or **Target height**, the value of the station to be staked out (if any), and any further details, such as horizontal and vertical offsets.
5. Tap **Start**.
6. [Navigate to the point](#).
7. When the point is within tolerance, tap **Measure** to measure the point.
8. Tap **Accept** to store the point.
9. If you selected the **View before storage** option, the staked deltas you selected in the **Stakeout options** screen are shown. Tap **Store**.
10. The software returns to the navigation screen or, if you selected multiple items to stake out, the software returns to the **Stake out items** list.

### Arc stakeout methods

#### To the arc

Measure your position **(1)** relative to a defined arc **(2)**.

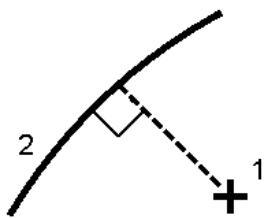

## Stakeout

### Station on the arc

Stake out points **(1)** on a defined arc at the station intervals **(2)** along the arc.

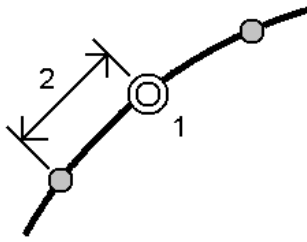

### Station/offset from arc

Stake out a point **(1)** perpendicular to a station **(3)** on a defined arc **(2)** and offset to the left or right by a horizontal distance **(4)**.

The design elevation of the point is the same as the elevation of the arc at the selected station.

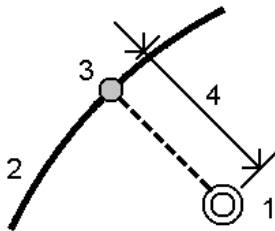

### Slope from arc

Measure your position relative to a slope **(2)** defined either side of a defined arc **(1)**. Each slope can be defined with a different grade **(3)**.

Use the **Slope left** field and the **Slope right** field to define the type of grade in one of the following ways:

- horizontal and vertical distance
- grade and slope distance
- grade and horizontal distance

The software reports your position relative to the arc and the vertical distance as a cut **(4)** or a fill **(5)** to the slope.



### Center point of arc

Stake out the center point **(1)** of a defined arc **(2)**.

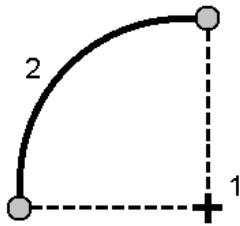

## To stake out an alignment

RXL alignment files can be created using:

- Origin Roads software.
- Survey Office software.
- A number of third party design packages including Autodesk AutoCAD Land Desktop, AutoCAD Civil 3D, Bentley InRoads, and Bentley GEOPAK.

When staking an alignment, you can work from the map or from the menu.

**NOTE** - You can stake a LandXML alignment only by selecting it from the map.

Before you start, configure your [navigation display settings](#). You can stake [relative to a DTM](#) or [the design elevation](#), if required.

### To select the alignment from the map

1. In the map, tap the alignment.

If the alignment you want to stake out is not shown in the map, tap  in the map toolbar to open the **Layer manager** and select the **Map files** tab. Select the file and then make the appropriate layer(s) visible and selectable. The file must be in the current project folder.

2. Tap **Stakeout**.

The **Stakeout** screen for the alignment appears.

3. Select the method in the **Stake** field. To stake out the alignment, refer to the topic for the selected method.



### To select the alignment from the Stakeout menu

1. Tap  and select **Stakeout / Alignments**.
2. In the **Select file** screen, select the alignment to stake.
3. To configure the software to return to the **Select file** screen when exiting the **Stakeout** menu instead of to the map, tap **Options**.
4. Tap **Next**.
5. Select the method in the **Stake** field. To stake out the alignment, refer to the topic for the selected method.

### To stake out to the alignment

1. In the **Stake** field, select **To the alignment**.
2. If required, enter a value in the **Construction offset** field. See [Construction offsets, page 539](#).
3. To change the target or antenna height, tap the target or antenna icon in the status bar.
4. Tap **Stakeout**.
5. [Stakeout navigation, page 503](#).

A dashed green line is drawn at a right angle from your current position to the alignment. The elevation of your current position and the design elevation of the computed position are shown.

To switch between the plan view and the cross section view, tap  or , or press the **Tab** key.

The cross section shows your current position and the target, and is orientated in the direction of increasing station. Construction offset(s) appear as green lines. If construction offsets are specified, the smaller single circle indicates the selected position and the double circle indicates the selected position adjusted for the construction offset(s).

6. When the point is within tolerance, tap **Measure** to measure the point.
7. Tap **Accept** to store the point.
8. If you selected the **View before storage** option, the staked deltas you selected in the **Stakeout options** screen are shown. Tap **Store**.



### To stake out a station on an alignment

1. In the **Stake** field, select **Station on alignment**.
2. Select a **Station** to stake and specify the **Station interval**.

To select the station you can:

- Tap ► to select the station from a list.
  - Key in a value.
  - Tap **Sta+** or **Sta-** to select the next/previous station.
3. If required, enter an **Offset**.
  4. To edit the design elevation, tap ►. See [To edit the design elevation, page 517](#).
  5. To define a construction offset, enter values in the **Construction offsets** fields.
  6. To change the target or antenna height, tap the target or antenna icon in the status bar.
  7. Tap **Stakeout**.
  8. [Navigate to the point](#).

The elevation of your current position and the design elevation of the computed position are shown.

To switch between the plan view and the cross section view, tap  or , or press the **Tab** key.

The cross section shows your current position and the target, and is orientated in the direction of increasing station. Construction offset(s) appear as green lines. If construction offsets are specified, the smaller single circle indicates the selected position and the double circle indicates the selected position adjusted for the construction offset(s).

9. When the point is within tolerance, tap **Measure** to measure the point.
10. Tap **Accept** to store the point.
11. If you selected the **View before storage** option, the staked deltas you selected in the **Stakeout options** screen are shown. Tap **Store**.

## To stake out the side slope from an alignment

1. In the **Stake** field, select **Side slope from alignment**.
2. Enter a value in the **String name** field (this step is optional).

**TIP** – The annotation entered in the **String name** field is assigned to the end of the side slope and is displayed during stakeout.

3. Select a **Station** to stake and specify the **Station interval**.

To select the station you can:



- Tap ► to select the station from a list.
  - Key in a value.
  - Tap **Sta+** or **Sta-** to select the next/previous station.
4. To define the hinge, select a **Hinge derivation** method and then complete the appropriate fields. See [Hinge derivation methods, page 541](#).

**NOTE** – If the alignment consists of only a horizontal alignment, the only hinge derivation method available is **Offset and elevation**.

5. Complete the appropriate fields to [define the side slope](#).
6. To define a construction offset, enter values in the **Construction offsets** fields.
7. To change the target or antenna height, tap the target or antenna icon in the status bar.
8. Tap **Stakeout**.
9. [Navigate to the point](#).

The elevation of your current position and the side slope value defined by your current position are shown.

When you are within 3 m of the target the plan view shows your current position along with the target. A dashed line connects the side slope catch position (the point where the side slope intersects with the ground) to the side slope hinge position.

To switch between the plan view and the cross section view, tap  or , or press the **Tab** key.



The cross section shows your current position and the target, and is orientated in the direction of increasing station. Construction offset(s) appear as green lines. If construction offsets are specified, the smaller single circle indicates the selected position and the double circle indicates the selected position adjusted for the construction offset(s).

If you are staking to a catch point with construction offsets, navigate to the catch point and then tap **Apply** to add the construction offsets. You are prompted to apply the offsets from your current position. If you are not on the catch position, select **No**, navigate to the catch position and then tap **Apply** again. To store the catch position and the construction offset, see Construction offsets.

10. When the point is within tolerance, tap **Measure** to measure the point.
11. Tap **Accept** to store the point.
12. If you selected the **View before storage** option, the staked deltas you selected in the **Stakeout options** screen are shown. Tap **Store**.

**NOTE** – To also stake the appropriate hinge position, tap **Select>>** and select the **Hinge point (Cut)** or **Hinge point (Fill)** option.

#### To stake out a station at a skew offset from an alignment

1. In the **Stake** field, select **Station/skew offset from alignment**.
2. Select a **Station** to stake and specify the **Station interval**.

To select the station you can:

- Tap **►** to select the station from a list.
- Key in a value.
- Tap **Sta+** or **Sta-** to select the next/previous station.

3. Enter skew and offset values.

As shown in the diagram below, the point to stake (1) is defined from the station (3) by an offset (5) along the skew (2). The skew can be defined by a forward or backward delta angle to a line (6) at right angles to the alignment being staked (4), or the skew can be defined by an azimuth. The diagram shows a point defined by skew forward and offset to the right.

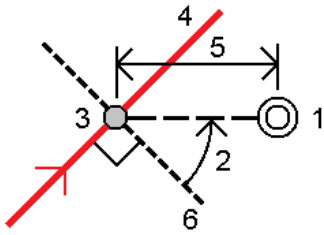

4. The elevation for the point can be defined by:
- **Slope from alignment** – the elevation is computed by a slope from the elevation of the alignment at the entered station.
  - **Delta from alignment** – the elevation is computed by a delta from the elevation of the alignment at the entered station.
  - **Key in** – the elevation is keyed in.

If the alignment only has a horizontal alignment, the elevation for the point must be keyed in.

5. To define a construction offset, enter values in the **Construction offsets** fields.

**NOTE** – *If the computed position is before the start or beyond the end of the alignment the point cannot be staked.*

6. To change the target or antenna height, tap the target or antenna icon in the status bar.
7. Tap **Stakeout**.
8. [Navigate to the point](#).

The elevation of your current position, the design elevation of the selected position, and the skew offset and delta information are shown.

**NOTE** – *When staking a station at a skew offset, the cross section view is unavailable.*

9. When the point is within tolerance, tap **Measure** to measure the point.
10. Tap **Accept** to store the point.
11. If you selected the **View before storage** option, the staked deltas you selected in the **Stakeout options** screen are shown. Tap **Store**.

## To offset an alignment

1. Tap  and select **Stakeout / Alignments**.
2. In the **Select file** screen, select the alignment to stake.
3. Tap **Offset** in the **Select file** screen.
4. Enter the offset distance. To offset to the left, enter a negative value.
5. Select the **Store offset alignment** check box and enter the **Alignment name**.
6. Enter the **String name**.
7. To store node points at the vertices of the offset alignment, select the **Store points at nodes** check box and enter the **Start point name** and the **Code**, if required.
8. Tap **Store**.

**NOTE** - An offset alignment has a vertical component if the vertical geometry of the original alignment coincides with the horizontal geometry and the vertical geometry consists only of points. The offset vertical geometry cannot include curves. If the vertical geometry of an alignment cannot be offset, only the horizontal component will exist in the offset alignment. You cannot offset an alignment that includes transitions.

## Construction offsets

A point to be staked can be offset by a horizontal or a vertical offset.

During stakeout a construction offset is indicated by a green line, with the double circle indicating the selected position adjusted for the specified construction offset(s).

When you define a construction offset for an alignment, the offset is:

- used for all alignments in the same job.
- used for all subsequent surveys of the alignment in the same job, until a different construction offset is defined.
- not used for the same alignment when it accessed from a different job.

### Horizontal construction offsets

When staking stations on the alignment or at a skew offset from the alignment, you can define a horizontal construction where:

- A negative value offsets points to the left of the alignment.
- A positive value offsets points to the right of the alignment.

**NOTE** – When staking a station at a skew offset from the alignment, the horizontal construction offset is applied along the skew, not at right angles to the alignment.

When staking stations offset from the alignment or when staking a side slope, you can define a horizontal construction where:

- A negative value offsets points toward the alignment (in).
- A positive value offsets points away from the alignment (out).

When staking a catch point, tap ► next to the **Horizontal offset** field to specify if the offset is to be applied:

- Horizontally
- At the slope of the previous element in the cross section

**NOTE** – Construction offsets are not automatically applied to a side slope offset. When you stake a side slope, select the **Store both catch and construction offset** check box to measure and store the catch position. See *Catch point*.

The following diagram shows a **Horizontal offset (1)** and **Slope previous offset (2)** applied to the catch point **(3)**. For the **Slope previous** option, the slope of the offset is defined by the slope of the side slope **(4)**. The **Vertical offset** value in the diagram is 0.000.

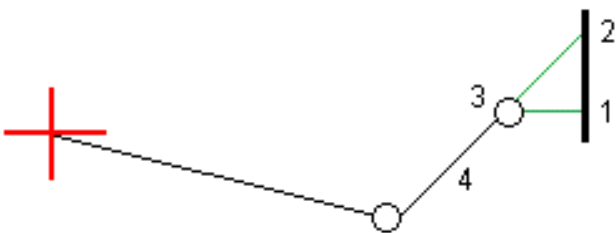

**NOTE** – For points with zero offset, you cannot apply construction horizontal offsets at the slope value of the previous template element.

### Vertical construction offsets

You can define a vertical construction offset where:

- A negative value offsets points vertically down.
- A positive value offsets points vertically up.

When staking a side slope from the alignment, tap  next to the **Vertical offset** field to specify if the offset is to be applied:

- Vertically
- Perpendicular to the element in the cross section before the point being staked

The following diagram shows a **Vertical offset** applied vertically **(1)** and a **Vertical offset** applied perpendicular **(2)** to the side slope **(3)**.

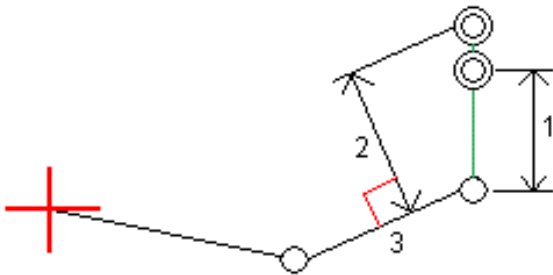

### Hinge derivation methods

Select one of the **Hinge derivation** methods illustrated below:

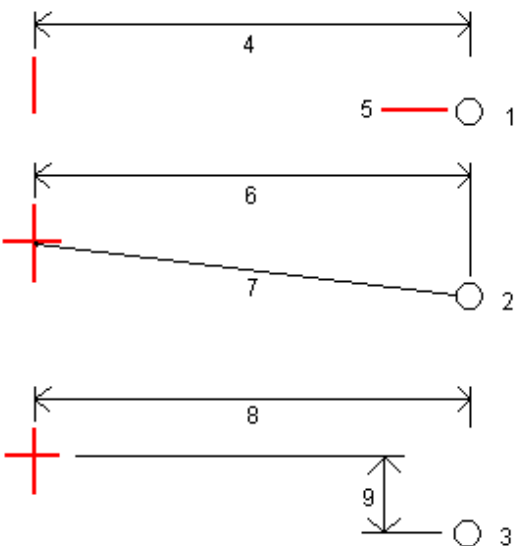

**1 – Offset and elevation.** Enter an offset **(4)** from the horizontal alignment, and the elevation **(5)** of the hinge position.

**2 – Offset and slope.** Enter an offset **(6)** from the horizontal alignment, and the slope value **(7)** from the intersection of the horizontal and vertical alignments to the hinge position.

**3 – Offset and vertical distance.** Enter an offset **(8)** from the horizontal alignment, and the vertical difference **(9)** from the intersection of the horizontal and vertical alignments to the hinge position.

### Side slope definition

Enter the **Cut slope (1)**, **Fill slope (2)**, and **Cut ditch width (3)** values.

**NOTE** – Cut and fill slopes are expressed as positive values. You cannot add a string after a side slope.

To define a side slope with only a cut or fill slope, leave the other slope value field as '?'.

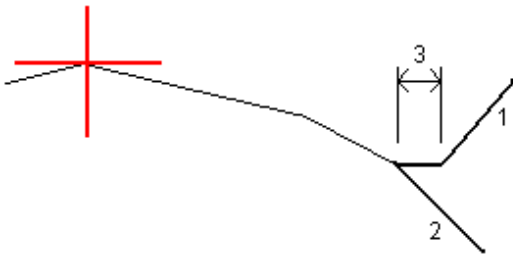

### Catch point

The catch point is the point where the design side slope intersects with the ground.

The actual intersection position of the side slope with the existing ground surface – the catch point – is determined iteratively (by repetition). The software calculates the intersection of a horizontal plane passing through the current position, and either the cut or fill side slope, as shown in the following diagram, where  $x_n$  is the **Go Right/Left** value.

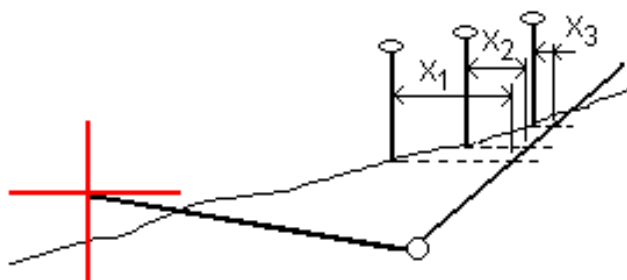

The plan view shows the calculated catch position. The calculated slope value (in blue) and the design slope value appears at the top of the screen.

The cross section is displayed looking in the direction of increasing station. Your current position and the calculated target are indicated. A line is drawn (in blue) from the hinge position to your current position to indicate the calculated slope.

Green lines indicate if the catch point has construction offsets specified. The smaller single circle indicates the calculated catch position and the double circle indicates the selected position adjusted for the specified construction offset(s). The construction offsets appear only after you have applied them.

### Catch point staked deltas

To configure the display of staked information on the **Confirm staked deltas** screen that appears before the point is stored if you have enabled **View before storage**, see [As-staked point details](#).

To view the **Catch point deltas report** screen, tap **Report** in the **Confirm staked deltas** screen or **Review job** screen.

The horizontal and vertical distances from the hinge and the centerline are shown. If the side slope includes a cut ditch, the report includes the hinge position at the toe of the cut slope. The reported values exclude any construction offset specified.

See the diagram below:

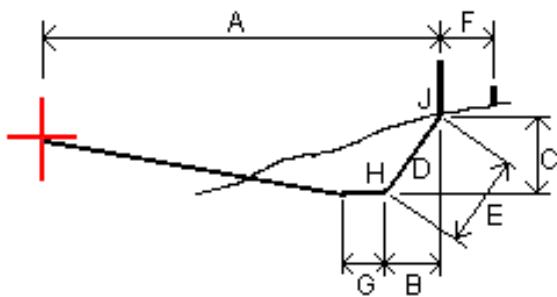

Where:

- A = Distance to centerline
- B = Horizontal distance to hinge point
- C = Vertical distance to hinge point
- D = Slope
- E = Slope distance to hinge point
- F = Horizontal construction offset
- G = Ditch offset
- H = Hinge point

J = Catch point

**NOTE** – The value in the **S.Distance to hinge + Constr offset** field includes any construction offset values specified and reports the slope distance from the hinge to the as-staked position. The value is null (?) if there is no horizontal construction offset specified or the horizontal construction offset is applied horizontally.

### Station field abbreviations

The Origin software uses the following abbreviations in the **Station** field pop-up menu.

Abbreviation	Meaning
AE	End
AS	Start
CS	Curve to transition
Lo	Vertical curve low point
Hi	Vertical curve high point
PC	Point of curvature (tangent to curve)
PI	Point of intersection
PT	Point of tangent (curve to tangent)
SC	Transition to curve
SS	Transition to transition
ST	Transition to tangent
TS	Tangent to transition
VCE	Vertical curve end
VCS	Vertical curve start
VPI	Vertical point of intersection
XS	Regular sections

### To stake out to the design elevation

To measure your position relative to an elevation in an RTK or conventional survey:

1. Tap  and select **Stakeout / Elevation**.
2. Enter the **Design elevation**.



3. Enter the **As-staked name** and **Code**.
4. Enter a value in the **Antenna height** or **Target height** field and make sure that the **Measured to** field is set correctly.
5. Tap **Start**.



The coordinates of the current position and the distance above (cut) or below (fill) the design elevation are shown.

**NOTE** – *Unless you are using a conventional instrument that supports tracking, the values appear only after you have taken a distance measurement.*

6. When the point is within tolerance, tap **Measure** to measure the point.
7. Tap **Accept** to store the point.
8. If you selected the **View before storage** option, the staked deltas you selected in the **Stakeout options** screen are shown. Tap **Store**.

## To show the cut/fill to a DTM during stakeout

When staking out a point, line, arc, polyline, or alignment it can be useful to display the cut/fill to a [digital terrain model \(DTM\)](#), where the horizontal navigation is relative to the item you are staking but the displayed cut/fill delta value is from your current position to the DTM.

1. Tap  and select **Stakeout** / [feature type].
2. Tap the **Options** softkey.
3. In the **Deltas** group box, tap **Edit** and select the **V.Dist DTM** delta and, if required, the **DTM elevation** delta. Tap **Accept**.
4. In the **DTM** group box, select the DTM.
5. If required, in the **Offset to DTM** field, specify an offset to the DTM. Tap  and select whether the offset is to be applied vertical or perpendicular to the DTM. The **V.Dist DTM** value is to the offset position.
6. Stake out the road as usual.

**NOTE** – *When a horizontal construction offset is applied, the cut/fill value reported is to the DTM at the position selected for stakeout and not to the DTM at your current position.*

When viewing the cross section, the DTM is displayed at your current position as a green line. A circle on the DTM indicates your position projected vertically to the surface.

## To stake out a DTM

For information on supported DTMs, see [DTMs and surfaces, page 136](#).

1. Tap **Stakeout / DTMs**.
2. Select the file to be used.

***NOTE** - All DTM files in the current project folder are listed.*

3. If required, in the **Offset to DTM** field, specify an offset to the DTM. Tap ► and select whether the offset is to be applied vertical or perpendicular to the DTM. The **V.Dist DTM** value is to the offset position.
4. To change the target or antenna height, tap the target or antenna icon in the status bar.

If the target or antenna height have not been defined, the elevation and cut/fill will be null (?).

5. Tap **Start**.

The coordinates of the current position and the distance above (cut) or below (fill) the DTM are shown.

***NOTE** - Unless you are using a conventional instrument that supports tracking, the values appear only after you have taken a distance measurement.*

6. When the point is within tolerance, tap **Measure** to measure the point.
7. Tap **Accept** to store the point.
8. If you selected the **View before storage** option, the staked deltas you selected in the **Stakeout options** screen are shown. Tap **Store**.

When staking out the DTM, if you are outside the extent of the DTM or in a "hole", the DTM elevation and cut/fill will be null (?).

## Glossary

This topic explains some of the terms used in this Help.

### **accuracy**

The closeness of a measurement or coordinate value to the actual (true) or accepted value.

### **alignment**

Alignments can be defined in the Origin Roads or Survey Office software, or a number of third-party design packages including Autodesk AutoCAD Land Desktop, AutoCAD Civil 3D, Bentley InRoads, and Bentley GEOPAK. Alignments are stored as RXL files and can be easily shared between jobs and with other controllers.

### **almanac**

Data, transmitted by a GNSS satellite, that includes orbit information on all the satellites, clock correction, and atmospheric delay parameters. The almanac facilitates rapid satellite acquisition. The orbit information is a subset of the ephemeris data with reduced precision.

### **Angles and distance**

Measurement of horizontal and vertical angles and a slope distance.

### **Angles only**

Measurement of horizontal and vertical angles.

### **annotation**

Markings on images for the purpose of clarification.

### **attribute**

A characteristic or property of a feature in a database. All features have a geographic position as an attribute. Other attributes depend on the type of feature. For example, a road has a name or designation number, surface type, width, number of lanes, and so on. Each attribute has a range of possible values, called a domain. The value chosen to describe a particular feature is called the attribute value.

### **Autolock**

The ability to lock onto and track a target.

### **automated rounds**

The process of automatically measuring a multiple observations to observed points.

**autonomous positioning**

The least precise form of positioning that a GNSS receiver can produce. The position fix is calculated by one receiver from satellite data alone.

**azimuth**

Horizontal direction relative to a defined coordinate system.

**backsight**

Point with known coordinates or known azimuth from the instrument point that is used to orientate the instrument during station setup.

**base station**

In a GNSS survey, you observe and compute baselines (the position of one receiver relative to another). The base station acts as the position from which all unknown positions are derived. A base station is an antenna and receiver set up on a known location specifically to collect data to be used in differentially correcting rover files.

**baud**

A unit of data transfer speed (from one binary digital device to another) used in describing serial communications; generally one bit per second.

**BIM**

Building Information Modeling (BIM) is a process where the planning, design, construction, and maintenance of buildings and other built assets such as roads, bridges or utilities infrastructure is managed using digital 3D models. BIM file formats supported in Origin are IFC and DXF.

**C/A (Coarse Acquisition) code**

A pseudorandom noise (PRN) code modulated onto an L1 signal. This code helps the receiver compute the distance from the satellite.

**change face**

Refers to when the face of the conventional instrument that is measuring observations changes between face 1 and face 2. On a [servo instrument](#), this happens automatically. On a [robotic instrument](#), this happens when you tap **Change face** in the Origin software. On a [mechanical instrument](#), you must manually change face on the instrument.

**CMR**

Compact Measurement Record. A satellite measurement message that is broadcast by the base receiver and used by RTK surveys to calculate an accurate baseline vector from the base to the rover.

**constellation**

A specific set of satellites used in calculating positions: three satellites for 2D fixes, four satellites for 3D fixes. All satellites visible to a GNSS receiver at one time. The optimum constellation is the constellation with the lowest PDOP. See also [PDOP](#).

**construction offsets**

A specified horizontal and/or vertical offset distance to enable equipment to operate without disturbing construction stakes.

**construction point**

A point that is measured using the "quick fix" option in COGO.

**control point**

A point on the earth that has an accurately known geographic position.

**conventional survey**

In a conventional survey, the controller is connected to a conventional survey instrument such as a total station.

**curvature and refraction**

Correction to the measured vertical angle for the curvature of the earth and the refraction caused by the earth's atmosphere.

**data message**

A message, included in the GNSS signal, that reports on the location and health of the satellites as well as any clock correction. It includes information about the health of other satellites as well as their approximate position.

**datum**

See [geodetic datum](#) and [local datum](#).

**design code**

The code name given to the design point.

**design name**

The name given to the design point.

**Differential Positioning**

Precise measurement of the relative position of two receivers tracking the same satellites simultaneously.

**Direct Reflex (DR)**

Type of EDM that can measure to non reflective targets.

**displacement model**

A model of the movement of points on the surface of the Earth due to plate motion, tectonic strain accumulation, seismic/postseismic deformation, glacial isostatic adjustment, and/or other geological or anthropogenic processes that cause significant coordinate change over large areas. Used to propagate coordinates from one epoch (such as the epoch of measurement) to another (such as the reference epoch of the selected global reference datum).

### **DOP (Dilution of Precision)**

An indicator of the quality of a GNSS position. DOP takes into account the location of each satellite relative to other satellites in the constellation, as well as their geometry relative to the GNSS receiver. A low DOP value indicates a higher probability of accuracy. Standard DOPs for GNSS applications are:

- PDOP - Position (three coordinates)
- GDOP - Geometric (three coordinates and time)
- RDOP - Relative (Position, averaged over time)
- HDOP - Horizontal (two horizontal coordinates)
- VDOP - Vertical (height only)
- TDOP - Time (clock offset only)

### **Doppler shift**

The apparent change in frequency of a signal caused by the relative motion of satellites and the receiver.

### **DTM**

Digital Terrain Model. A digital representation of the shape of a surface in three dimensions. The represented surface may be an existing terrain, proposed grade surfaces, or a combination of both. Types of DTM include gridded terrain models (.dtm), triangulated terrain models (.ttm), and triangulated DTMs in a LandXML file.

### **dual-frequency**

GNSS receiver that uses both L1 and L2 signals from GNSS satellites. A dual-frequency receiver can compute more precise position fixes over longer distances and under more adverse conditions because it compensates for ionospheric delays.

### **dual-prism offset**

Measurement of horizontal and vertical angles and a slope distance to two prisms located on one prism pole for the purpose of positioning an obstructed point.

### **DXF file**

A **DXF file** is a 2D or 3D vector graphic file format generated from CAD software such as AutoDesk. DXF stands for Drawing Exchange Format.

### **Earth-Centered, Earth-Fixed (ECEF)**

A cartesian coordinate system expressing coordinates in the **Global** datum. The center of this coordinate system is at the earth's center of mass. The z axis is coincident with the mean rotational axis of the earth and the x axis passes through 0° N and 0° E. The y axis is perpendicular to the plane of the x and z axes.

**eccentric object**

Measurement of horizontal and vertical angles and a slope distance to the face of a radial object (for example, power pole). An additional horizontal angle is observed to the side of the object to calculate the radius and thus position the center of the object.

**EGNOS**

European Geostationary Navigation Overlay Service . A satellite-based augmentation system (SBAS) that provides a free-to-air differential correction service for GNSS.

**elevation**

Height above mean sea level. Vertical distance above the geoid.

**elevation mask**

The angle below which Spectra Geospatial recommends that you do not track satellites. Normally set to 10 degrees to avoid interference from buildings and trees as well as ground multipath errors.

**ellipsoid**

A mathematical model of the earth formed by rotating an ellipse around its minor axis.

**ephemeris**

The current satellite position predictions (trajectory), transmitted in the data message.

**epoch**

The measurement interval of a GNSS receiver. The epoch varies according to the survey type: – for real-time surveys it is set at one second – for postprocessed surveys it can be set to a rate of between one second and one minute

**face 1**

Observing position of an instrument where the vertical circle is commonly on the left hand side of the telescope.

**face 2**

Observing position of an instrument where the vertical circle is commonly on the right hand side of the telescope.

**FastStatic survey**

A type of GNSS survey. A FastStatic survey is a postprocessed survey using occupations of up to 20 minutes to collect raw GNSS data. The data is postprocessed to achieve subcentimeter precisions.

**feature**

A representation of a real-world object on a map. Features can be represented as points, lines, or polygons. Multipoint features consist of more than one point but only reference one set of attributes in the database.

**feature codes**

Simple descriptive words or abbreviations that describe the features of a point.

**fixed solution**

Indicates that the integer ambiguities have been resolved and a survey is initialized. This is the most precise type of solution.

**float solution**

Indicates that the integer ambiguities have not been resolved, and that the survey is not initialized.

**FSTD (fast standard)**

The method of measuring one distance and one angle to coordinate a point.

**GAGAN**

GPS Aided Geo Augmented Navigation. A regional satellite-based augmentation system (SBAS) implemented by the Indian government.

**Galileo**

Galileo is a global navigation satellite system (GNSS) built by the European Union (EU) and European Space Agency (ESA). Galileo is an alternative and complementary GNSS to the U.S. Global Positioning System (GPS), the Russian GLONASS, and the Japanese Quasi-Zenith Satellite (QZSS).

**GDOP**

Geometric Dilution of Precision. The relationship between errors in user position and time, and errors in satellite range. See also [DOP](#).

**GENIO**

GENeric Input Output file exported by a number of road design software packages that defines a road as a series of strings. See also [string](#).

**geodetic datum**

A mathematical model designed to fit part or all of the geoid (the physical earth's surface).

**geoid**

The surface of gravitational equipotential that closely approximates mean sea level.

**Global**

**Global** is the short form name to refer to coordinates in the **Global reference datum**.

**Global reference datum**



The **Global reference datum** is the datum of RTK measurements, such as the reference frame of base stations including VRS. The Origin software determines the **Global reference datum** using the coordinate system and zone you have selected from the coordinate system library.

If you perform an RTK survey in the job, you must make sure the selected real-time correction source is providing GNSS positions in the same datum as that specified in the **Global reference datum** field in the **Select coordinate system** screen of the job properties.

### **Global reference epoch**

The **Global reference epoch** is the epoch of realization of the **Global reference datum**. The Origin software determines the **Global reference epoch** using the coordinate system and zone you have selected from the coordinate system library.

### **GLONASS**

GLObal NAVigation Satellite System (GLONASS) is the global navigation satellite system (GNSS) operated for the Russian government by the Russian Space Forces. GLONASS is an alternative and complementary GNSS to the U.S. Global Positioning System (GPS), the European Union Galileo positioning system, and the Japanese Quasi-Zenith Satellite (QZSS).

### **GNSS**

Global Navigation Satellite System (GNSS). This is the standard generic term for satellite navigation systems that provide geospatial positioning with global coverage.

### **GNSS survey**

In a GNSS survey, the controller is connected to a GNSS receiver.

### **GPS**

Global Positioning System (GPS) is the global navigation satellite system (GNSS) operated U.S. government. GPS is an alternative and complementary GNSS to the GLObal NAVigation Satellite System (GLONASS), the European Union Galileo positioning system, and the Japanese Quasi-Zenith Satellite (QZSS).

### **GPS time**

A measure of time used by the NAVSTAR GPS system.

### **H. Angle offset**

Measurement of vertical angle and slope distance. Horizontal angle is then measured separately, usually to an obstructed point.

### **H. Angle only**

Measurement of horizontal angle.

### **HDOP**

Horizontal Dilution of Precision. See also [DOP](#).

### **Helmert adjustment**

A Helmert transformation is a coordinate transformation which uses rotation, scaling, and translation. The horizontal adjustment in a GNSS site calibration is a 2D form of Helmert transformation, and it can also be used for computing a resection.

### **horizontal circle**

Graduated or digital disc from which the horizontal angle is measured.

### **IFC files**

IFC files are Industry Foundation Class files. They contain BIM models that can be used for surveying fieldwork including stakeout and cogo calculations. Origin supports IFC files in the .ifc or .ifczip file format.

### **instrument height**

Height of the instrument above the instrument point.

### **instrument point**

Point that the instrument is occupying.

### **integer ambiguity**

The whole number of cycles in a carrier phase pseudorange between the GNSS satellite and the GNSS receiver.

### **integrated survey**

In an integrated survey, the controller is connected to both a conventional survey instrument and a GNSS receiver at the same time. The Spectra Geospatial Origin software can quickly switch between the two instruments, within the same job.

### **ionosphere**

The band of charged particles 80 to 120 miles above the earth's surface. The ionosphere affects the accuracy of GNSS measurements if you measure long baselines using single-frequency receivers.

### **K factor**

The K factor is a constant defining a vertical curve in a road definition.

$K = L/A$ . where:

L is the length of the curve

A is the algebraic difference between the incoming and outgoing slopes in %.

### **L1**

The primary L-band carrier used by GNSS satellites to transmit satellite data.

### **L2**

The secondary L-band carrier used by GNSS satellites to transmit satellite data. Block IIR-M and later GPS satellites will transmit an additional signal on L2 called L2C.

## **L5**

The third L-band carrier used by GNSS satellites to transmit satellite data. This has been added to Block IIF and later GPS satellites.

## **LandXML file**

A **LandXML file** is an XML file format for civil engineering design and survey measurement data such as points, surfaces, parcels, pipe network data and alignments.

## **Local datum**

The Origin software determines the **Local datum** using the coordinate system and zone you have selected from the coordinate system library.

## **measurement modes**

Angles are measured and averaged as one distance is measured using one of the following measurement modes: Standard (STD), Fast Standard (FSTD), Tracking (TRK). STD mode is indicated by an S next to the instrument icon on the status bar. One angle and one distance are measured. FSTD mode is indicated by an F next to the instrument icon on the status bar. Angles and distances are continually measured. TRK mode is indicated by a T next to the instrument icon on the status bar.

## **mechanical instrument**

A conventional instrument that must be manually turned to change face or to locate targets. Compare with [servo instrument](#).

## **MGRS**

Military Grid Reference System

## **MSAS**

MTSAT Satellite-Based Augmentation System. A satellite-based augmentation system (SBAS) that provides a free-to-air differential correction service for GNSS over its coverage area, which is Japan.

## **multipath**

Interference, similar to ghosting on a television screen. Multipath occurs when GNSS signals traverse different paths before arriving at the antenna.

## **neighborhood adjustment**

A coordinate adjustment that is applied to conventional surveys with multiple backsights or jobs with a GNSS site calibration. During station setup plus, resection or GNSS site calibration, residuals are calculated for each observed control point. The calculated distances from each new point to the control points used in the station setup or calibration are used to determine the coordinate

adjustment to be applied to the new point.

**NMEA**

A standard, established by the National Marine Electronics Association (NMEA), that defines electrical signals, data transmission protocol, timing, and sentence formats for communicating navigation data between marine navigation instruments.

**NTRIP**

Networked Transport of RTCM via Internet Protocol

**observation**

A measurement made at or between points using surveying equipment, including GNSS receivers and conventional instruments.

**P-code**

The 'precise' code transmitted by the GPS satellites. Each satellite has a unique code that is modulated onto both the L1 and L2 carrier waves.

**parity**

A form of error checking used in binary digital data storage and transfer. Options for parity checking include Even, Odd, or None.

**PDOP**

Position Dilution of Precision, a unitless figure of merit expressing the relationship between the error in user position and the error in satellite position.

**PDOP mask**

The highest PDOP value at which a receiver will compute positions.

**polyline**

Polylines are two or more lines or arcs connected together. A line is a single line between two points.

**positioning system**

A system of instrumental and computational components for determining geographic position.

**postprocess**

To process satellite data on a computer after it has been collected.

**postprocessed kinematic survey**

A type of GNSS survey. Postprocessed kinematic surveys store raw stop-and-go and continuous observations. The data is postprocessed to achieve centimeter-level precisions.

**PPM**

Parts per million correction that is applied to measured slope distances to correct for the affects of the earth's atmosphere. PPM is determined using observed pressure and temperature readings together with specific instrument constants.

**precision**

A measure of how closely random variables tend to cluster around a computed value, which indicates the repeatability of one or a set of measurements.

**prism constant**

Distance offset between the center of a prism and the point being measured.

**projection**

Used to create flat maps that represent the surface of the earth or parts of that surface.

**QZSS**

Quasi-Zenith Satellite (QZSS) is a Japanese based satellite system built by the Japan Aerospace Exploration Agency (JAXA). QZSS is a complementary GNSS to the U.S. Global Positioning System (GPS), the Russian GLONASS, and the European Union Galileo positioning system. QZSS is also a satellite-based augmentation system (SBAS).

**RDOP**

Relative Dilution of Precision. See also [DOP](#).

**real-time differential survey**

A type of GNSS survey. A real-time differential survey uses the differential corrections transmitted from a land-based receiver or from SBAS satellites to achieve submeter positioning at the rover.

**real-time kinematic and data logging survey**

A type of GNSS survey. A real-time kinematic and data logging survey records raw GNSS data during an RTK survey. The raw data can be postprocessed later, if required.

**real-time kinematic and infill survey**

A type of GNSS survey. A real-time kinematic and infill survey allows you to continue a kinematic survey when radio contact with the base station is lost. The infill data must be postprocessed.

**reference station**

See [base station](#).

**refline**

The process of establishing the position of an occupied point relative to a baseline by taking measurements to two known or unknown points.

**region**

A region contains scan points from one or more .rcwx scan point clouds or from other regions. Create a region to include only the scan points you are most interested in. A region is especially useful when performing a [surface inspection](#).

**resection**

The process of establishing the position of an occupied point by taking measurements to two or more known points.

**RMT**

Remote target

**robotic survey**

A survey in which the controller running the Origin software is connected via radio to a conventional instrument, so that the instrument can be controlled robotically from the Origin software.

**rounds**

Conventional observation method of multiple observations to multiple points.

**rover**

Any mobile GNSS receiver and field computer collecting data in the field. The position of a roving receiver can be differentially corrected relative to a stationary base GNSS receiver.

**RTCM**

Radio Technical Commission for Maritime Services. This is a commission that was established to define a differential data link for the real-time differential correction of roving GNSS receivers.

**RTK**

Real-time kinematic, a type of GNSS survey.

**SBAS**

Satellite Based Augmentation System. SBAS is based on differential GNSS, but applies to wide area networks of reference stations (for example, (WAAS, EGNOS, MSAS). Corrections and additional information are broadcast using geostationary satellites.

**servo instrument**

A conventional instrument that is equipped with servo motors, which enables the instrument to change face and turn to track targets automatically. Compare with a [mechanical instrument](#).

If the servo instrument is also equipped with a radio, you can use it in a [robotic survey](#), where the instrument is controlled via the Origin software.

**Shapefile**

A **Shapefile** is an ESRI vector data storage format for storing geographic features as points, lines, or polygons as well as attribute information.

**single-frequency**

A type of receiver that only uses the L1 GNSS signal. There is no compensation for ionospheric effects.

**single distance offset**

Measurement of horizontal and vertical angles and a slope distance. Plus additional offset distances to position obstructed points.

**SNR**

Signal-to-Noise Ratio, a measure of the strength of a satellite signal. SNR ranges from 0 (no signal) to 99, where 99 is perfect and 0 means the satellite is not available. A typical good value is 40. A GNSS system typically starts using a satellite when its SNR value is higher than 25.

**station**

The distance or interval along a line, arc, alignment, or road.

**station setup**

The process of defining the instrument occupation point and setting the orientation of the instrument to a backsight point or points.

**string**

A string is a series of 3D points joined together. Each string represents a single feature such as a curb line or the centerline of a road.

**surface**

A surface is a 3D digital representation of topography, formed by a mesh of contiguous triangles, which is stored as a Trimble Terrain Model (TTM) file.

**surface inspection**

The **Surface Inspection** Cogo function compares the scan point cloud of an as-built surface with a reference surface and calculates the distance to the reference surface for each scan point to create an inspection point cloud. The selected reference surface can be a horizontal plane, vertical plane, inclined plane, cylinder, another scan, or an existing surface file such as a DTM, TTM, IFC, or RXL file. You can create a [region, page 557](#) to include in the inspection only the scan points you are interested in.

**superelevation**

In terms of a road design, superelevation refers to the addition of an extra slope (banking) on curves of the road to assist vehicles negotiating the curves. Adding superelevation assists in achieving the required design speed for the curve. Superelevation is generally defined in conjunction with [widening, page 561](#).

**SV**

Satellite Vehicle (or Space Vehicle).

**target height**

Height of prism above the point being measured.

**TDOP**

Time Dilution of Precision. See also [DOP](#).

**TOW**

Time of Week in seconds, from midnight Saturday night/Sunday morning GPS time.

**tracking**

The process of receiving and recognizing signals from a satellite.

**tracking mode**

Used to measure towards moving targets.

**Tracklight**

A visible light that guides the prism operator on the correct bearing.

**traverse**

A traverse is formed by surveying a number of points at traverse stations and then linking them into a circuit. A closed traverse is formed when the circuit ends at the starting point. It is useful for surveying large areas which are defined by a boundary. An open traverse is formed when the circuit ends at a different point to the starting point. It is useful for surveying a narrow strip of land such as a coastline or a corridor for a road.

A valid traverse station has one or more backsight observations to the previous traverse station, and one or more observations to the next traverse station. To compute a traverse closure, there must be at least one distance measurement between successive points used in the traverse.

**Trimble Terrain Model**

A Trimble Terrain Model (TTM) file represents a 3D terrain surface model as a mesh of contiguous triangles.

**TRK**

See [tracking mode](#).

**TTM**

See [Trimble Terrain Model](#).

**USNG**

United States National Grid

**UTC**

Universal Time Coordinated. A time standard based on local solar mean time at the Greenwich meridian. See also [GPS time](#).

**VBS**



Virtual Base Station.

**VDOP**

Vertical Dilution of Precision. See also [DOP](#).

**vertical circle**

Graduated or digital disc from which the vertical angle is measured.

**VPI**

Vertical Point of Intersection.

**WAAS**

Wide Area Augmentation System. A satellite-based augmentation system (SBAS) that improves the accuracy and availability of the basic GNSS signals over its coverage area, which includes the continental United States and outlying parts of Canada and Mexico.

**Weight exponent**

The Weight exponent is used in the neighborhood adjustment calculation. When the coordinate adjustment to be applied to a new point is calculated, the calculated distances from each new point to the control points used in the station setup are weighted according to the Weight exponent.

**widening**

In terms of a road design this refers to the widening of the road around a curve to provide extra safety for cars negotiating the curve. Widening is generally defined in conjunction with [superelevation, page 559](#).

**WGS-84**

World Geodetic System (1984), the mathematical ellipsoid used by GPS since January 1987. See also [ellipsoid](#).